

Kürzen der Stahlflex-Leitung How to cut the braided hose Comment couper la durite tressée?



MAGURA Bike Parts GmbH & Co.
Heinrich Kahn Straße 24
D-89150 Laichingen
phone ++49-(0)7333/9626-0
fax ++49-(0)7333/9626-17
info@magura-bikeparts.de

Hotline/Helpdesk:
phone ++49-(0)7125/153-180
fax ++49-(0)7125/153-184
service@magura.de
www.magura.com

MAGURA USA
phone 6183952200
fax 6183954711
magura@magura.com
www.magura.com

MAGURA Service Centre UK
phone 01530/837195
fax 01530/811286
service_UK@magura.de
www.magura.com

MAGURA Service Center France
phone 01 69916156
fax 01 69916156
sav_france@magura.de
www.magura.com

Achtung:
Überlassen Sie das Kürzen
der Leitung im Zweifelsfalle Ihrem
MAGURA-Fachhändler.

Attention:
The cutting of the hose should
only be done by your bike shop.

Attention:
Le raccourcissement de la durite
tressée ne doit être fait que par
votre spécialiste MAGURA agréé.

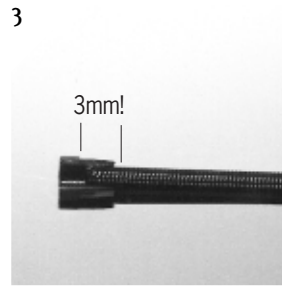
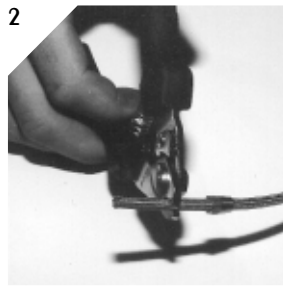
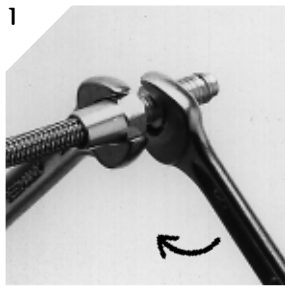

Bowdenzugzange zum Kürzen verwenden!
Use a cable cutter to shorten the hose!
Utiliser une pince coupe câble pour raccourcir la durite!

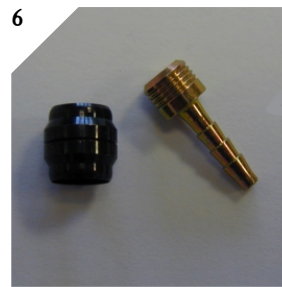
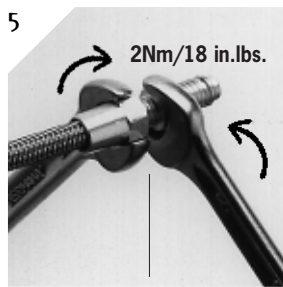
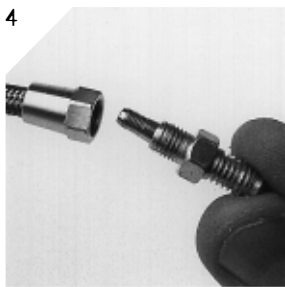

Nicht überdrehen!
Do not overtighten!
Ne pas trop serrer!

Bei der Stahlflexleitung nicht notwendig!
Not necessary with the braided hose!
Ne pas nécessaire avec la durite tressée!

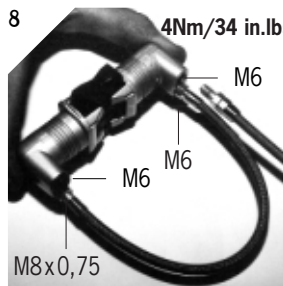
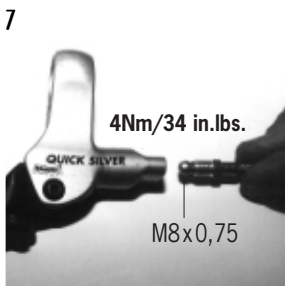

MAGURA: Kompatibel?/compatible?

HS 11	-
HS 12	✓
HS 22	✓
HS 24	✓
HS 33	✓
HS 66	-
HS 77	-

Anschluß Felgenbremsen
rim brake connection
montage sur les freins sur jante

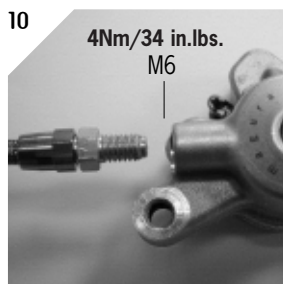
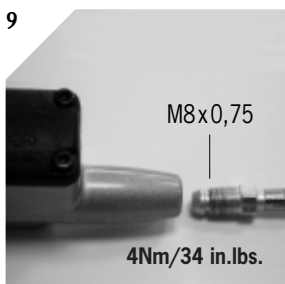

MAGURA: Kompatibel?/compatible

	0°-Kit (0721 203)	90°-Kit (0721 337)
--	----------------------	-----------------------

Gustav M	✓	✓
Marta	✓	-
Louise FR	✓	-
Louise	✓	-
Clara 2000 *	-	-
Clara 2001 →	✓	-
Julie	✓	-

Anschluß Scheibenbremsen
disc brake connection
montage sur les freins à disque

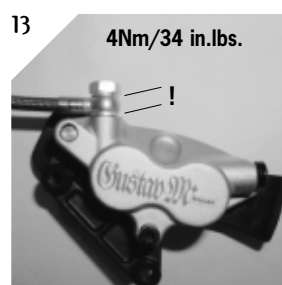
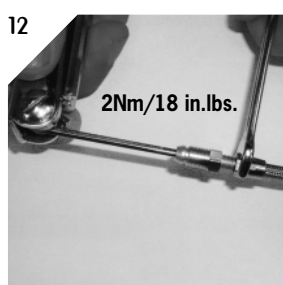

Dichtscheiben nicht vergessen!
Do not forget washers!
Ne pas oublier les entretoises!

***Rückseite beachten! / See backside! / Voir verso!**

Join the Brake People!



MAGURA Bike Parts GmbH & Co.
Heinrich Kahn Straße 24
D-89150 Laichingen
phone ++49-(0)7333/9626-0
fax ++49-(0)7333/9626-17
info@magura-bikeparts.de

Hotline/Helpdesk:
phone ++49-(0)7125/153-180
fax ++49-(0)7125/153-184
service@magura.de
www.magura.com

MAGURA USA
phone 6183952200
fax 6183954711
magura@magura.com
www.magura.com

MAGURA Service Centre UK
phone 01530/837195
fax 01530/811286
service_UK@magura.de
www.magura.com

MAGURA Service Center France
phone 01 69916156
fax 01 69916156
sav_france@magura.de
www.magura.com

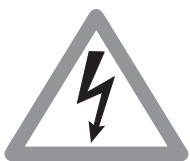
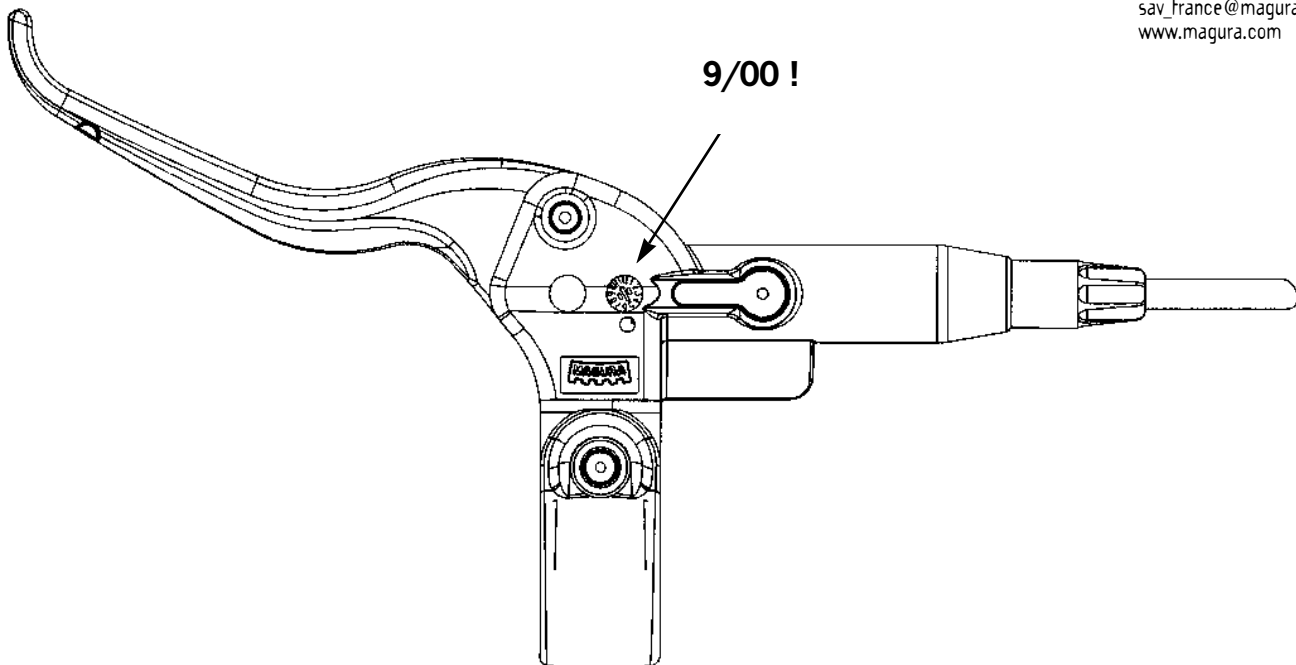

Clara-Bremsgriffe:

Achten Sie auf den Fertigungstempel auf der Unterseite des Bremsgriffs. Erst ab Fertigungsmonat **9/2000** sind Clara-Bremsgriffe mit der Stahlflex-Leitung kompatibel!

Clara brake levers:

Watch out for the production month indicated at the lower side of the brake lever. Only from **9/2000** onwards the Clara brake levers are compatible with the braided hose.

Poignées Clara

Vérifier le mois de production au dessous de la poignée. La poignée est compatible avec la durite tressée à partir de **9/2000!**

Join the Brake People!