

THIS BRIEF USER MANUAL CONTAINS IMPORTANT INFORMATION. PLEASE READ CAREFULLY AND STORE IN A SAFE PLACE.

This user manual is specific to your Specialized Roubaix or Ruby bicycle. It contains important safety, performance and technical information, which you should read before your first ride and keep for reference. You should also read the entire Specialized Bicycle Owner's Manual ("Owner's Manual"), because it has additional important general information and instructions which you should follow. If you do not have a copy of the Owner's Manual, you can download it at no cost at www.specialized.com, or obtain it from your nearest Authorized Specialized Retailer or Specialized Rider Care.

Additional safety, performance and service information for specific components such as suspension or pedals on your bicycle, or for accessories such as helmets or lights, may also be available. Make sure that your Authorized Specialized Retailer has given you all the manufacturers' literature that was included with your bicycle or accessories. If there is a difference between the instructions in this manual and the information provided by the component manufacturer, please refer to your Authorized Specialized Retailer.

When reading this user manual, you will note various important symbols and warnings, which are explained below:

	WARNING! The combination of this symbol and word indicates a potentially hazardous situation which, if not avoided, could result in serious injury or death. Many of the Warnings say "you may lose control and fall." Because any fall can result in serious injury or even death, we do not always repeat the warning of possible injury or death.
	CAUTION: The combination of the safety alert symbol and the word CAUTION indicates a potentially hazardous situation, which, if not avoided, may result in minor or moderate injury, or is an alert against unsafe practices. The word CAUTION used without the safety alert symbol indicates a situation which, if not avoided, could result in serious damage to the bicycle or the voiding of your warranty.
	INFO: This symbol alerts the reader to information which is particularly important.
	GREASE: This symbol means that high quality grease should be applied as illustrated.
	CARBON FRICTION PASTE: This symbol means that carbon friction paste should be applied as illustrated to increase friction.
	TORQUE: This symbol highlights the correct torque value for a specific bolt. In order to achieve the specified torque value, a quality torque wrench must be used.
	TECH TIP: Tech Tips are useful tips and tricks regarding installation and use.

INTENDED USE

The Specialized Roubaix and Ruby bicycles are intended and tested for road biking (condition 1) use only. For more information on intended use and structural weight limits for the frame and components, please refer to the Owner's Manual.

GENERAL NOTES ABOUT ASSEMBLY

This manual is not intended as a comprehensive assembly, use, service, repair or maintenance guide. Please see your Authorized Specialized Retailer for all service, repairs or maintenance. Your Authorized Specialized Retailer may also be able to refer you to classes, clinics or books on bicycle use, service, repair, and maintenance.

	WARNING! Due to the high degree of complexity of the Roubaix and Ruby, proper assembly requires a high degree of mechanical expertise, skill, training and specialty tools. Therefore, it is essential that the assembly, maintenance and troubleshooting be performed by an Authorized Specialized Retailer.
	WARNING! Many components on the Roubaix and Ruby, including, but not limited to, the handlebars and the stem, are proprietary to the Roubaix and Ruby. Only use originally supplied components and hardware at all times. Use of other components or hardware will compromise the integrity and strength of the assembly. Roubaix and Ruby specific components should only be used on the Roubaix and Ruby and not on other bicycles, even if they fit. Failure to follow this warning could result in serious injury or death.
	In order to successfully build the Roubaix and Ruby bicycles, it is very important to follow the order of operations as outlined in this manual. Modifying the order of assembly will result in a longer build process.

BOLT SIZE / TOOLS / TORQUE SPECS

	WARNING! Correct tightening force on fasteners (nuts, bolts, screws) on your bicycle is important for your safety. If too little force is applied, the fastener may not hold securely. If too much force is applied, the fastener can strip threads, stretch, deform or break. Either way, incorrect tightening force can result in component failure, which can cause you to lose control and fall. Where indicated, ensure that each bolt is torqued to specification. After your first ride, and consistently thereafter, recheck the tightness of each bolt to ensure secure attachment of the components. The following is a summary of torque specifications in this manual:
--	--

LOCATION	Allen Key Spec	Torque (in-lbf)	Torque (Nm)	LOCATION	Allen Key Spec	Torque (in-lbf)	Torque (Nm)
Stem @ steerer tube bolts	4mm	45	5.1	Headset adjustment locking screws	2.5mm	18	2.0
Stem @ handlebar bolts	4mm	45	5.1	Seat collar bolts	4mm	55	6.2
Stem top cap	4mm	18	2.0	Derailleur hanger bolt	4mm	40	4.5
Steerer tube collar pinch bolt	4mm	55	6.2	Water bottle / SWAT Road Box bolts	3mm	25	2.8
Steerer tube collar locating bolt	2.5mm	18	2.0				

	CAUTION: Ensure that all contact surfaces are clean and bolt threads are greased or have a threadlocking compound (refer to the instructions for each bolt) prior to installation.
--	---

The following tools are required for assembly of this product:

<ul style="list-style-type: none"> ■ 2, 2.5, 3, 4, 5mm Allen keys ■ 3, 4, 5mm socket Allen keys (3/8" socket) ■ Long 4mm Allen key bit for Roubaix/Ruby (S175300015) 	<ul style="list-style-type: none"> ■ Torque wrench (3/8" socket) ■ Cable and housing cutters 	<ul style="list-style-type: none"> ■ High-quality grease ■ Blue threadlocker (Loctite 242)
---	--	--

GENERAL NOTES ABOUT MAINTENANCE

The Specialized Roubaix and Ruby are high performance bicycles. All regular maintenance, troubleshooting, repair and parts replacement must be performed by an Authorized Specialized Retailer. For general information regarding maintenance of your bicycle, please refer to the Owner's Manual. In addition, routinely perform a mechanical safety check before each ride, as described in the Owner's Manual.

- Great care should be taken to not damage carbon fiber or composite material. Any damage may result in a loss of structural integrity, which may result in a catastrophic failure. This damage may or may not be visible in inspection. Before each ride, and after any crash, you should carefully inspect your bicycle for any fraying, gouging, scratches through the paint, chipping, bending, or any other signs of damage. Do not ride if your bicycle shows any of these signs. After any crash, and before you ride any further, take your bicycle to an Authorized Specialized Retailer for a complete inspection.
- While riding, listen for any creaks, as a creak can be a sign of a problem with one or more components. Periodically examine all surfaces in bright sunlight to check for any small hairline cracks or fatigue at stress points, such as welds, seams, holes, and points of contact with other parts. If you hear any creaks, see signs of excessive wear, discover any cracks, no matter how small, or any damage to the bicycle, immediately stop riding the bicycle and have it inspected by your Authorized Specialized Retailer.
- Lifespan and the type and frequency of maintenance depends on many factors, such as frequency and type of use, rider weight, riding conditions and/or impacts. Exposure to harsh elements, especially salty air (such as riding near the ocean or in the winter), can result in galvanic corrosion of components such as the crank spindle and bolts, which can accelerate wear and shorten the lifespan. Dirt can also accelerate wear of surfaces and bearings. The surfaces of the bicycle should be cleaned before each ride. The bicycle should also be maintained regularly by an Authorized Specialized Retailer, which means it should be cleaned, inspected for signs of corrosion and/or cracks and lubricated. If you notice any signs of corrosion or cracking on the frame or any component, the affected item must be replaced.
- Regularly clean and lubricate the drivetrain according to the drivetrain manufacturer's instructions.
- Do **not** use a high pressure water spray directly on the bearings. Even water from a garden hose can penetrate bearing seals and crank interfaces, which can result in increased bearing and crank wear, which can affect the normal function of the bearings. Use a clean, damp cloth and bicycle cleaning agents for cleaning.
- Do **not** expose the bicycle to prolonged direct sunlight or excessive heat, such as inside a car parked in the sun or near a heat source such as a radiator.

WARNING! Failure to follow the instructions in this section may result in damage to the components on your bicycle and will void your warranty, but, most importantly, may result in serious personal injury or death. If your bicycle exhibits any signs of damage, do not use it and immediately bring it to your Authorized Specialized Retailer for inspection.

WARRANTY

Please refer to the written warranty provisions provided with your bicycle, or visit www.specialized.com. A copy is also available at your Authorized Specialized Retailer.

INSTALLING THE SEATPOST

The Roubaix and Ruby frames are designed to accept 27.2mm seatposts and are equipped with an integrated seat collar located below the top tube. Only use the specified collar to clamp the seatpost.

- **Fig.3:** Place the rubber seal on the seatpost.
- **Fig.3:** Insert the seatpost into the seat tube.
- **Fig.3:** Gradually tighten the two bolts until lightly snug and the gaps are even. Torque the bolts to 55 in-lbf (6.2 Nm).
- Verify the saddle height and position, adjust if necessary, then re-torque the collar.
- Slide the rubber seal down over the seat tube, with the logo facing the back of the bike.

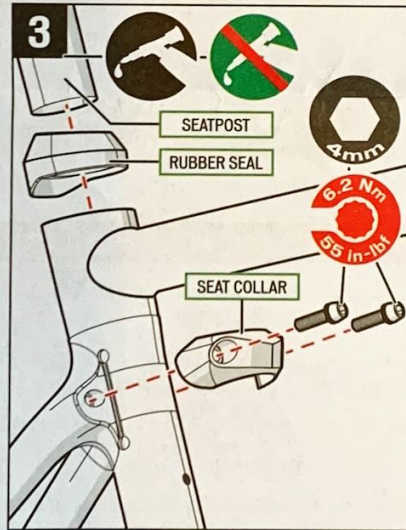

To prevent damage to the frame and/or seatpost, it is important to have a minimum amount of seatpost insertion in the seat tube. This minimum insertion must meet the following requirements:

- **Fig.4:** The seatpost must be inserted into the frame deep enough so the minimum insertion/maximum extension (min/max) mark on the seatpost is not visible.
- **Fig.4:** The seatpost must also be inserted into the seat tube deep enough to be visible through the sight hole.
- If the seatpost and frame minimum insertion requirements differ from each other, always use the longer minimum insertion. For example, if the frame sight hole is 130mm from the collar, but the seatpost requires 100mm, then 130mm is the minimum insertion required.

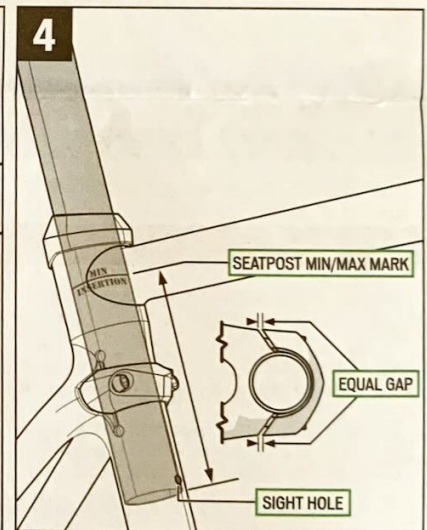

If the seatpost is at the min/max mark and the seatpost is not visible through the sight hole, the seatpost is not inserted deeply enough into the seat tube and should be lowered until it can be seen through the sight hole. This may result in the saddle being too low. If so, the seatpost must be replaced with a longer seatpost.

WARNING! Failure to follow the seatpost and frame minimum insertion requirements may result in damage to the frame and/or seatpost, which could cause you to lose control and fall.

If the seatpost is cut short, the min/max mark on the seatpost may no longer be accurate. Before cutting the seatpost, note the min/max depth required by the seatpost manufacturer.

WARNING! For general instructions regarding the installation of the seatpost, refer to the appropriate section in the Owner's Manual. Riding with an improperly tightened seatpost can allow the saddle to turn or move and cause you to lose control and fall.

WARNING! Inspect the seatpost and seat tube to ensure that there are no burrs or sharp edges. Remove any burrs or sharp edges using fine grit sandpaper.

CAUTION: When tightening the seat collar, it's important to make sure the gap on both sides between the frame and the collar are the same (fig.4).

Fig.3: Do not apply grease to the contact surfaces between the seatpost and the seat tube. Grease reduces the friction, which is critical to proper seatpost grip. Specialized recommends the application of carbon assembly compound (fiber paste), which can increase friction between carbon surfaces. Please visit your Specialized Authorized Retailer for additional information.

INSTALLING THE BOTTOM BRACKET

The Roubaix and Ruby frames use either a carbon 42mm x 68mm OSBB bottom bracket shell or a 68mm standard BSA threaded design.



CAUTION: Do not face or ream the bottom bracket shell! This can prevent proper installation of the crank. Your Specialized frame does not require any bottom bracket shell pre-installation preparation, as all surfaces have been precisely machined to specific tolerances at the factory for proper interface with OSBB/BB30 compatible crankset. Please refer to the manufacturer instructions for crank and bottom bracket installation.

INTERNAL CABLE ROUTING

The Roubaix and Ruby frames are equipped with internal routing entry ports for front and rear derailleur housings or electronic shifting wires, as well as disc brake housings.

MECHANICAL SHIFTING:

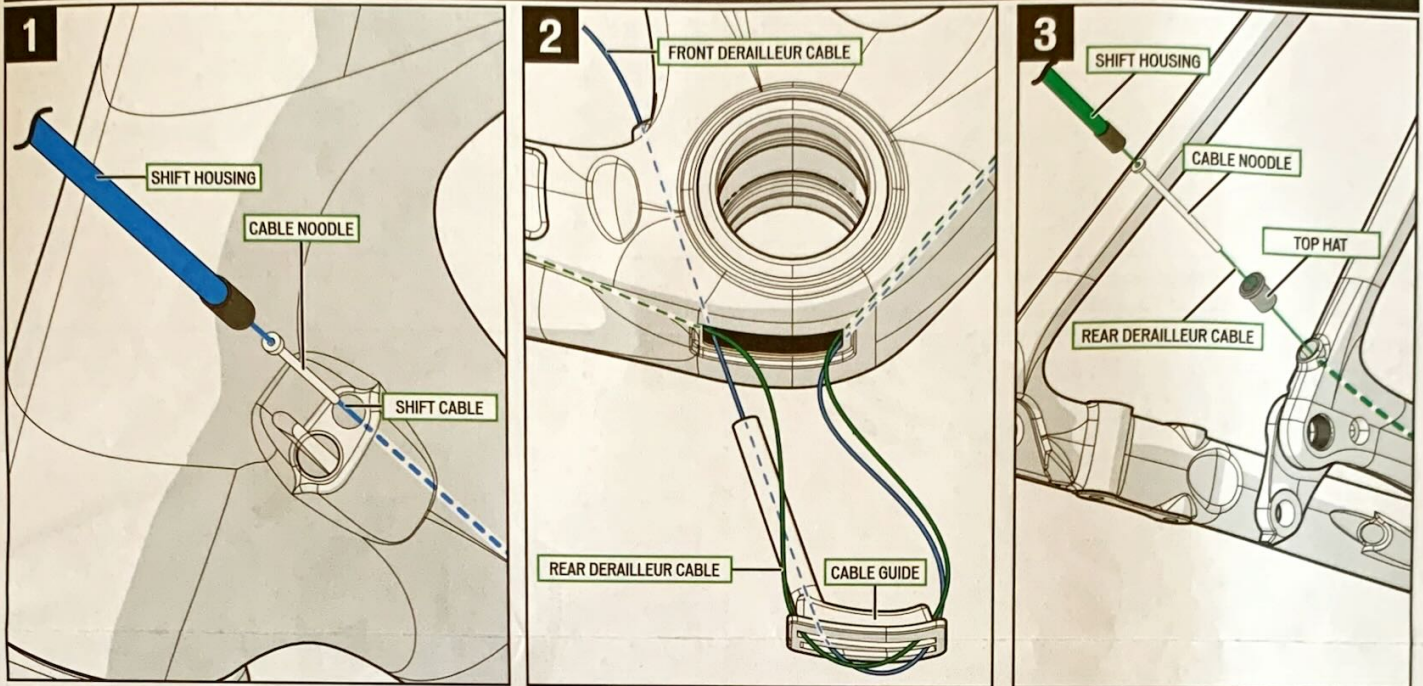

- Fig.1: Before installing the shifter cable housings with 4mm ferrules, install a flanged cable noodle into the drive-side and non-drive-side entry ports.
- Fig.2: Guide the cables out the exit port at the bottom bracket. Make sure they're crossing themselves only once.
- Fig.2: Route the rear shift cable through the bottom bracket cable guide, then back into the chainstay until it exits at the drive-side rear dropout (fig.3).
- Fig.2: Route the front shift cable through the bottom bracket cable guide and up the guide extension, then through the frame until it exits above the bottom bracket.
- Fig.3: Install a Top Hat over the cable and into the dropout, followed by a flanged cable noodle and a section of rear cable housing with 4mm ferrule.

ELECTRONIC SHIFTING:

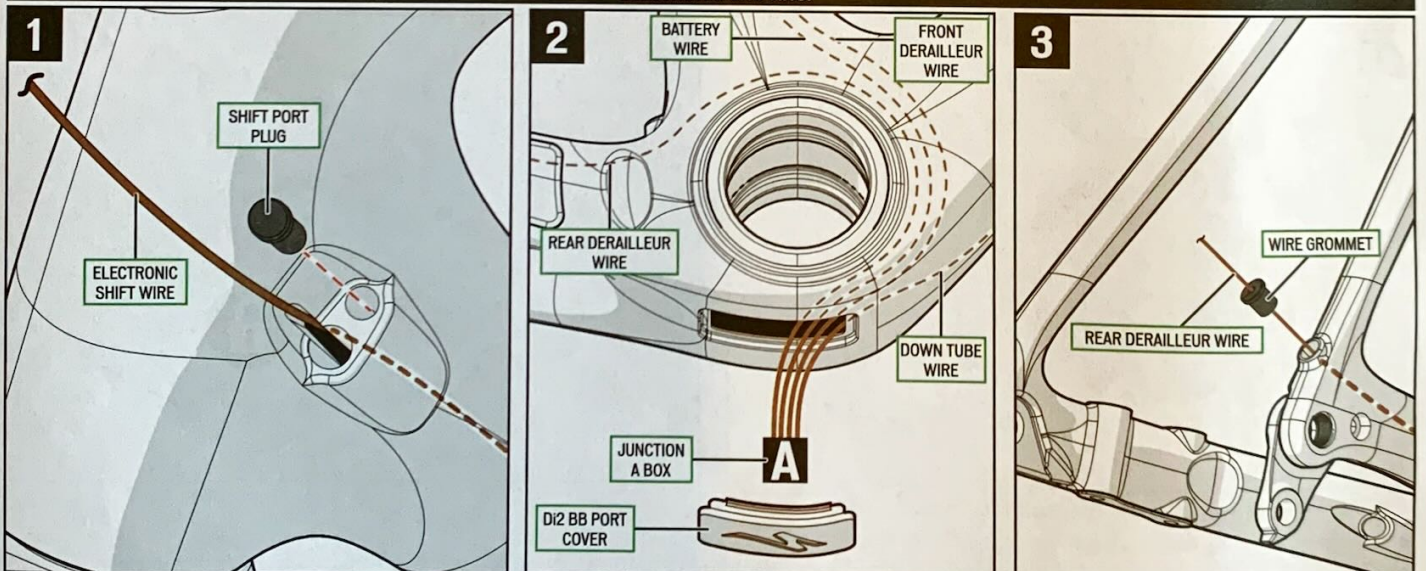

- Fig.1: Insert the wire into the down tube on the non-drive-side, next to the rear brake housing, until it exits at the bottom bracket exit port. Insert a Di2 plug in the empty shift port hole.
- Follow the manufacturer instructions for routing the front and rear derailleur wires, as well as the battery wire.
- Fig.2: Guide the down tube, seat tube, front and rear derailleur wires out the bottom bracket exit port, then plug them into the Junction A box. Place the Junction A box inside the down tube, then install the bottom bracket port plug into the frame.

■ Fig.3: Place a Di2 grommet over the rear derailleur wire exiting the dropout and insert the grommet in the dropout exit port.



Di2 wiring must be routed through downtube entry port BEFORE the rear brake housing is installed.

DISC BRAKE:

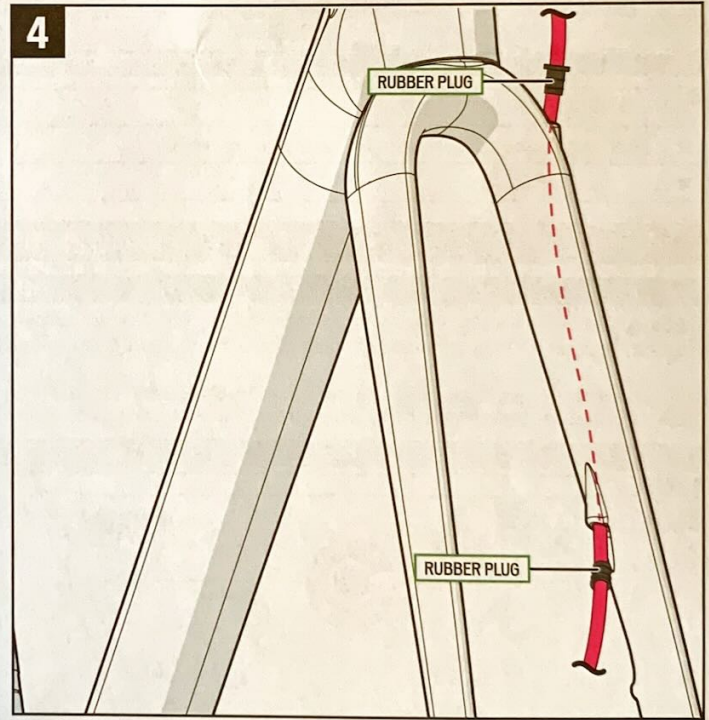
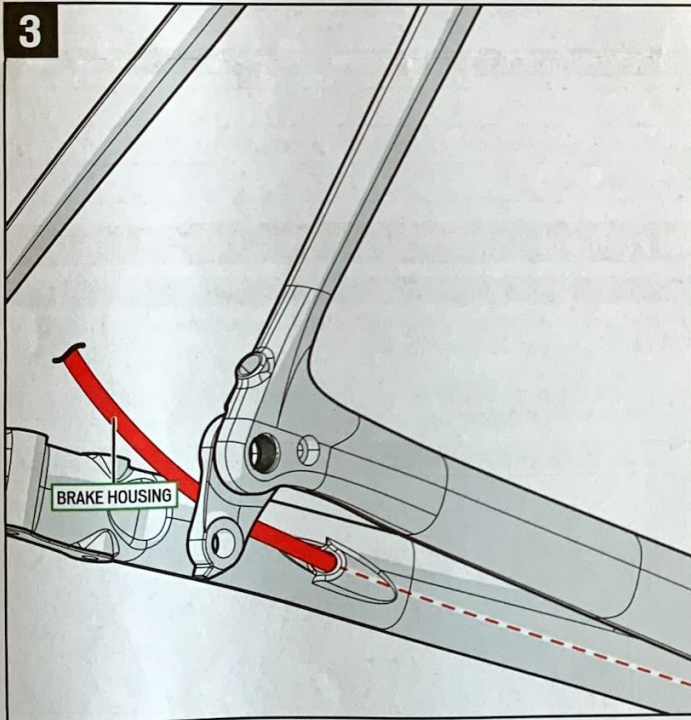
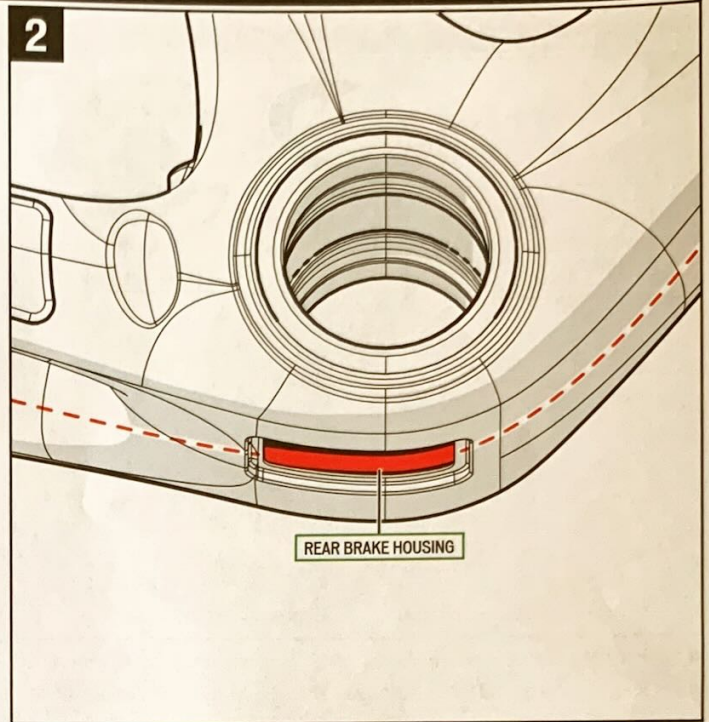
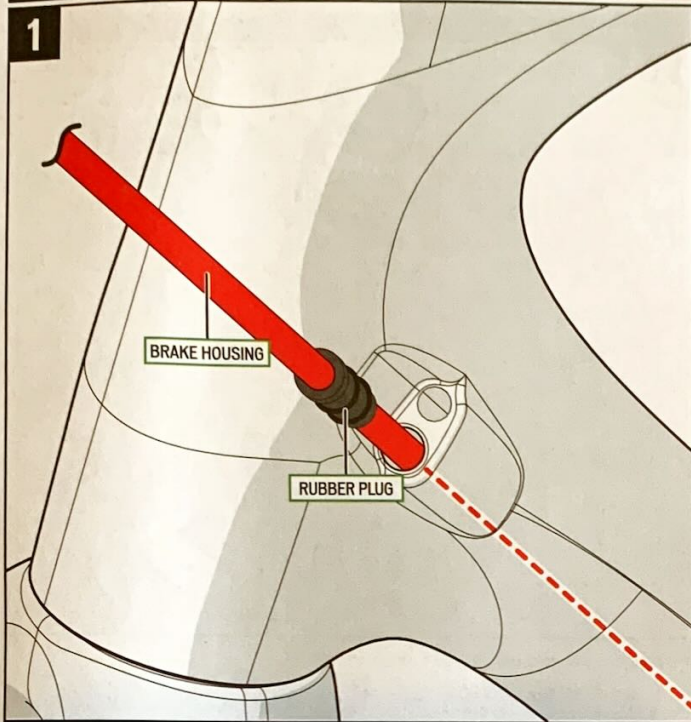

■ Fig.1: Run the housing into the frame either from the down tube to the chainstay or vice versa, depending on the model of brake being installed. Install the brakes according to the brake manufacturer's instructions. Install the supplied rubber plugs on the brake housing and into the entry/exit ports.

■ Fig.2: Route the rear brake housing under the bottom bracket shell.

■ Fig.3: Once the brake housing exits the chainstay port, install a rubber plug on the brake housing and into the exit port.

■ Fig.4: Run the housing into the fork either from the top or the bottom, depending on the model of brake being installed. Install the fork and cartridge system according to the steps outlined on pages 5-6, then install the brakes according to the brake manufacturer's instructions.

INSTALLING THE FORK AND FUTURE SHOCK CARTRIDGE

A video for the Future Shock cartridge is available by going to <http://servicevideos.specialized.com/video/180190215>, or scanning the QR Code.

The Specialized Future Shock cartridge, fork and headset are designed as an integrated unit and are only intended for use and compatible with Specialized Roubaix and Ruby carbon frames. Only use the specified parts when assembling the front end of a Roubaix or Ruby bicycle.



! WARNING! The fork steerer tube is pre-cut to the size of the frame. Do not cut the fork, or use a fork that is too short. Ensure that the size written on the fork matches the size of the frame.

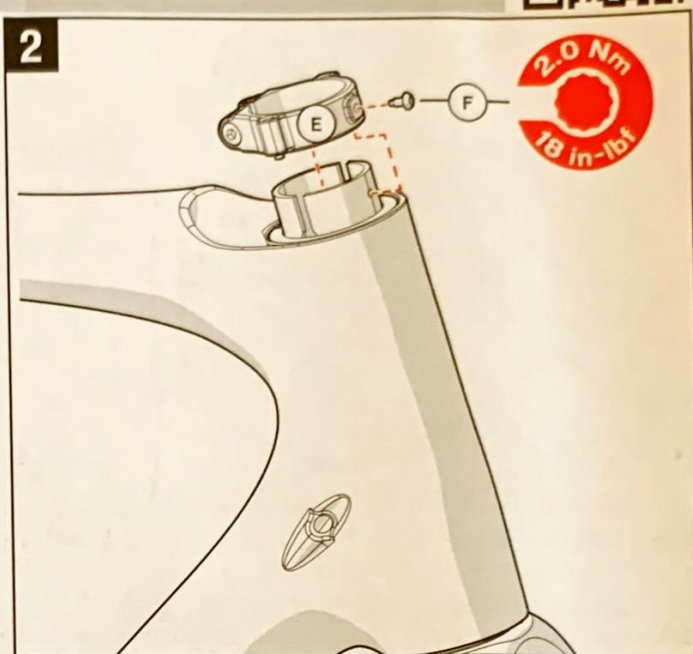
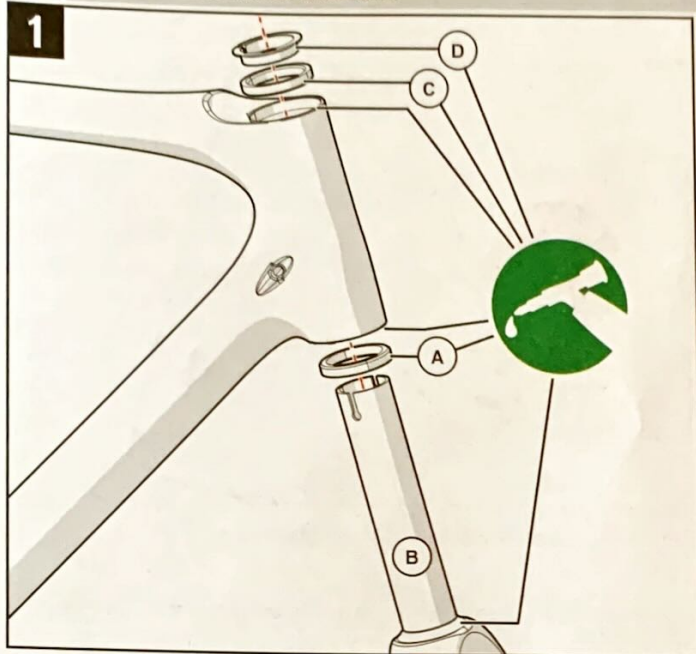

■ Fig.1: Grease, then install the lower bearing (A) on the fork (B). Insert the fork into the head tube, then grease and install the upper bearing (C) and compression ring (D) on the steerer tube.

! CAUTION: Ensure that the compression ring slot is facing toward the front or rear of the bike. Do not place the slot near the headset preload bolts.

■ Fig.2: Grease, then install the steerer tube collar bolt, washer and barrel (fig.3). Install the steerer tube collar (E) then install the locator bolt (F) in the collar, to lock the collar on the steerer tube. Torque the bolt to 18 in-lbf (2.0 Nm).

! WARNING! To ensure that the collar and fork locator bolt holes are aligned with each other, place a 2mm Allen key through the holes before installing and tightening the locator bolt. Ensure that the headset adjustment set screws are backed out before installing the collar.

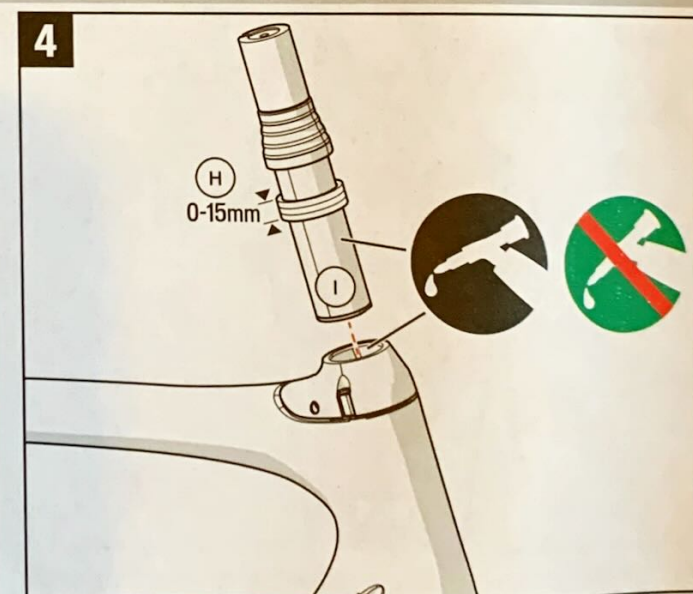
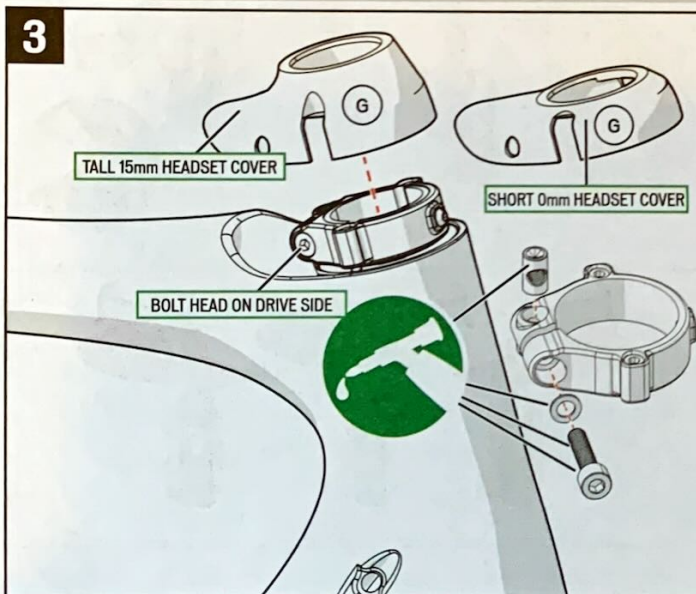

■ Fig.3: Choose the tall or short stack headset cover (G), then place it over the steerer tube collar. Please note that the published stack/reach geometry is based off the short 0mm cover.

■ Fig.4: Install 0-15mm of steerer tube spacers (H) on the cartridge assembly (I), then insert the cartridge assembly into the steerer tube.

! WARNING! To ensure proper insertion of the Future Shock cartridge in the steerer tube, do not install more than 15mm of spacers over the 0mm or 15mm headset covers. Ensure there is no grease between the steerer tube and the cartridge. Grease can cause the cartridge to slip, which can result in a loss of control.

💡 Specialized recommends the application of carbon assembly compound (or carbon paste) between the cartridge and steerer tube to increase friction. See your Authorized Specialized Retailer if you have any questions.

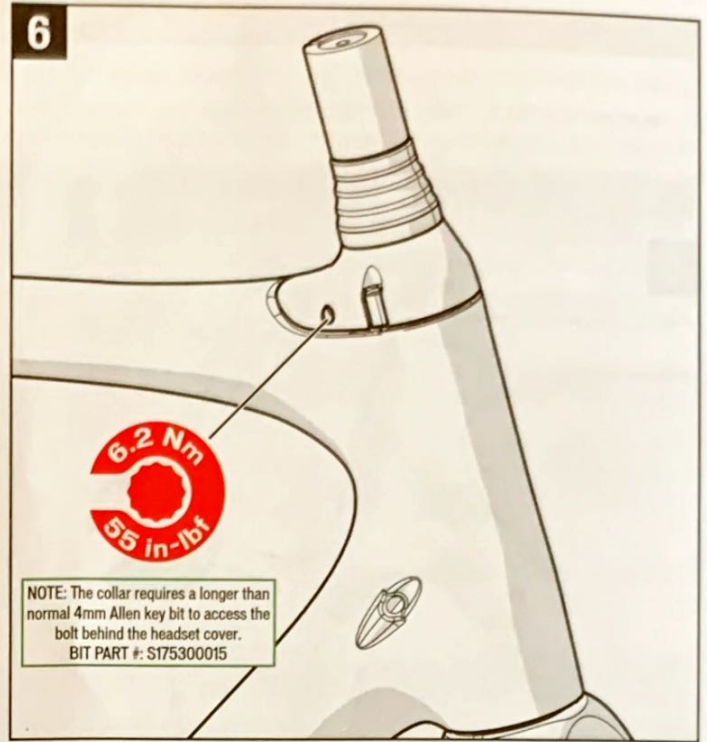
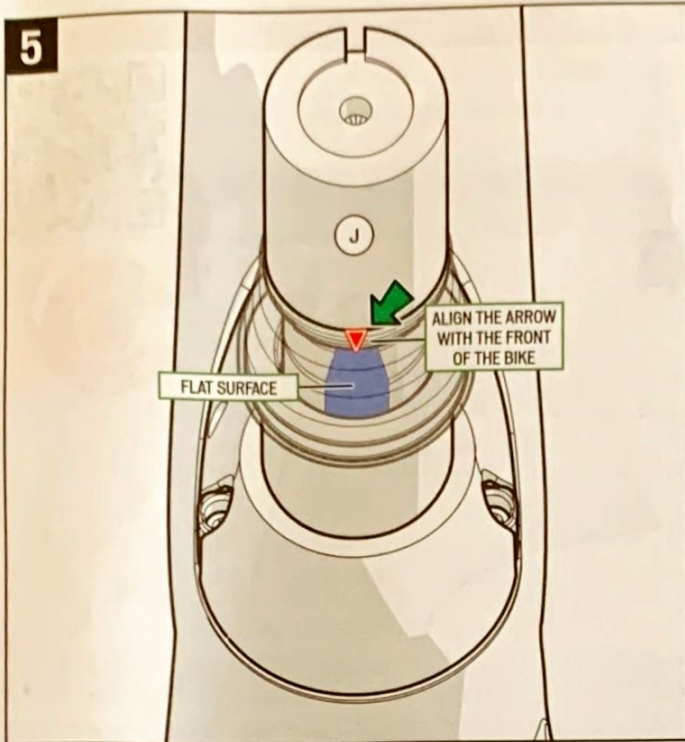

- Fig.5: Align the cartridge so that one of the three flat surfaces faces toward the front of the bike. The stem shim (J) must also align toward the back of the bike.
- Fig.6: Torque the steerer tube collar to 55 in-lbf (6.2 Nm).

WARNING! When the cartridge is installed, ensure that the steerer tube collar bolt is greased and torqued to specification. Do not tighten the collar without the cartridge installed. An improperly installed and/or tightened collar may result cause you to lose control and fall.

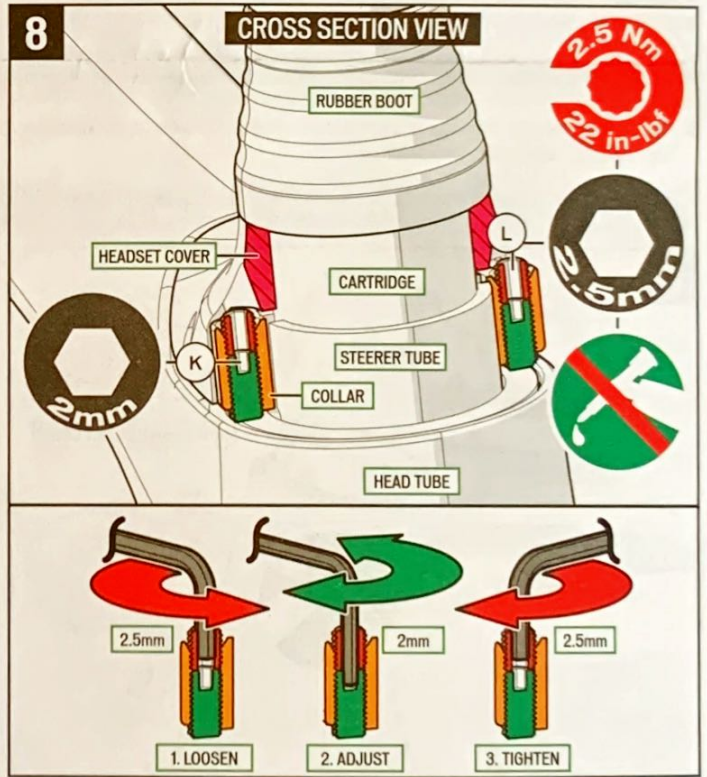
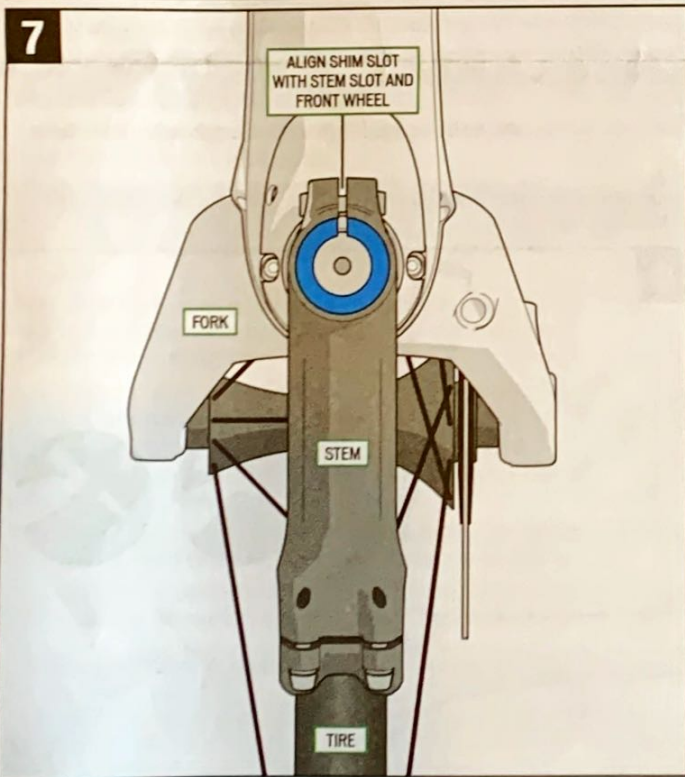

- Fig.7: Install the stem on the cartridge, then align the stem with the shim slot and the front wheel. Torque the stem according to the manufacturer specifications. Install the brakes (page 4).
- Install the top cap, then torque to 18 in-lbf (2.0 Nm).
- Fig.8: Adjust the two preload screws (K) using a 2mm Allen key, until they both contact the compression ring. Gradually and evenly alternate between the two preload screws while engaging the front brake and rocking the bike back-and-forth until any movement/looseness is eliminated and the headset rotates freely.

Lightbulb icon: To access the preload screw (lower), the 2mm Allen key goes through the upper locking screw. The upper locking screw is tightened using a 2.5mm Allen key.

- Fig.8: Torque the upper locking screws (L, 22 in-lbf (2.5 Nm)) down onto the preload screws (K) below to lock the preload screws in place. **DO NOT GREASE THE LOCKING SCREWS!**

ADJUSTING THE STACK HEIGHT

- Remove the top cap and stem.
- Loosen the collar pinch bolt and back out the set screws.
- Remove the cartridge from the steerer tube. **DO NOT REMOVE THE BOOT!** The boot is very tight and difficult to get back on, and exposes the internals to contamination.
- Refer to Fig.3-8, pages 5-6 for installation steps on adjusting the stack height.

CHANGING THE SPRING RATE

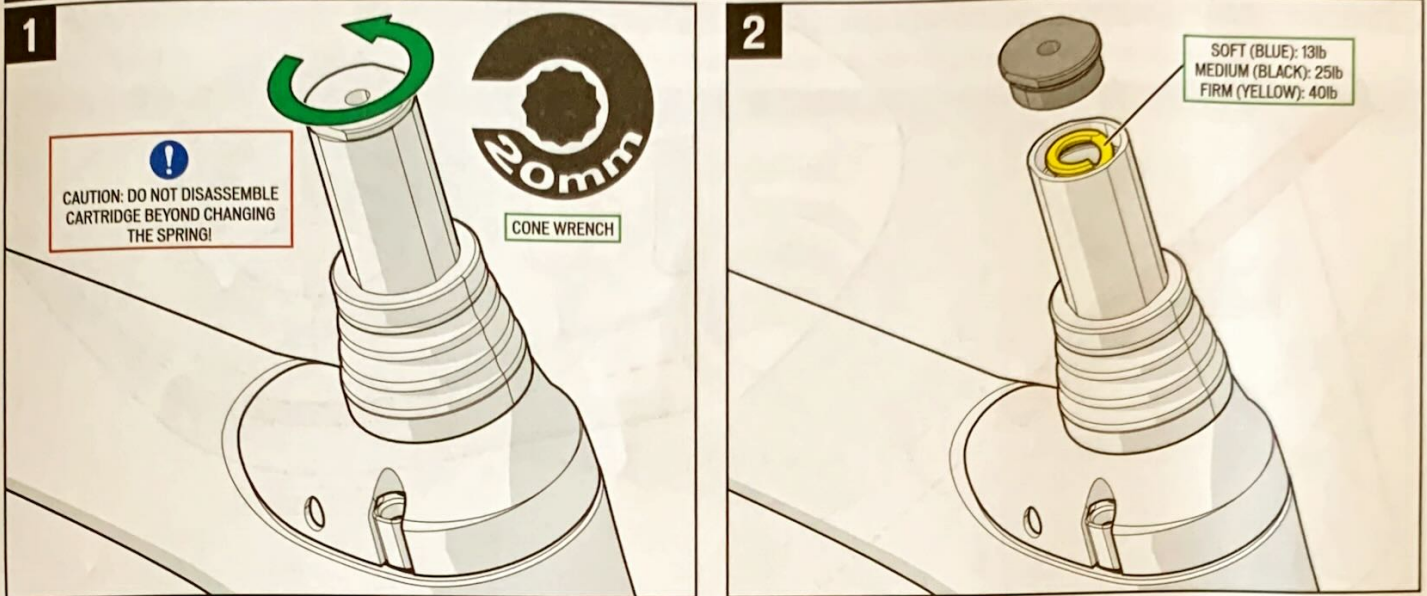

- Fig.1: To replace the spring with a different spring rate, remove the stem and shim, then unscrew the cartridge top cover using a 20mm cone wrench.
- Fig.2: Lift the spring out of the cartridge cavity, install the desired spring then reinstall the top cover. Tighten so the cover is snug.

! **CAUTION:** When loosening the top cover to change the spring, leave the cartridge in the fork, clamped by the collar. Do not place the cartridge in a table vise!

HEADSET/STACK HEIGHT ADJUSTMENT CHECKLIST

■ USE A TORQUE WRENCH!	■ Is the headset adjusted?
■ Is the arrow on the cartridge boot aligned toward the front of the bike?	■ Are the set screws applying even pressure, with the lock screws tightened down?
■ Is the collar pinch bolt tight?	■ Are the stem bolts tight?

INSTALLING THE SWAT ROAD BOX

INTENDED USE

The Specialized SWAT Road Box is intended for use and compatible with Specialized carbon road frames with a 3rd bottle boss on the down tube and seat tube, below the standard water bottle bosses. It's designed to carry a spare tube (max 18-25c), 16g CO2 cartridge, CO2 head, tire lever, EMT Road Tool, valve extender and spare cash.

! **WARNING!** Specialized recommends the installation of the SWAT Road Box be performed by an Authorized Specialized Retailer. Do not install the SWAT Road Box on an incompatible frame (even if it fits) or try to mount the SWAT Road Box on a frame with a method other than specified in this manual.

INSTALLATION AND ASSEMBLY

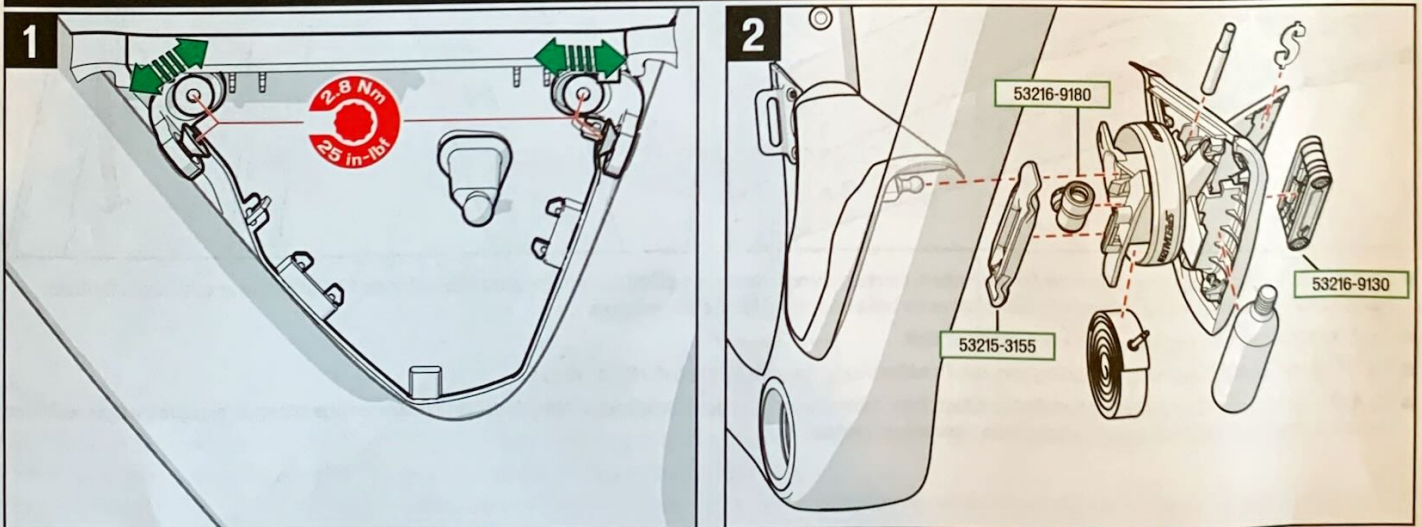

- Fig.1: Bolt the two the brackets to the frame first, but only hand tight.
- Fig.1: Bolt the drive-side box panel to the brackets, adjust the position to fit the frame size, then torque the four bolts to 25 in-lbf (2.8 Nm).
- Fig.2: Install the box hardware (tube, tire lever, 16g CO2 cartridge, CO2 head, valve extender, EMT tool). See steps below.

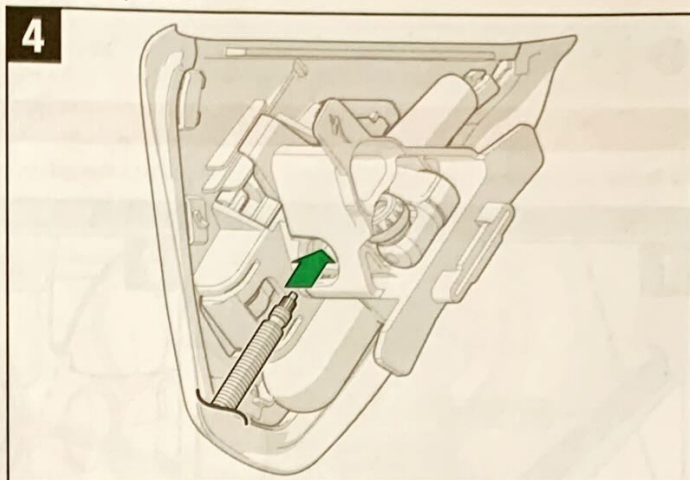
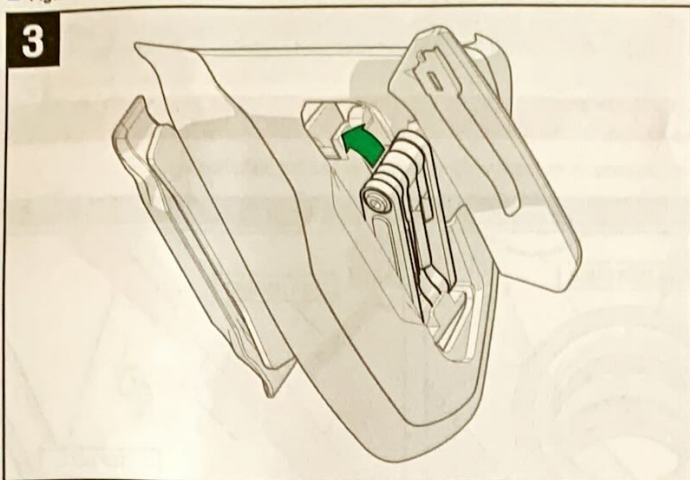

- Fig.3: Install the EMT tool into the receptacle beneath the door.
- Fig.4: Make sure there's no air at all in the tube, then insert the valve into the valve hole.

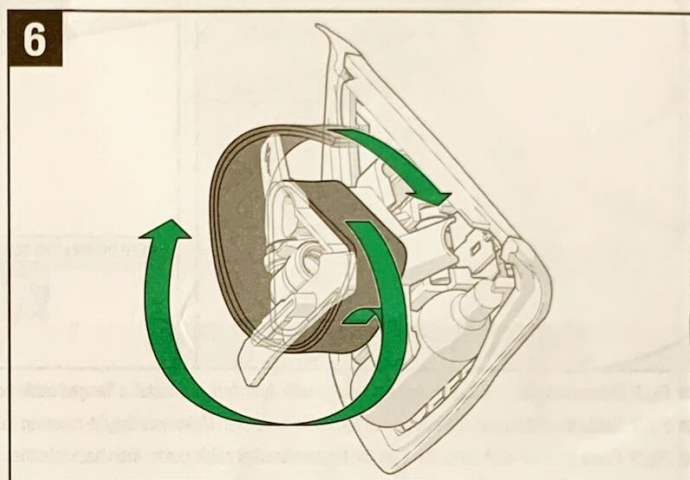
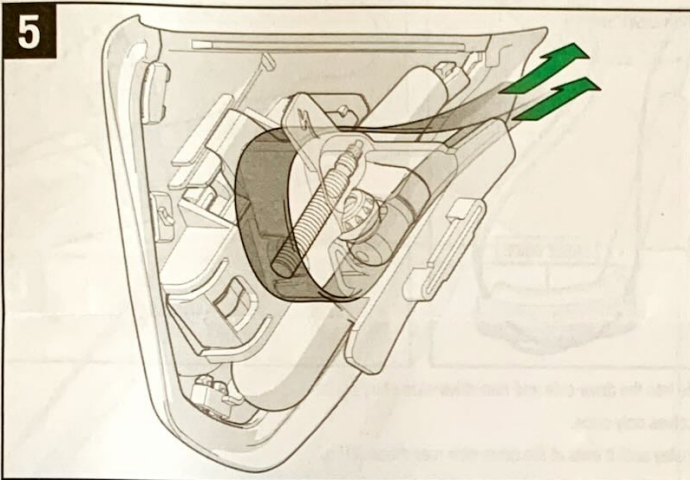

- Fig.5: With the valve in the hole, wrap the tube around the hardware core.
- Fig.6: Pinch the tube at the opposite end of the core, then wrap the tube down and around the core. The location of the pinch and tube wrapping direction provide the most clearance between the tube and the box when connecting the two panels.

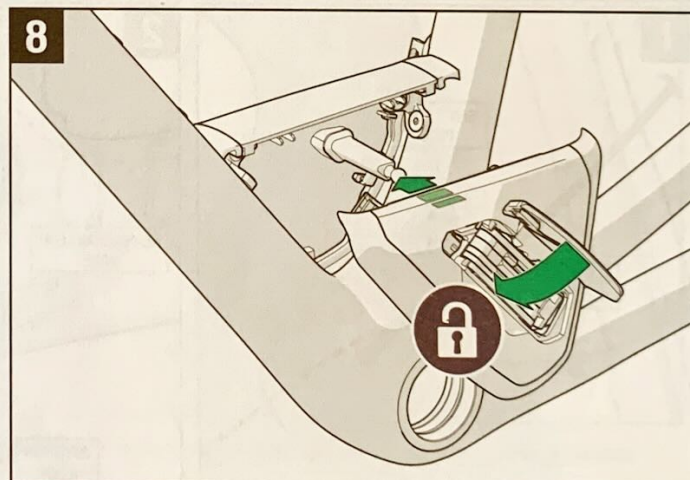
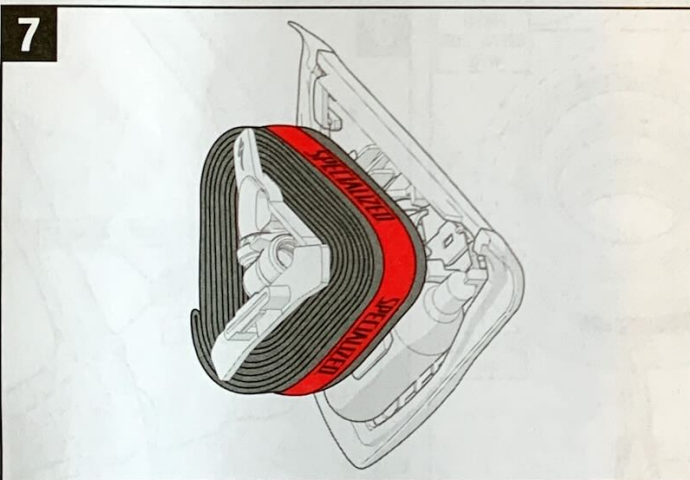

- Fig.7: Wrap the tube holder band around the tube to hold it in place.
- Fig.8: Install the non-drive-side panel with all the hardware onto the frame, then close the door to lock the panel in place.

WARNING! Ensure all the parts are securely installed in the SWAT Road Box, the bolts are properly torqued and the removable panel is properly installed, with the door fully closed (locked). Do not ride with an unlocked panel. A loose panel can fall off and interfere with the safe operation of the bicycle.