

The winning blue Collection 2014



1994



1999

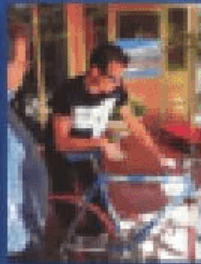

2001



2012



2013

Like Henry Ford,
I will sell you a bike in any colour
you like ... As long as it's blue!

Alfredo Gios



GIOS

GIOS - the winning blue collection 2014

Modern bikes

Aero Lite	4
Tornado	5
Gress	6
Endurance	8
Aero Master	9
Stilo	10
Ampio	12
Pure Drop	13
Mignon	14
Easy Drop	16

Classic bikes

Titanio	18
A-90 Aegis	19
Compact Pro	20
Steel Master	21
Vintage	22
Antico	23
Spazio	24

Clothing	26
-----------------------	----

Accessoires	28
--------------------------	----

GIOS cycle sponsoring	30
------------------------------------	----

Join the winning blue	31
------------------------------------	----

GIOS

GIOS - the beauty of italian design

For many years the GIOS company has been producing racing frames and bicycles for professional use at very high levels.

Our "corsa" frames are from a victorious school of riders and for decades they have been used by the top professional teams in all the most important races around the world.



Our products are at the forefront of technology and innovation, built with the finest materials available to give exceptional finishing and personalization that assures quality in every detail.

Whether in competition or pleasure GIOS can deliver the ride of Champions and the ride of a lifetime.

Modern bikes

GIOS AERO LITE - incredibly aerodynamic



Complete bike image
custom made example



AERO LITE

	48	50	52	54	56	58
A(C-T)	480	500	520	540	560	580
B	515	535	545	555	575	595
C	74°	73.5°	73.5°	73.5°	73°	73°
D	48	48	48	48	48	48
E	408	408	408	408	408	408
F	125	140	150	160	170	180

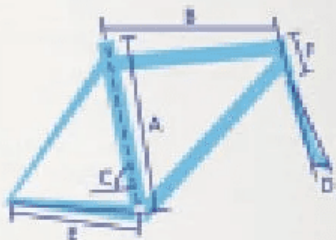

Frame and fork set

GIOS TORNADO - lighter, stiffer, more comfortable

Modern bikes



Complete bike image
custom made example

TORNADO

	50	53	55	58	60
A(C-T)	500	530	555	580	605
B	513	533	554	574	595
C	74°	73.7°	73.3°	72.9°	72.5°
D	45	45	45	45	45
E	412	412	412	412	412
F	123	147.5	174	198	224

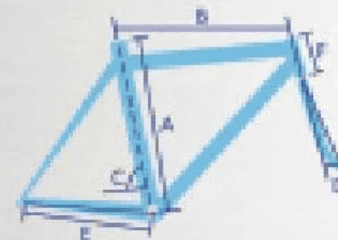

GIOS GRESS - carbon in its best shape



Velo motion Alles was dich schneller macht

Velomotion 09/2013:
"Absolutely rigid"



Complete bike image
custom made example

GRESS

	48	50	52	54	56	58	60
A(C-T)	490	510	520	540	560	580	600
B	510	525	535	545	560	575	590
C	74.5°	74.5°	74°	73.5°	73.5°	73°	72.5°
D	45	45	45	45	45	45	45
E	408	408	408	408	408	408	408
F	120	130	140	155	170	190	210

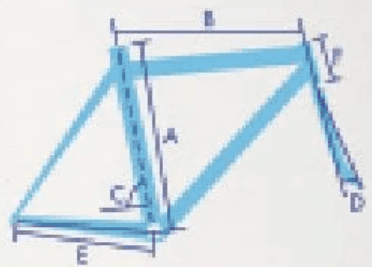

Frame and fork set



GIOS ENDURANCE - expert on long distances



Procycling

RennRad!

TOUR

Pro cycling 11/2012, S.

Rennrad 06/2013:

Lang: "The bike inspired me and, most of all: It convinced me"

"Price-performance ratio 8/10"

Tour 01/2013: "Most comfortable frame, 2,0"

ENDURANCE

	46	49	52	55	58
A(C-T)	490	500	520	540	560
B	520	530	550	560	560
C	74.0"	74.5"	74.9"	75.5"	76.0"
D	45	45	45	45	45
E	408	412	412	412	414
F	120	130	150	170	195

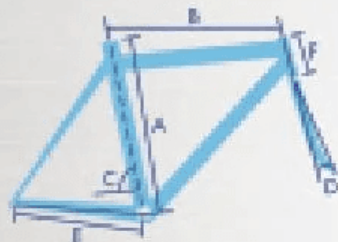

Frame and fork set

GIOS AERO MASTER - the ultimate time trial machine

Modern bikes



Frame and fork set



Complete bike image
custom made example

AERO MASTER

	46	48	50	52
A/(C-C)	460	480	500	520
B	495	515	535	555
C	78°	78°	78°	78°
D	43	43	43	43
E	385	385	385	385
F	83	104	124	144

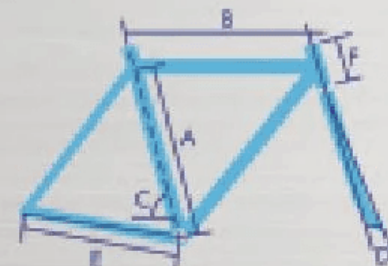



GIOS STILO - choice of messengers

GIOS STILO available in black, GIOS blue
Both colours available as flatbar version

STILO

	48	52	55	58
A(C-T)	490	520	550	580
B	515	530	545	570
C	73.5°	73.5°	73.5°	73.5°
D	43	43	43	43
E	405	405	405	405
F	55	100	115	145

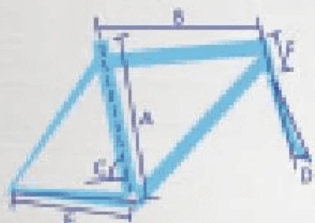



GIOS AMPIO - What GIOS is all about



AMPIO

	47	51	54	57
A(C-T)	470	510	540	570
B	530	540	555	570
C	74.5°	74°	73.5°	73°
D	45	45	45	45
E	410	410	410	410
F	90	100	107	130

The diagram shows a bicycle frame with various dimensions labeled: A (top tube length), B (chainstay length), C (head tube angle), D (seat tube angle), E (wheelbase), and F (front overhang).



GIOS PURE DROP - pretty in mud

Modern bikes



PURE DROP

	46	48	52	55
A(C-T)	460	490	520	550
B	515	530	545	560
C	75°	74°	73°	72°
D	50	50	50	50
E	430	450	470	490
F	100	100	110	120

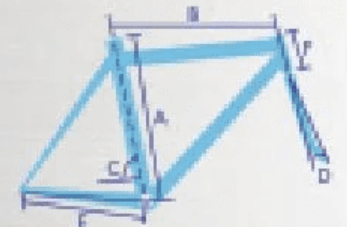

GIOS MIGNON - with certain flair and cult status

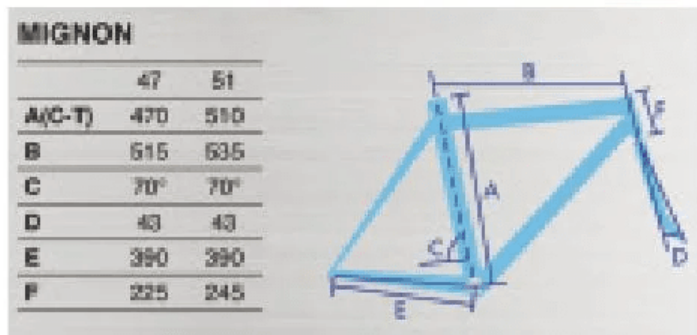



GIOS EASY DROP - for the next generation



EASY DROP

	38
A(C-T)	380
B	435
C	74°
D	45
E	360
F	80

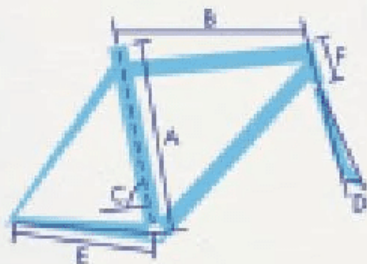



GIOS TITANIO - sophisticated and timeless



RoadBIKE

Roadbike 08/2013: "Stiffer than all carbon framesets in the test"



Complete bike image
custom made example

TITANIO

	48	50	52	54	56	58
A(C-C)	480	500	520	540	560	580
B	515	525	535	545	555	565
C	74.5"	74"	73.5"	73"	73"	72.75"
D	45	45	45	45	45	45
E	405	407	407	407	407	408
F	100	117	135	150	170	190

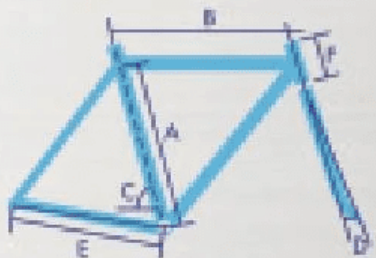

Frame and fork set

GIOS A-90 AEGIS - epitome of traditional alu-frames

Classic bikes



Frame and fork set



Complete bike image
custom made example

A-90 AEGIS

	48	50	52	54	56	58
A(C-C)	480	500	520	540	560	580
B	515	525	535	545	555	565
C	74.5"	74"	73.5"	73"	73"	72.75"
D	45	45	45	45	45	45
E	405	407	407	407	407	405
F	100	117	135	150	170	190

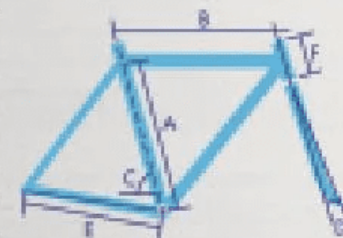

Classic bikes

GIOS COMPACT PRO - the modern classic



RoadBIKE

Roadbike 12/2011: GUT

COMPACT PRO

	48	50	52	54	56	58
A/C-C)	490	500	520	540	560	580
B)	515	525	535	545	555	565
C	74.5°	74°	73.5°	73°	73°	72.5°
D)	45	45	45	45	45	45
E	403	404	405	406	406	407
F	85	96	114	132	150	168

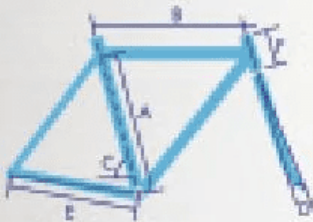

GIOS STEEL MASTER - 65 years of experience

Classic bikes



TOUR

Tour 08/2013: "2,1 - best frameset"

STEEL MASTER

	48	50	52	54	56	58
A(C-D)	480	500	520	540	560	580
B	515	525	535	545	555	565
C	74,5"	74"	73,5"	73"	72"	71,5"
D	45	45	45	45	45	45
E	403	404	405	406	407	407
F	85	88	114	132	150	169

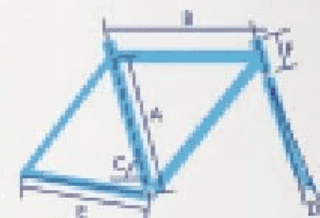



GIOS VINTAGE - for all retro fans

GIOS VINTAGE available in Italian, GIOS blue, Pearlwhite

VINTAGE						
	48	50	52	54	56	58
A(D-C)	490	500	509	540	590	640
B	515	525	535	545	555	565
C	74.5°	74°	73.5°	73°	73°	72.5°
D	45	45	45	45	45	45
E	404	404	404	404	405	405
F	95	105	125	140	160	180

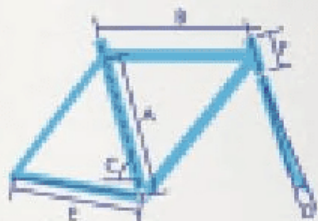

GIOS ANTICO - fits everywhere

Classic bikes



ANTICO

	48	51
A(C-T)	480	510
B	615	635
C	70°	70°
D	43	43
E	390	390
F	225	245

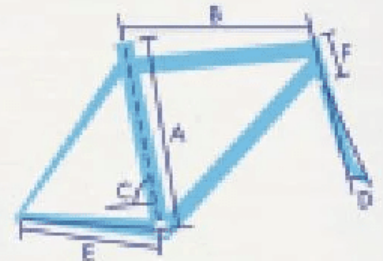

GIOS SPAZIO - randonneur with great stamina



SPAZIO

	49	52	55	58
A/C-TI	450	520	550	590
B	520	540	560	590
C	73°	73°	73°	73°
D	90	90	90	90
E	430	430	430	430
F	90	100	150	170

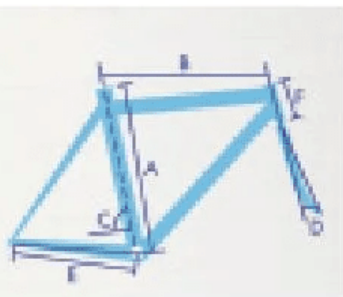



Clothing



GIOS Jersey
(XS-XXL)



GIOS Racing Cap



GIOS Junior Jersey
(XXXS-5)



GIOS BIB Short
(XXXS-3L)



GIOS Arm warmer (M-L)



GIOS Junior Glove
(XXXS-S)



GIOS Glove
(XS-XL)



Accessories



GIOS Selle Italia
Q-BIK Saddle



GB



GIOS Selle Italia
SL Saddle



WH



GIOS Saddle



BK



GIOS Bar tape



WH Logo BK

WH Logo GB



BK Logo WH

GB Logo WH

GIOS Bottle cage



SL

BK

GIOS
Bottle



GIOS Toolbottle
Gr.: S, L





GIOS Saddle bag



GIOS Mini pump

GIOS Thread Stem 1"



GIOS Stem



GIOS Carbon pacer



GIOS Touch up paint



GIOS Seat clamp

GIOS Fork CR-MO 1"



GIOS Handle bar

GIOS cycle sponsoring

- GIOS TEST-Team founded in 2013
- 70 riders from all categories
- Participation in international events
- Supported by various sponsors and partners





Join the winning blue!

For further information about GIOS and all test reviews look at www.gios.eu

"The winning blue"
- on Facebook

TOUR

RennRad

RoadBIKE

ProCycling

Velo motion

die neue Welt der Radfahrer





1934



1935



1975



1976



1981



1985

1936



1980



Alfredo Gios

For Europe: GIOS Deutschland GmbH Headquarter

Herzogstr. 40 • D - 40625 Düsseldorf

Tel.: +49 211 942 192 57 • Fax: +49 211 938 98 446

gios@gios.eu • www.gios.eu