

Campagnolo

1933 - 2008 ANNIVERSARY EDITION - 75 YEARS OF PASSION



2008 RANGE CATALOGUE

ENGLISH



04	History
12	Technology
24	Record™
34	Chorus™
42	Centaur™
50	Veloce™
58	Mirage™
66	Xenon™
72	Record™ Pista™
74	TimeTrial™
76	Triple
80	Low profile wheels
88	Medium profile wheels
102	High profile wheels
108	Technical Specifications Groupsets
118	Technical Specifications Wheels
122	How we work
124	Campagnolo® World
126	Campagnolo® Cycling Apparel
132	Campagnolo® Service Center
133	Campagnolo® in the world

We were there.

Seventy-five years: a past that portrays our future



That morning of November 1927, while his hands numbed by the cold prevented him from unscrewing the wing nuts on his hub to use an easier ratio, **Tullio Campagnolo had a brainwave: redesign the nut lever** so that at least four fingers could be used to operate it. The "automatic wing nuts" patent was registered on 8 February 1930, the first of other 135 that would follow over the years.

History allows no discounts. What we are today can only be built patiently, with modesty and perseverance. Campagnolo®'s present, and even more so its future, rests on foundations consolidated by three quarters of a century studded with innovations, ideas and cycling brainwaves.

On 11th November 1927, when Tullio Campagnolo was on his own under the first ascents of the Croce d'Aune pass, he was not afraid and did not surrender. So now, as we can count on crowds of friends, enthusiasts and admirers of Campagnolo® products along our path, nothing will stop us. It is specifically from that image from the start of the century that we wish to retrace the salient milestones in our past and present history.





1933

1950

1970

1990

An alternative idea

Seventy-five years ago, in 1933, Campagnolo was founded. Soon the idea of the quick release turned out to be too constrictive for the young Campagnolo: why not redesign the entire gear? **This led to the debut of the famous "rod gear"** which marked the launch of a specific school of thought: no chain-stretcher and pulleys. Campagnolo dreamt up a completely innovative path: eliminating pulleys means reducing friction and making the system insensitive to mud. The Campagnolo® brand began to consolidate its reputation for meticulous and precise workmanship.

1940

The contribution of champions

The rod gear evolved into the Corsa 1001 version with which **Gino Bartali won the Tour de France in 1948**, and then into the Paris-Roubaix 1002 version, so-called in honour of Fausto Coppi for his victory in the homonymous race in 1950. Their respective teams, Bianchi and Legnano, also used Campagnolo® components in those years. But gear technology had arrived at a turning point: **the first derailleur with an articulated parallelogram, the Gran Sport 1012, debuted in 1950** and established the standard to which all manufacturers would soon refer.

The "groupset" is born

The second half of the fifties saw the introduction of the Record™, accompanied by a set of new components: seat post, headset, pedals and crankset. While manufacturers at the time used components made by various brands, Campagnolo went against the grain by **offering a set of components made by the same manufacturer** and designed for improved interaction with one another. This was how the "groupset" concept was born.

1960

Innovate, every time

The end of the Fifties confirmed **Campagnolo's entrance into the motoring sector.** The new Bologna works would produce superlight wheels for cars and motorbikes in Elektron magnesium alloy which in a few years would become the preferred type on British roadsters and Italian, American and German custom-built cars. Campagnolo® was the first company in the world to use the technique of casting magnesium in earth that would revolutionize the use of this material.

Even **NASA made use of it:** the Elektron alloy chassis of the OSO 6 satellite, launched in 1969, used Campagnolo® castings. Some years later this commitment led the International Magnesium Association to honour Campagnolo with the **"Design and Application Award"**.

1980

The Shamal™ era

The link between cycling champions and Campagnolo® has always been very strong. In 1994 Eugeni Berzin and Miguel Indurain, respectively, won the Giro d'Italia and the Tour de France using the **Shamal™, a wheel that revolutionized the very concept of the wheel.**

Performance and materials

The carbon fibre years were approaching. Campagnolo® selected a less conventional way to develop parts in composite material: instead of outsourcing production, the choice was made to bring the associated know-how into the company. This decision was a winning choice and allowed Campagnolo® to redevelop our components in a more modern high-performance key. **The much-admired Ergopower™ controls in carbon arrived in 1999,** followed in 2003 by the Record™ cranksets and the next year by the Hyperon™ clincher wheelset, completely made of monocoque carbon fiber, hubs included. In the race towards improved gearing, Campagnolo® continued pedalling ahead of the competition **with the introduction of the first 10-speed transmission for the Record™ and Chorus™ groupsets.**

2000



Shamal - 1994

The present and the future

The future is upon us, and various spoking techniques are being studied: **the G3™ geometry comes into being.** In 2006 the classic ISO truncated cone coupling gave way to a new standard: **Ultra-Torque™.** The new crankset makes it possible to drastically reduce lateral dimensions as the coupling between the two parts is now located in the middle of the axle. **In the meantime the company continues to look ahead. The electronic gear project is being developed** and has already been tested successfully by some professional riders in the grand tours and the Pro Tour circuit.

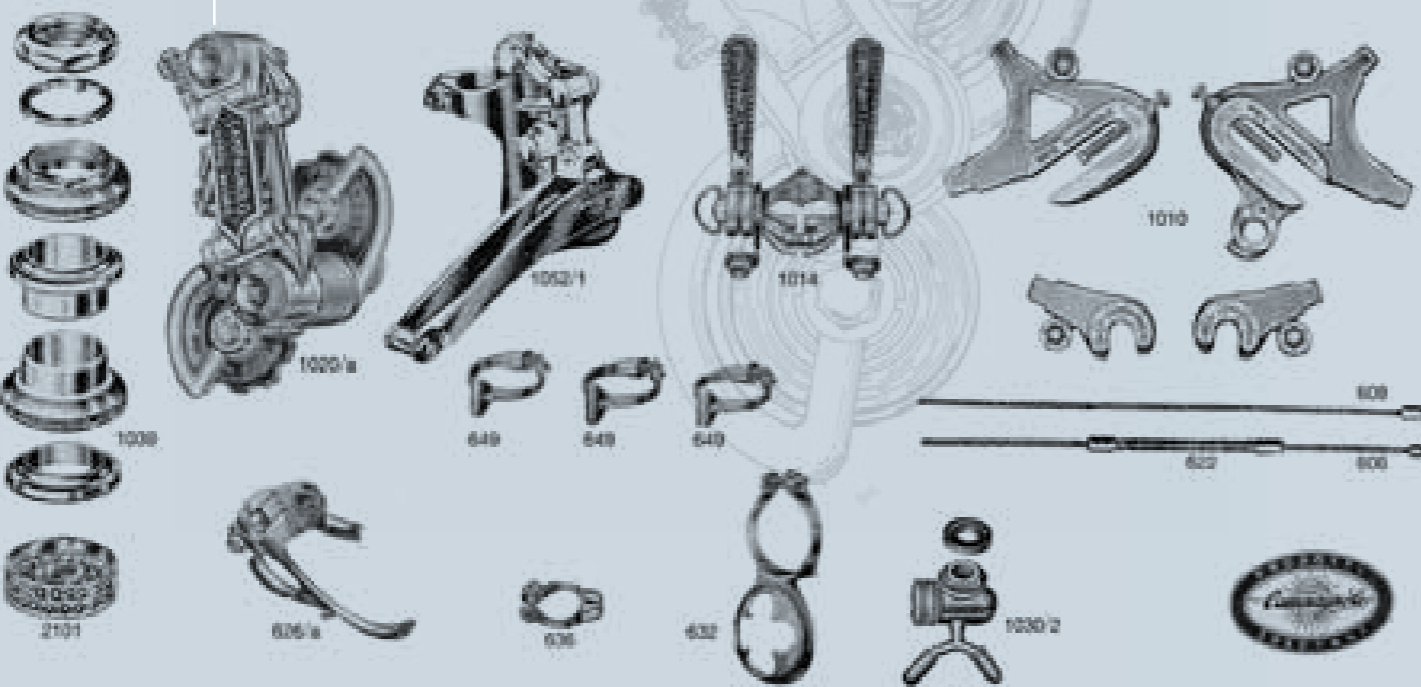

Passion 2 Win

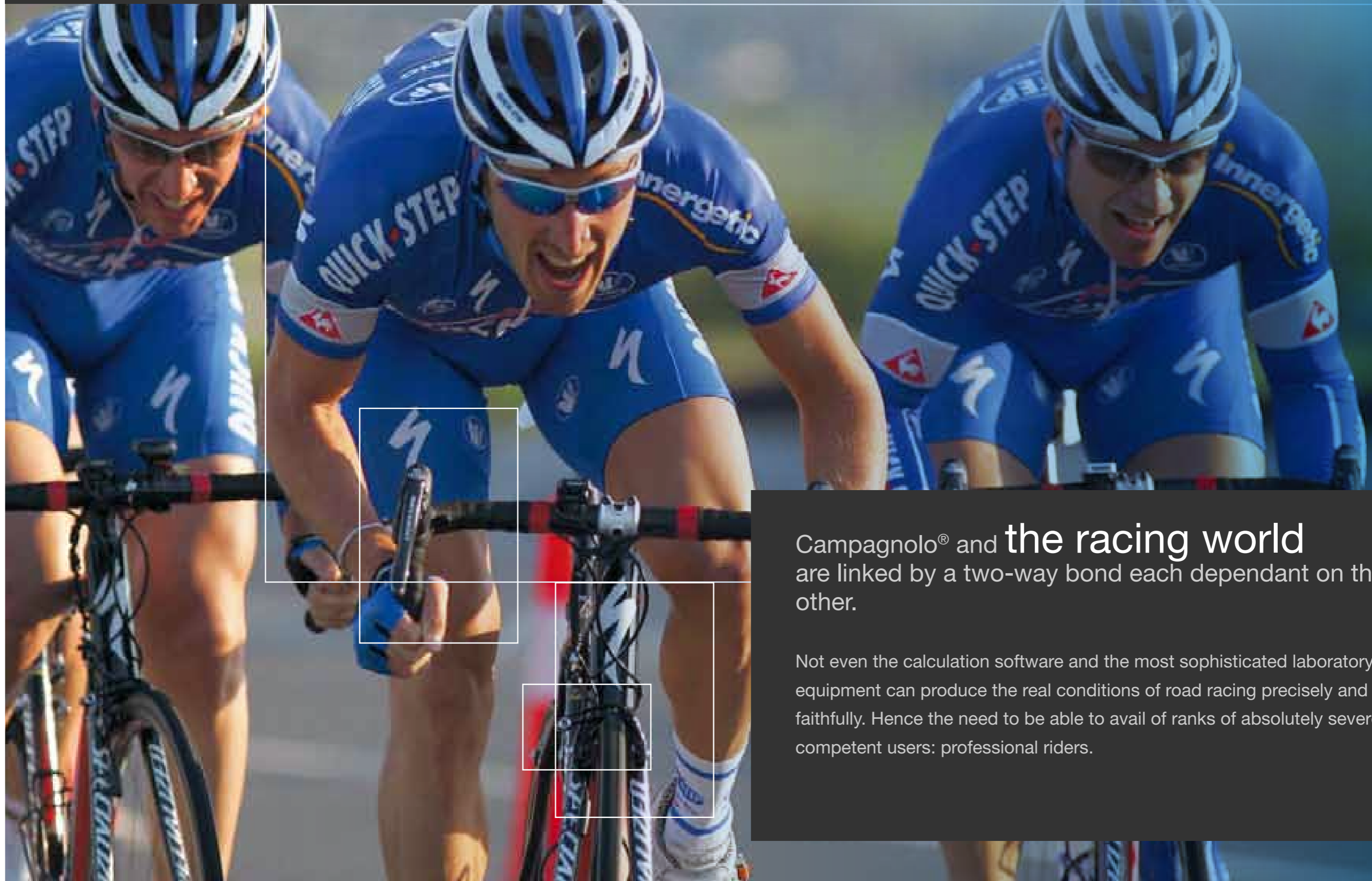

Campagnolo® and **the racing world** are linked by a two-way bond each dependant on the other.

Not even the calculation software and the most sophisticated laboratory equipment can produce the real conditions of road racing precisely and faithfully. Hence the need to be able to avail of ranks of absolutely severe and competent users: professional riders.



For over 70 years Campagnolo® has been at their side with components and wheels with the highest performance which are so reliable that riders can focus entirely on the race, certain that everything will work perfectly. The enviable history of success that only Campagnolo® can boast of is the proof of this winning bond.

2007 Professional Teams

CONTINENTAL TEAMS	FRAME	COUNTRY
Acqua e Sapone	De Rosa	Italy
G.S. Panaria	Colnago	Italy
G.S. Tenax	Pinarello	Italy
Team Jacques-T. Interim	Merckx	Belgium
Relax - Gam	Gios	Spain
Jelly Belly	Orbea	USA
Navigators	Colnago	USA
Barloworld	Cannondale	South Africa
G.S. Tinkoff	Colnago	Russia
Miyata-Subaru Racing	Koga-Miyata	Japan



2007 Professional Teams

PRO-TOUR TEAMS	FRAME	COUNTRY	TOP RIDERS
Lampre-Fondital	Wilier Triestina	Italy	Cunego, Ballan
Liquigas	Cannondale	Italy	Di Luca, Pozzato
Predictor-Lotto	Ridley	Belgium	McEwen, Evans
Quick-Step Innergetic	Specialized	Belgium	Bettini, Boonen
Ag2r	Decathlon	France	Moreau, Dessel
Bouygues-Telecom	Time	France	Brochard, Voeckler
Cofidis	Time	France	Chavanel, Verbrugghe
Caisse D'epargne	Pinarello	Spain	Valverde, Pereiro
Astana	B.M.C.	Lithuania	Vinokourov, Kloden
Unibet.Com	Canyon	Sweden	Cook, Pena

Ergopower™ controls and Ergopower™ Escape™ controls

The entire Campagnolo® production range features two types of controls: Ergopower™ Record™ and Chorus™ controls and the Ergopower™ Escape™ controls of the Centaur™, Veloce™, Mirage™ and Xenon™ groupsets.



Both are intended for controlling 10-speed systems. The classic Ergopower™ controls are characterized by the fact that the left-hand control can govern even minimum displacements of the front derailleur by means of a pawl mechanism. Furthermore, **the classic Ergopower™ controls permit a lightning shift even through five sprockets** with a single shifting action, thereby allowing you to explode in a sudden burst of energy away from the group.

By now, the carbon fibre brake lever that gives the **Ergopower lightness, reliability, mechanical strength and resistance to corrosion**, has become a distinctive element of Record™, Chorus™ and Centaur™ groupsets. The lightened mechanism runs on ball bearings for optimum actuating lightness and minimum friction.

The Ergopower™ control equipped with the Escape™ system derives conceptually from the mechanism developed for clockwork. This is because the mechanism triggers the sprockets to advance step-by-step, gradually freeing the teeth of one wheel with each oscillation. This structurally simple mechanical action reveals itself to be unparalleled in its reliability and its maintenance needs have been reduced to essential minimum. A lower number of moving parts leads to a **weight reduction of 40 g** compared with the classic control.

The brake lever is made of anodized aluminium alloy for the Veloce™ and Mirage™ groupsets and in technopolymer reinforced with long glass fibre for the Xenon™. Both materials provide rigidity, reliability, mechanical strength and a long cycle of resistance to fatigue.

Ergopower™ Flat Bar Controls: comfort with racing performance



They are available in three versions: Chorus™, with composite carbon brake levers, Veloce™, with aluminium alloy brake levers, and Mirage™ with reinforced composite brake levers.



Precision, lightness, comfort: mutually incompatible features?

Not with our Ergopower™ Flat Bar Controls, the ideal choice for those who demand full compatibility with the highest-performance road groupsets and the comfort of a raised handlebar.

Is it possible to have an appreciation of cycling technology with a non-competitive sporting disposition? Our controls for the mountain bike type of straight handlebars provide a complete answer to this question.

The Flat Bar controls have been designed to be combined ideally with all the 10-speed Campagnolo® groupsets in the catalogue, a tool of rare effectiveness and safety: **the brake lever and the shift levers are always at hand's reach**, whatever situation you are tackling

They provide the perfect solution for those who prefer the more common upright sitting position even for those who grip racing handlebars at the top. We have developed linear-pull cantilever brakes for use with the specific version of dedicated Flat Bar controls to meet the needs of riders who use bigger tyres.

Campagnolo® Flat Bar controls feature the same shifting lightness, reliability and precision which have already made the fame of the popular road models.



2008: The Ultra-Torque™ era

Lightness, rigidity, simplified assembly and maintenance: Ultra-Torque™. This is Campagnolo®'s answer in the integrated crankset sector.

You will agree on the fact that the old traditional truncated cone coupling (ISO) provided great service to an army of cyclists for many decades. It proved itself to be completely reliable, even more than recent but less effective solutions.

This is the reason we continued with this proven system through the 2006 season as we waited for the development of another system that would offer the benefits of systems with oversize axles and external cups but without their defects.

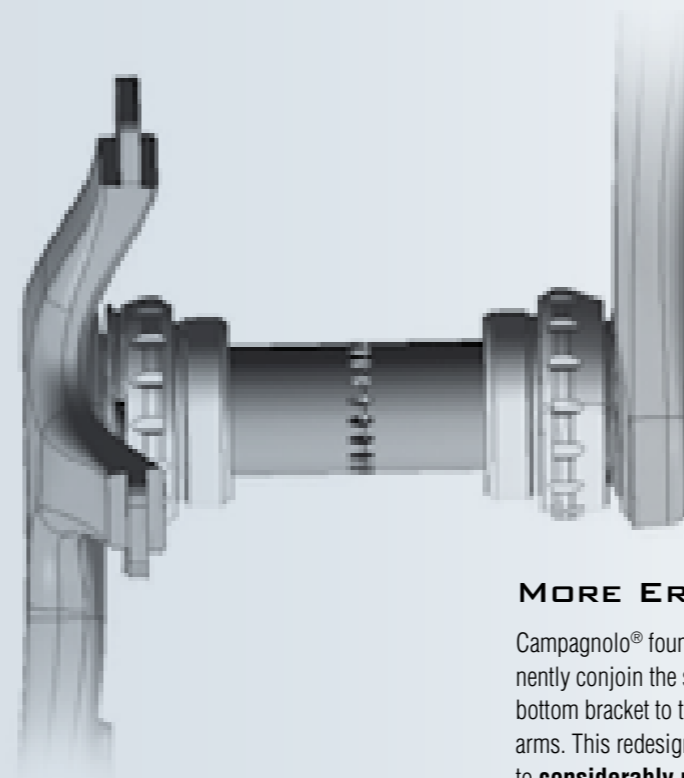

The Ultra-Torque™ cranksets are: lighter, more rigid, more ergonomic, smoother, easier to maintain.

MORE ERGONOMIC

Campagnolo® found a way to permanently conjoin the semi-axes of the bottom bracket to the respective crankset arms. This redesign made it possible to **considerably reduce the lateral dimensions** at the axle level and prevent annoying contact with the ankles when turning the pedals.

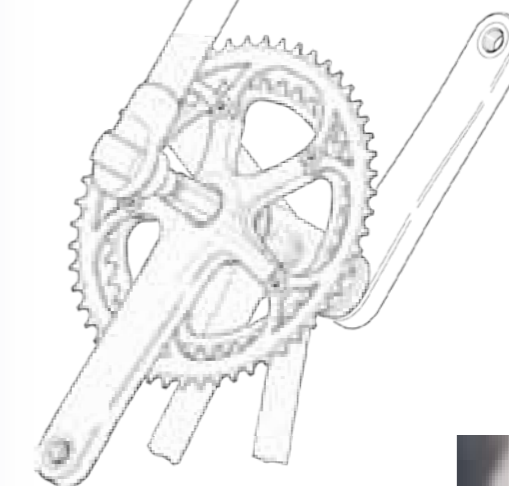

EASIER

Assembly is simplistic: one single oversize bolt is enough to integrate the two semi-axes. With regard to torque transmission efficiency, this system is equally as effective as a single piece axle.



MORE RIGID

Furthermore, despite the narrow side profile, we have been able to position the bearings outside the bottom bracket shell, resulting in greater axle rigidity from the increased axle diameter. This breakthrough was obtained by using an ingenious mechanical system derived from many years' motoring experience in the rotation axle and engine shaft coupling sector: the **Hirth joint**.

In short, this is a joint with **self-centring and self-aligning frontal teeth** located in the middle of the bottom-bracket axle where the ends of the semi-axes, integrated with the crankset arms, come into contact.



Less weight and greater rigidity for Skeleton™ brakes

Greater rigidity combined with even lower weight was the goal targeted by our engineers when designing Skeleton™ brakes. A combination that enriches virtually every groupset in the catalogue, from Veloce™ to Record™.



rear brake

front brake

Ahead of all its competitors on the market, Campagnolo has always paid particular attention to obtaining effective braking in all cycling conditions by modulating front braking compared with the rear.

Skeleton™ brakes have also been designed with this criterion: thanks to its double-fulcrum architecture, the front brake is able to grip the rim with around 70% of the total braking force; the rear brake, which only has a single fulcrum, stops the rear wheel from swerving – due to the lightening of the rear – thanks to the application of a force that is lower than at the front.

The single pin structure also makes it possible to save a few grams compared with the double-fulcrum one.

The analogy is obvious: think of the ABS on cars which prevents wheel locking when braking and think of all the safety this has provided.

Differentiated Campagnolo® braking aims to give you the same safety on your bike.

One of the key principles behind the design of every component is the discriminating choice of material. After considering the complexity of the stress map brake bodies are subject to, we established that the best material for making them remains aluminium alloy.

Our engineers have applied a basic tectonics concept to Skeleton™ brakes, one that substantially lays down two roads to follow: the use of the smallest quantity of material possible and the location of this material at the maximum distance with regard to the neutral bending axis of the section considered.

By doing so, **we optimize the component's weight-rigidity relationship** and obtain a weight reduction which is around 30 grams for the Skeleton™ Record™ brake. And this is all done while actually improving the traditional reliability of Campagnolo® braking.



A maximized weight-rigidity ratio was desired when designing the Skeleton™ brakes. To achieve this, body material was removed towards the outermost side, away from the axis of the calliper arms.

G3™ geometry: reinvent the wheel, not just its look

Campagnolo® has developed an assembly architecture which, compared with a traditional wheel, makes it possible to improve energy transfer, reduce the stress on the spokes on the right and increase transverse rigidity.

In the G3™ geometry **the right-hand side of the rear wheel is fitted with twice as many spokes as the left.**

This means that, with the same traction on the rim, each spoke is subject to about half the traction of that in a traditional wheel.

While staying well away from the maximum stress reached by a spoke in the right-hand side of a traditional rear wheel, we preferred to keep an overall higher stress level in order to guarantee **greater resistance to lateral flexure** which is exercised on the wheel in curved paths and above all when riding off the saddle on ascents.

On the freewheel body side, of course, the paired spokes are assembled using a **tangential configuration**, the only solution really able to adequately transfer the torque moment produced by chain traction without dispersing a notable quantity of energy.

The results of G3™ system are truly extraordinary:

- better transfer of the driving torque
- better lateral rigidity
- reduction of the stress in the rear wheel spokes

The asymmetrical dish of the rear wheel, resulting from the space required by the freewheel body, gives rise to a differentiated stress level in the two assembly sides.

The left-hand side of a traditional rear wheel generally records a stress level of about 60/65% of that on the right.

A difference in the traction on the rim sometimes gives rise to structural instability and loss of spoke tension on the left.



1

Sprocket set

The teeth have been specially machined to interface perfectly with Campagnolo® chain geometry and to produce perfect ratios; both when upshifting and downshifting, even when applying force to the chain.



2

Front derailleur

The job of the front derailleur is to shift the chain from one chainring to another. The front derailleur, chain and chainrings must work as a unified and cohesive unit to facilitate the athlete under pressure. This is the only way that you obtain fast and precise displacement of the chain.

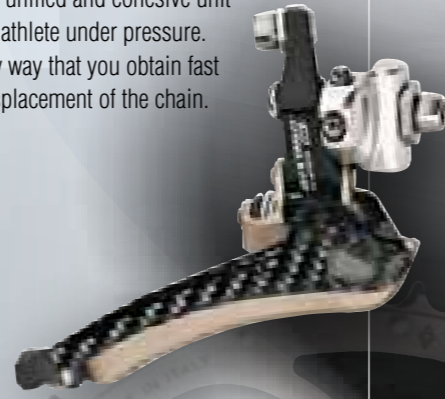

6

Rear derailleur

A complex system of springs that are balanced together means that the action of the control, transmitted by the cable, is matched by perfect shifting of the rear-derailleur parallelogram and positions the chain rapidly and silently on the selected sprocket.



5

Chain

Geometries and dimensions have been studied to couple perfectly with the chainrings and the sprockets in order to obtain fast, precise and quiet shifting, as well as better transmission of the rider's power.



4

Crankset

The chainrings are machined with Ultra-Drive™ geometry – also used for the chain and sprockets – with special operations and pins that couple perfectly with Campagnolo® chains.



What is the advantage of an integrated Campagnolo® groupset?

3

Ergopower™ controls

The cable-housing insert shifts by one calibrated angular portion and permits correct displacement of the rear derailleur parallelogram. It is only with Ergopower™ controls that you obtain precise and smooth shifting, with the possibility of shifting up to five sprockets in a single stroke.



Every rider in a team performs his specific role with dedicated professionalism in an effort to achieve a team victory. It is with this same understanding why every Campagnolo® groupset has been designed so that each component expresses its maximum potential by integrating perfectly with the other components.

Every single component is realized to excel, but it is the perfection of the whole that guarantees the result. Materials, dimensions and design: nothing is left to chance. It is only in this way that you get a groupset of components with superior performance: a Campagnolo® groupset.

GROUPSETS

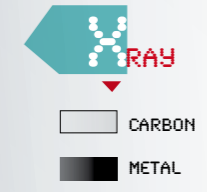

Record™ 24

Chorus™ 34

Centaur™ 42

Veloce™ 50

Mirage™ 58

Xenon™ 66

Record™Pista™ 72

TimeTrial™ 74

Triple 76

TRIA INTEGRATI RQU

ERGOPOWER

FRENI SKELETON

LEGGERI



The material used for the structure and levers is carbon composite. The use of metal parts is minimal and relegated to the internal mechanism.

PIÙ LEGGERO IN ASSOLUTO

RECORD™ GROUPSET

Record™: heart and reason. Always a synonym of absolute excellence, the Record™ groupset is the perfect balance between passion for cycling and the most advanced technology available on the market. This is the first choice of those looking for the maximum performance and reliability of their equipment, whether professional or amateur.

GIUNTO HIRTH

The most substantial technical innovation in the crankset regards the crank coupling system. Ultra-Torque™ is based on the use of a Hirth joint of the front coupling, self-aligning type, imeshed in teeth with a triangular section.

At Campagnolo® we were able to construct a crank with both hollow rod and spiders by using Ultra Hollow™ Structure monocoque technology. The cavity inside the crank arms allow for weight savings without losing strength.

Multiple chainring options, a single front derailleur

A new standardized front derailleur, versatile enough to offer optimum performance when shifting with both CT™ and traditional cranksets.

Now the need to choose the type of front derailleur on the basis of the crankset is a thing of the past. Starting from this season Campagnolo® is introducing the new standardized front derailleur, compatible with both traditional and Compact cranksets.

The geometry and the mechanical joint of this front derailleur – the outcome of in-depth study stages alternated with countless practical experiments – have been extensively redesigned.

Now it employs an internal “Z-shape™” plate, which increases rigidity and the effectiveness of the thrust on the cage, as well as a central “M-brace™” body which constrains the outer plate on both sides and enhances shifting performance. The “Even-O™” fixing clamp has also been redesigned so that the clamping load on the vertical tube of the frame is distributed more evenly, a feature which is by no means secondary considering how widespread frames made of composites are.

The cage the chain runs through is composed of aluminium alloy and composite for the Record™ series, aluminium alloy for the Chorus™ groupset and stainless steel for the remaining groupsets.

CARBON



REAR DERAILLEUR

The rear derailleur is available in two versions with a medium or short cage. Both ensure compatibility starting from the 11-21 sprocket set, up to 13-29 for the medium version and 13-26 for the short one.

The outer plate of the cage, the outer parallelogram link and the seat of the travel limit adjusters are composed of a structure made of composite material. Carbon fibre woven at 90° is used for the short cage while Multi Directional Carbon Fiber™ is used in the medium version, given the different mechanical needs.



18g

BOTTLE CAGE SECTIONS

Absolutely minimal design for the Record™ bottle cage, a monocoque structure in carbon weighing only 18 grams.



SEAT POST

The only parts in the seat post made of light alloy are the head of the seat post and the lower seat rail clamp. Instead, the shaft and the upper seat rail clamp of this component are entrusted to the unsurpassed strength of composite.



**FRONT HUB**

As the torsional rigidity of a wheel largely depends on the hub body, the dimensions of the latter were increased when it was recently redesigned in order to obtain a greater moment of inertia as a result.



The Ultra Narrow™ chain has been specially designed for the 10-speeds and is 5.9 mm wide. Its weight savings is due to the lightened links and hollow pins, while the PTFE coating also provides quiet and smooth action.



The sprocket set is an integral part of the Ultra Drive™ system which also includes the chain and crankset chainrings. It is available with three titanium toothing options and seven steel-titanium ones, of which the 11-25 is ideal in combination with the compact CT™.

TITANIO





RECORD™ SEAT POST

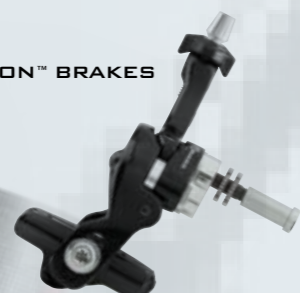

RECORD™ SKELETON™ BRAKES



RECORD™ HEADSET



RECORD™ ERGOWPOWER™ CONTROLS



RECORD™ SPROCKET SET



RECORD™ BOTTLE CAGE



RECORD™ FRONT DERAILLEUR



RECORD™ ULTRA-NARROW™ CHAIN



RECORD™ REAR DERAILLEUR



RECORD™ ULTRA-TORQUE™ CRANKSET



RECORD™ PRO-FIT PLUS™ PEDALS

Record™: It constitutes the world benchmark in terms of lightness, as it is decisively lighter overall than any other groupset on the market.



PURA PASSIONE

CHORUS™ GROUPSET

Chorus™: a high-level choice for pure passion.

There is an unequivocally competitive nature in its DNA, second only to that of the Record™. It is the top-end option aimed at those enthusiasts of high competitive calibre who demand quality at a more reasonable price.

ULTRA-TORQUE™ CRANKSET

The unidirectional carbon fibre laminated along with multidirectional carbon fibre constitutes the structural part of the arms of this crankset. Inside is a core made of low-density structural foam, but there are no metal parts.

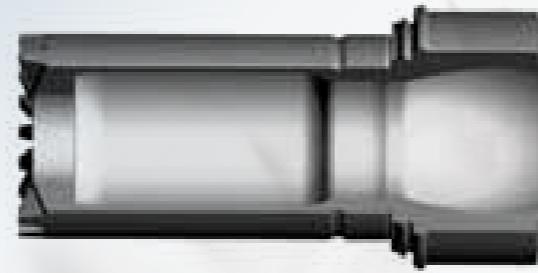

ULTRA-TORQUE™ AXLE

All the structural solidity, the **low side dimensions of the axle and the ease of assembly and maintenance** are provided by the use of the Ultra-Torque™ Hirth joint for the Chorus™ cranks too, completely redesigned for the new system.

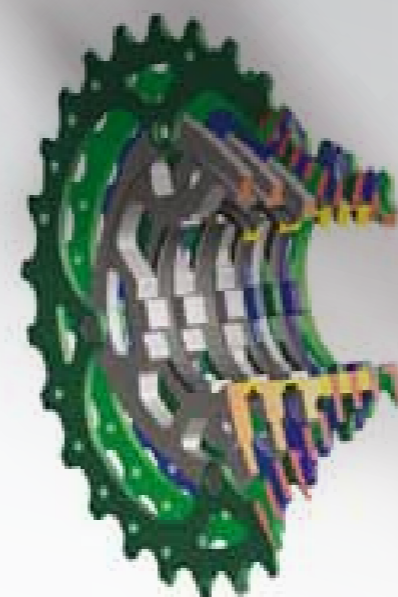

SPROCKET ASSEMBLY

The sprocket set tothing has been designed with Ultra-Drive™ geometry which **always ensures fast, precise and quiet shifting** by envisaging correct sprocket sequentiality.

DIFFERENTIAL BRAKES

ERGOPOWER™ CONTROLS

In the 2008 Chorus™ groupset Ergopower™ controls the left-hand control set-up is compatible with the QS™ system which envisages an elongated front derailleur arm for light instantaneous shifting.

SKELETON™ BRAKES

Material has been eliminated where it is less necessary and concentrated where it is possible to obtain an oversize effect. The sculpted detail of a CNC-machined body is combined in Skeleton™ brakes with the technical concreteness and the reliability of a forging.

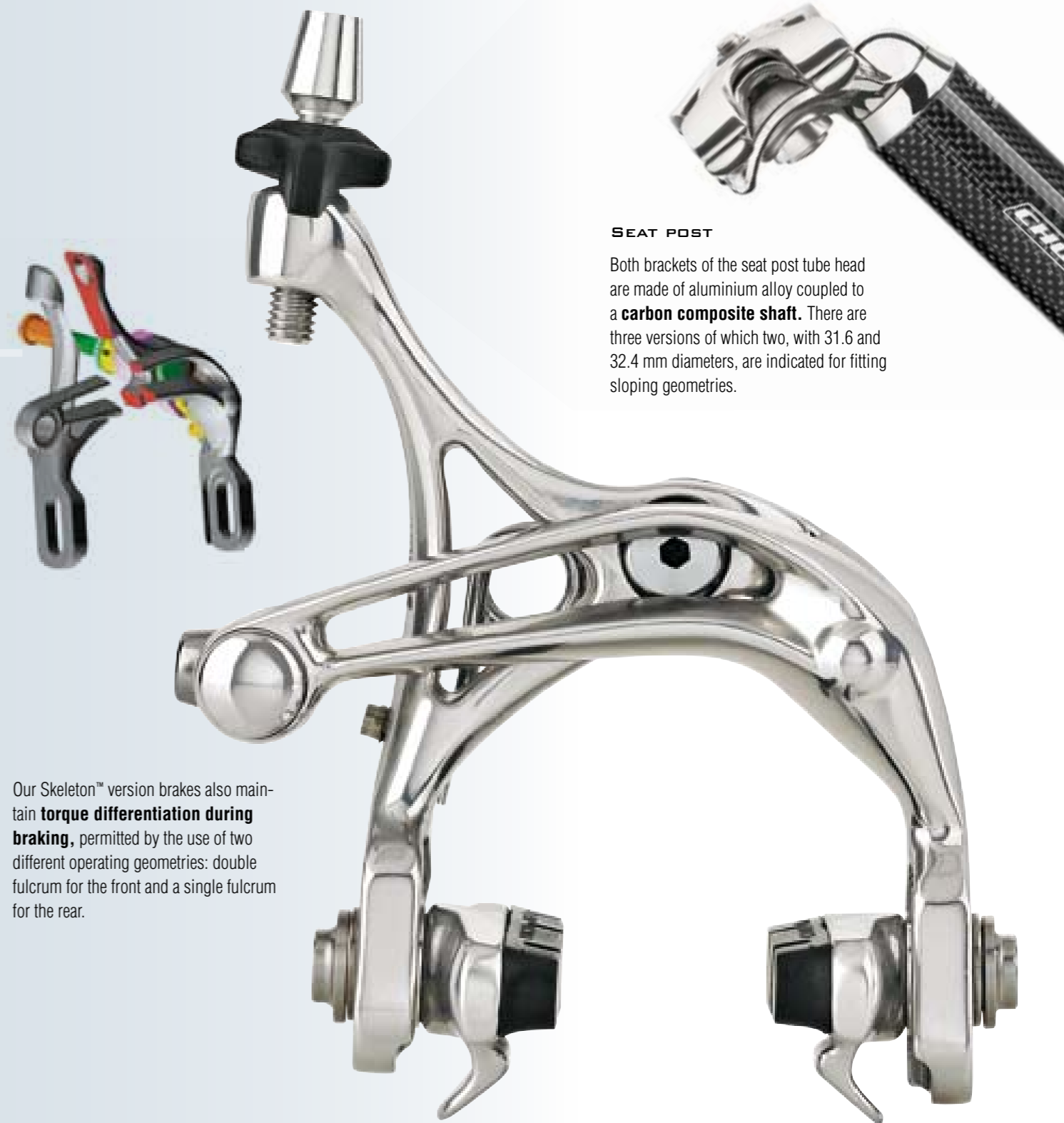

SEAT POST

Both brackets of the seat post tube head are made of aluminium alloy coupled to a **carbon composite shaft**. There are three versions of which two, with 31.6 and 32.4 mm diameters, are indicated for fitting sloping geometries.

Our Skeleton™ version brakes also maintain **torque differentiation during braking**, permitted by the use of two different operating geometries: double fulcrum for the front and a single fulcrum for the rear.



CHORUS™ SEAT POST

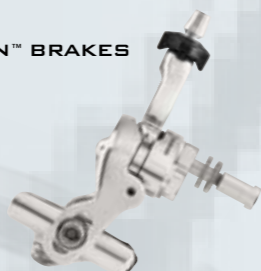

CHORUS™ SKELETON™ BRAKES



CHORUS™ HEADSET



CHORUS™ ERGPOWER™ CONTROLS



CHORUS™ BOTTLE CAGE



CHORUS™ FRONT DERAILLEUR

CHORUS™ SPROCKET SET



CHORUS™ ULTRA-NARROW™ CHAIN



CHORUS™ REAR DERAILLEUR



CHORUS™ ULTRA-TORQUE™ CRANKSET



CHORUS™ PRO-FIT PLUS™ PEDALS

Chorus™: this is the choice of high-level athletes. It shares its genetic makeup with Record™ and this designates it for competition as does its level of reliability, life and construction tolerances, even if they are obtained through the use of a few less carbon composite parts.



The Centaur™ rear derailleur is distinguished by the carbon outer parallelogram link which marks it out as a component for competitions, and forcefully underlines its positioning in the top of the range of products for racing bikes.

GRUPPOCENTAUR™

Centaur™: everything you always wanted and never dared to ask for. Top-of-the-range materials and technical solutions characterize the Centaur™ groupset, designed for those who demand medium-high performance and the most exclusive Campagnolo® look as well.

REPS
USA



CHAIN

The same construction geometry and the same parameters used for designing the Ultra Narrow™ 10s chain were applied in the design and construction of the **quiet and light** Centaur™ chain.

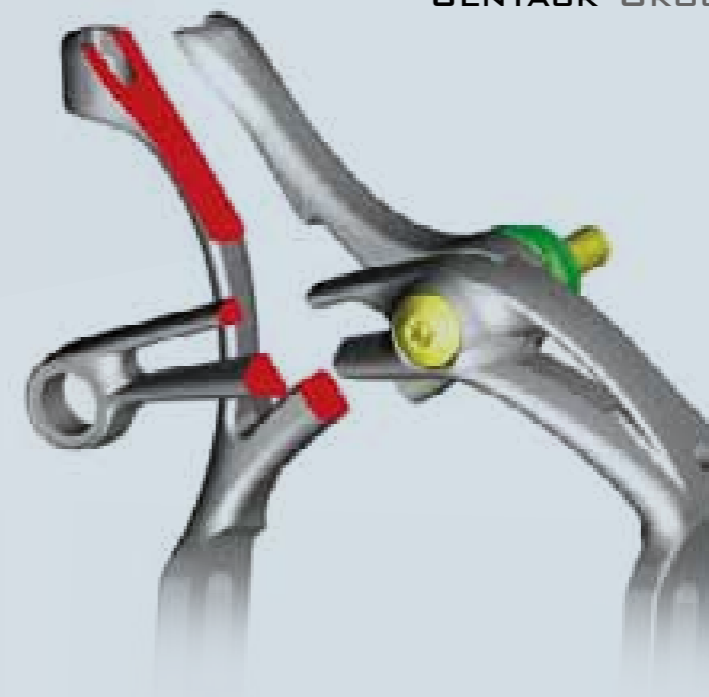

The Centaur™ groupset uses the same architecture as the Skeleton™ brakes in the high-end groupsets. The articulation of the front calliper arms is the double-fulcrum type and permits greater tightening than the rear.

BOTTLE CAGE

It was possible to fabricate an absolutely minimal structure weighing **only 35 grams**, but reliable and strong at the same time, thanks to the use of composite with multidirectional fibre, a technical feature of Campagnolo®'s carbon machining operations.



SPROCKETS

The protection of the Centaur™ groupset sprockets envisages a galvanic surface treatment with the deposit of a chromo-nickel film. The surface is then impregnated with PTFE to obtain **low friction and the maximum smoothness**.



ERGOPOWER™ CONTROLS

Reinforced carbon composite and long-fibre carbon composite are the construction materials used in Ergopower™ controls. The metal sprockets of the Centaur™ mechanism envisage the use of the Escape™ system.



Starting from this season, the forged aluminium alloy Centaur™ Ultra-Torque™ cranksets are joined by the Ultra-Torque™ Carbon cranksets in which the use of metal parts is extremely limited.

**NEW CARBON CRANK**

CENTAUR™ SKELETON™ BRAKES



SPROCKET SET CENTAUR™



CHORUS™ ULTRA-NARROW™ CHAIN



CENTAUR™ REAR DERAILLEUR



CENTAUR™ FRONT DERAILLEUR



CENTAUR™ ULTRA-TORQUE™ CRANKSET



CENTAUR™ BOTTLE CAGE



CENTAUR™ ERGPOWER™ CONTROLS



The new Ultra-Torque™ system for the cranksets is also available this year in the Carbon version; Skeleton™ architecture for the brakes; carbon for the outer plate of the rear derailleur, the bottle cage and the Ergopower™ controls: a class option at a competitive price.

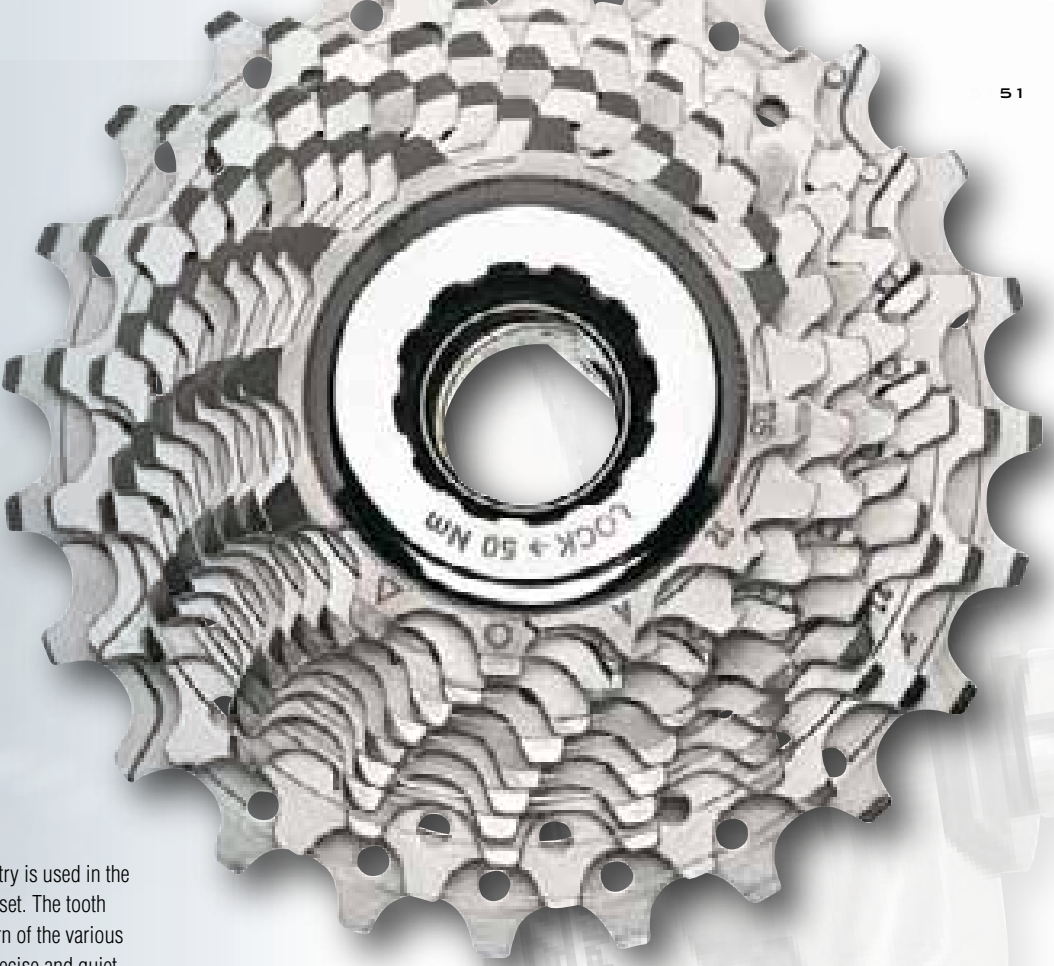

The proven Ultra Drive™ geometry is used in the design of the Veloce™ sprocket set. The tooth profile and the sequential pattern of the various sprockets make shifting fast, precise and quiet.

VELOCE™ GROUPSET

The champion of the Campagnolo® middle range. And a price-quality ratio champion too, a proposal that is now more competitive than ever: the technical features have been evolved and updated while a series of options makes it as versatile as the top-of-the-range groupsets.

FRONT DERAILLEUR

A single derailleur for both the cranksets available has been prepared for this groupset too: traditional and CT™. It also ensures **complete compatibility with the Flat Bar Ergopower™ controls** available as an option for this groupset.

**ERGOPOWER™ CONTROLS**

There is a wide selection of controls for the Veloce™ groupset: **aluminium alloy controls** of the racing type, with a lightened inner lever (for the Silver version), a composite lever (for the Infinite™ version) or Flat Bar™ controls with adjustment of the distance from the handlebar for a more relaxed steering position. The latter are available both for traditional callipers and for Linear Pull ones.

245 G

**CHAIN**

A chain that meets the same Campagnolo® standard in terms of **precision, quietness and reliability**, the Veloce Ultra Narrow™ 10s chain comprises 104 links with a width of 5.9 mm and weighs a total of 245 g.

LEGGERO
SKELETON

The Veloce™ groupset is fitted with a Campagnolo® brake of the latest generation: the Skeleton™ with differentiated braking callipers.



Also available are side-pull Linear Pull Cantilever brakes with 85 mm arms, ideal for coupling with Flat Bar controls.

The new Campagnolo® assembly standard: Ultra-Torque™, the system that employs two semi-axes integrated with the respective crank arms and equipped with a Hirth frontal joint. The use of the Ultra-Torque™ system guarantees plenty of space for ankle movement at the height of the rotation axle.

CENTAUR™ HUBS

The same design as the Centaur™ hubs – with the sole exception of the release mechanism – is repeated in the Veloce™ groupset. The hub body is of the **over-size diameter type, guaranteeing resistance to flexural strength**, while sealed precision bearings are used.

REAR DERAILLEUR

The rear derailleur of the Veloce™ groupset is available in two versions designed on the basis of the crankset chainrings used: **with long and medium cage**. There are also two finishes: Silver or Infinite™, the latter fitted with a shiny black outer plate.

SILVER

VELOCE™ SILVER / INFINITE™ SKELETON™ BRAKES



VELOCE™ SILVER ERGOPOWER™ CONTROLS

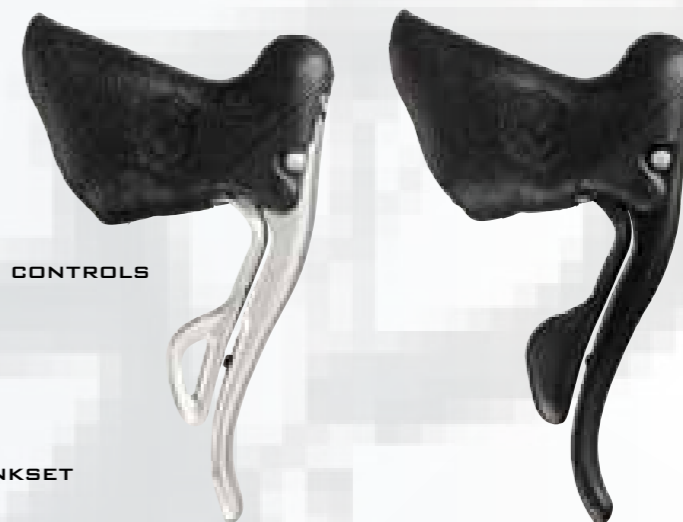

VELOCE™ INFINITE™ ULTRA-TORQUE™ CRANKSET



VELOCE™ INFINITE™ ERGOPOWER™ CONTROLS

VELOCE™ SILVER / INFINITE™ FRONT DERAILLEUR

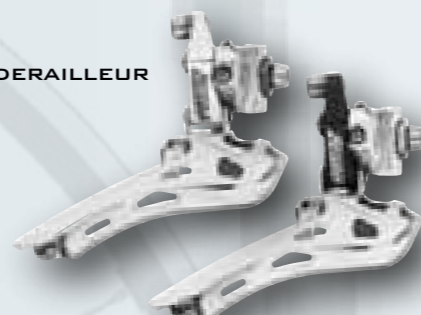

Skeleton™ brake bodies, Ergopower™ controls with composite or aluminium levers – of both the Racing and Flat-bar types – hubs with oversize bodies, the new Ultra-Drive™ sprocket set and Ultra-Torque™ cranksets. The Veloce™ groupset is available with two finishes, the aggressive Veloce™ Infinite™ gloss black version as well as the traditional polished Silver one.

VELOCE™ SPROCKET SET

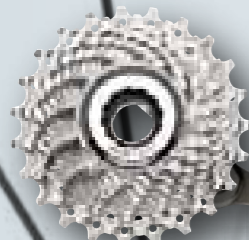

VELOCE™ ULTRA-NARROW™ CHAIN



VELOCE™ SILVER ULTRA-TORQUE™ CRANKSET



VELOCE™ SILVER / INFINITE™ REAR DERAILLEUR



CON GRINTA SEMPRE

ULTRA-TORQUE™ CRANKSET

MIRAGE™ GROUPSET

The pleasure of cycling. Cycling does not just mean competitiveness but also the pleasure of pedalling in the open air and savouring the perfumes and scenery of nice weather. But when a little determination is required, just to stay abreast, this groupset will show that it can meet all your expectations.

HUBS

These hubs with a **new generation design** feature an oversized central body and the use of sealed high-precision industrial ball bearings. The weight of the rear hub is kept particularly low by the use of a **light-alloy freewheel body**.



ULTRA-TORQUE™

NEW!

FRONT DERAILLEUR

The Mirage™ also has a unique front derailleur with a geometry designed to work superbly with standard and CT™ cranksets. **The outer arm is of the elongated type**, while the resulting lever arm increase offers **notably lighter shifting**.



ULTRA-TORQUE™ CRANKSET

The bearings in the Ultra-Torque™ system architecture **are housed in the cups located outside the bottom bracket**. The enlargement of the bearings compared with the axle allows the traction system to acquire **greater overall rigidity**.



An Ultra Drive™ chain with a width of only 5.9 mm and solid pins equip the Mirage™ groupset. It is closed by a HD-Link™ clip which simplifies and speeds up relinking operations.

REAR DERAILLEUR

The Mirage™ rear derailleur has a **body made of composite material**. The joint geometries for both versions, differentiated by the cage length, are identical to the most prestigious version.



Ergopower™ Flat Bar Mirage™ controls are dedicated to those who prefer comfort to pure performance. Designed for fitting on straight handlebars, they are ideal for those who want to pedal in a more comfortable and relaxed position.



The indexing mechanism makes the shifting action extremely light both upwards and downwards and makes it possible to shift several ratios in a single movement.



ERGOPOWER™ CONTROLS

Light-alloy levers distinguished by the aggressive black colour common to the entire groupset and identified by the lasered logo on the front. These controls use the **Escape™ system that makes it possible to reduce the weight (about 40 g) and maintenance needs** compared with the traditional mechanism.

A groupset dedicated to the use of the bike in the most leisurely sense but still without performance compromises at a technical level: included are the CT™ cranksets, often preferred for gearing down the pedal action, and Flat Bar controls, for a higher position.



ERGOPOWER™ MIRAGE™ CONTROLS

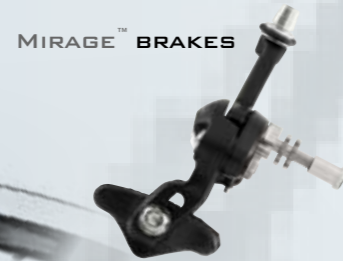

MIRAGE™ BRAKES

MIRAGE™ SPROCKET



VELOCE™ ULTRA-NARROW™ CHAIN



MIRAGE™ REAR DERAILLEUR



MIRAGE™ FRONT DERAILLEUR



MIRAGE™ ULTRA-TORQUE™ CRANKSET





Campagnolo



XENON™ GROUPSET

Welcome to the Campagnolo® household. And welcome to Xenon™, the Campagnolo® entry-level groupset which will take you into the world of precision mechanics and quality machining, where our tradition meets your passion for cycling.

IZIONE
XENON

BRAKES

The brakes included in this groupset are the same as those in the Mirage™ groupset. The **double-fulcrum mechanism** they are fitted with **and the Record™ class pads guarantee perfectly respectable performance in any road surface condition.**

CHAIN

The Ultra Narrow™ chain supplied with the groupset is the same one provided with the Veloce™ groupset. **Laboratory tests have shown that this chain has the same qualities in terms of flexibility, tensile strength, wear and elongation as the chain used in the Record™ groupset.**

SPROCKET SET

Even though it is the entry-level groupset in our range, the Xenon™ allows you to choose between **five different combinations** of galvanized steel sprocket sets.

REAR DERAILLEUR

After undergoing **redesign** in 2007 to better adapt to the needs of the 10-speed chain, the Xenon™ rear derailleur body is currently **available in two models:** one with a short 55 mm cage and another with a medium 72.5 mm one.

The Xenon™ CT™ crankset provided with this groupset employs chainrings with 34-50 teeth machined in the same way and with all the shifting aids as the Exa Drive™ system.

The cranks interface with the traditional ISO bottom bracket. It can be combined with the standardized new-geometry front derailleur for impeccable operations even under pressure.

BOTTOM BRACKET

The bottom bracket of the Xenon™ traction system employs **internal sealed cartridge bearings**. The axle of this bottom bracket is of the traditional type, an ISO standard truncated cone one, which has always shown its reliability over the years.

BLACK IS BACK



Only Campagnolo® can offer you a 10-speed groupset that boasts functional features which fear no comparison at this price level. With its makeup, which partly makes use of Mirage™ components, the Xenon™ constitutes the most interesting groupset for special bikes in the first market bracket.



ERGOPOWER™ XENON™ CONTROLS

MIRAGE™ BRAKES



MIRAGE™ SPROCKET

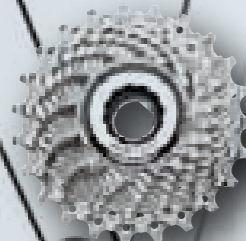

XENON™ FRONT DERAILLEUR

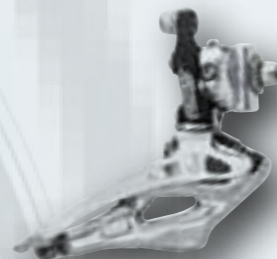

VELOCE™ ULTRA-NARROW™ CHAIN



XENON™ REAR DERAILLEUR

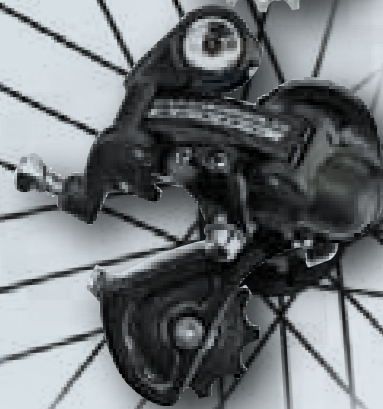

XENON™ CRANKSET



RECORD™ PISTA™

The Record™ Pista™ groupset is a set of high-range components designed to excel in the velodrome.

It includes the crankset, hubs and bottom bracket. Three products designed exclusively for the specific needs of use on the track. The other components, such as seat posts, pedals and headsets have been borrowed directly from the Record™ road groupset.

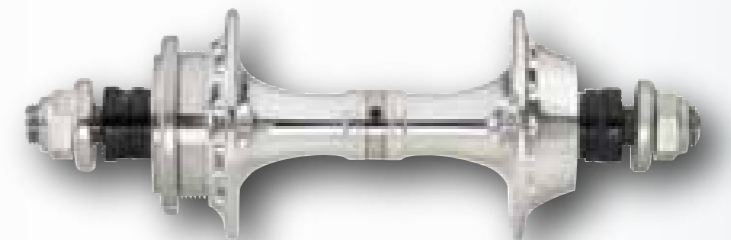
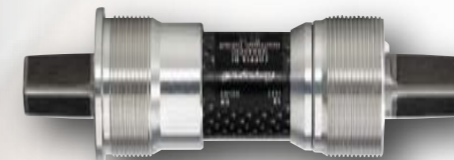

RECORD

VEL

CAMP

VELO

RECORD

TIME TRIAL™

Racing against the clock. Every detail is critical. Nothing is left to chance. Lightness and aerodynamics are the keywords. Campagnolo® dedicates various special components to time trials: bar-end controls, chainrings with oversized toothings and super-light brake levers in composite material.



TRIPLE

There are three triple drivetrain kits available for enthusiasts of the steepest climbs, two 10-speeds and a 9-speed one, to have the most agile possible ratio set at your fingertips.

The kits consist of a crankset, front derailleur and a rear derailleur with a long cage, and require the use of 111 mm and 115.5 mm ISO bottom brackets.



COMP TRIPLE™



RACE TRIPLE™



CHAMP TRIPLE™

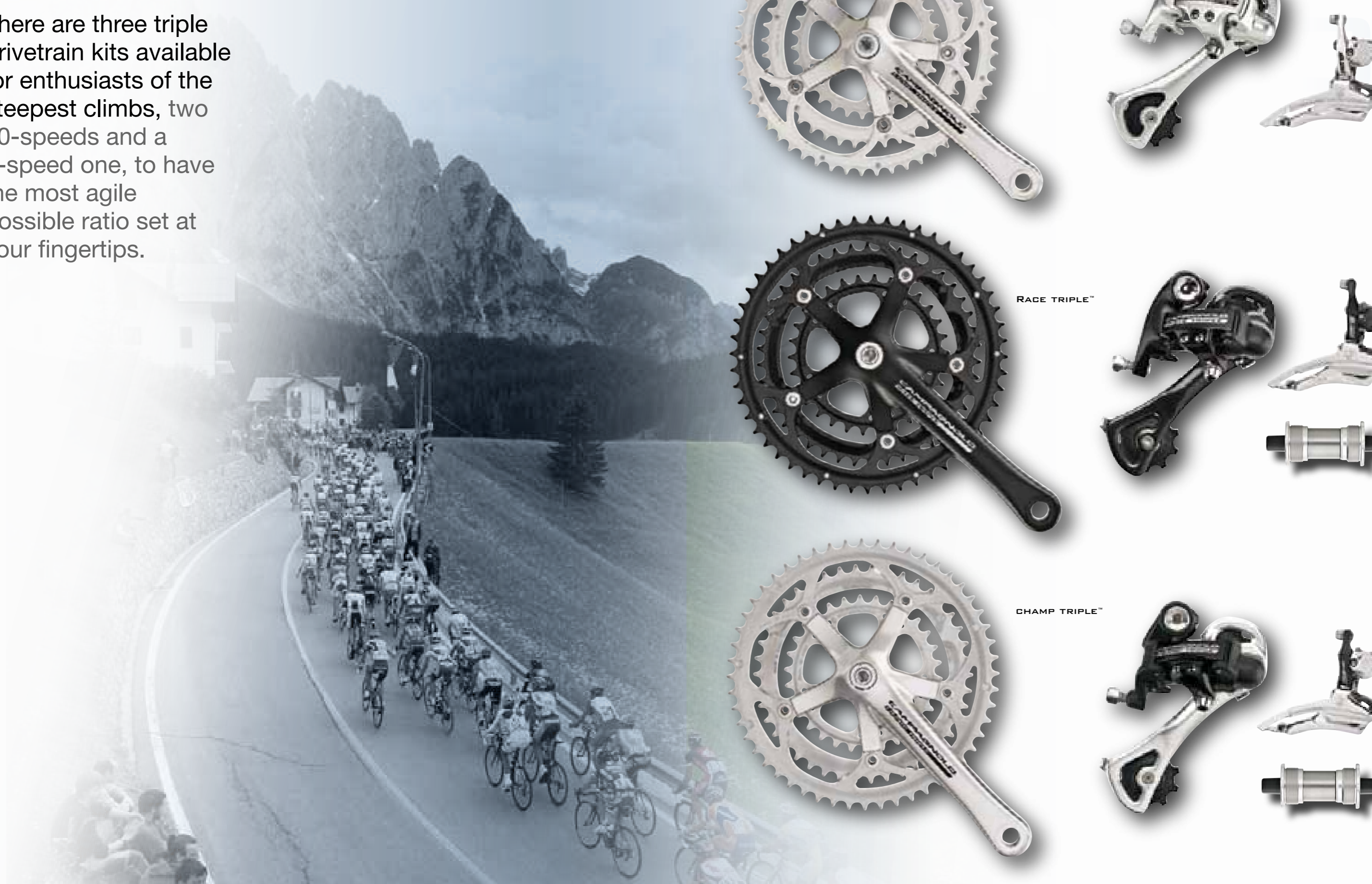

LOW-PROFILE

Long demanding ascents, nery paces, continuous restarts. When the weight of the rotating mass is the first parameter to keep as low as possible, the ideal wheel is a low-profile Campagnolo® one. The **right balance between lightness, effectiveness of torque transmission and absorption of the vibrations from the road surface.**

MEDIUM-PROFILE

In medio stat virtus? We do not know if virtue is always in the middle, but we know that when you need a wheel whose main aim is **multi-purpose use**, that wheel cannot but be a medium-profile Campagnolo®. A range characterized by the exclusive G3™ spoking which has been shown in laboratory tests to have **greater torsional and flexural strength.**

HIGH-PROFILE

Where the **need to reduce aerodynamic resistance** is fundamental, where the chronometer counts and where hundredths of a second make a difference, the right wheel can only be a high-profile Campagnolo®. Rim profiles derived from fluid dynamics and contained, low-turbulence spoking architecture constitute the main guidelines for maximum performance.

WHEELS

The quality of Campagnolo® wheels is guaranteed by painstaking manual assembly carried out by expert fitters using the strictest construction standards.

By combining the historical skills accumulated in the construction of wheels and associated components with the technical-productive potential of the Composite Materials Unit, Campagnolo® has given birth to a product of undisputable technical excellence such as the much yearned for full carbon wheels which dominate the top of world production.

Low-profile	80	Hyperon™ Ultra™
	84	Neutron™ Ultra™
	86	Neutron™
Medium-profile	88	Shamal™ Ultra™
	92	Eurus™
	94	Zonda™
	96	Scirocco™
	98	Vento™
High-profile	100	Khamsin™
	102	Bora™ Ultra™
	104	Ghibli™
	105	Pista™

HYPERON™ ULTRA™

tubular



A case study of the technical potential carbon fibre is capable of expressing. The first wheel with full-carbon rim and hub built entirely in Italy.

The first wheel entirely made of carbon fibre shipped from the Campagnolo® works, the lightest in our range and one of **the lightest worldwide in absolute terms**. The spoking adopted by the Hyperon™ is of the radial 22-element type for the front while the rear wheel uses a mixed configuration, crossed on the sprocket set side and radial on the opposite side, with 24 elements. The freewheel body is the light-alloy monolithic type. Unlike other products on the market this wheel, thanks to the shrewd use of carbon fibre, the correct lamination layout and the advanced polymerization technology, ensures a greater fatigue life working cycle than that of light-alloy wheels.

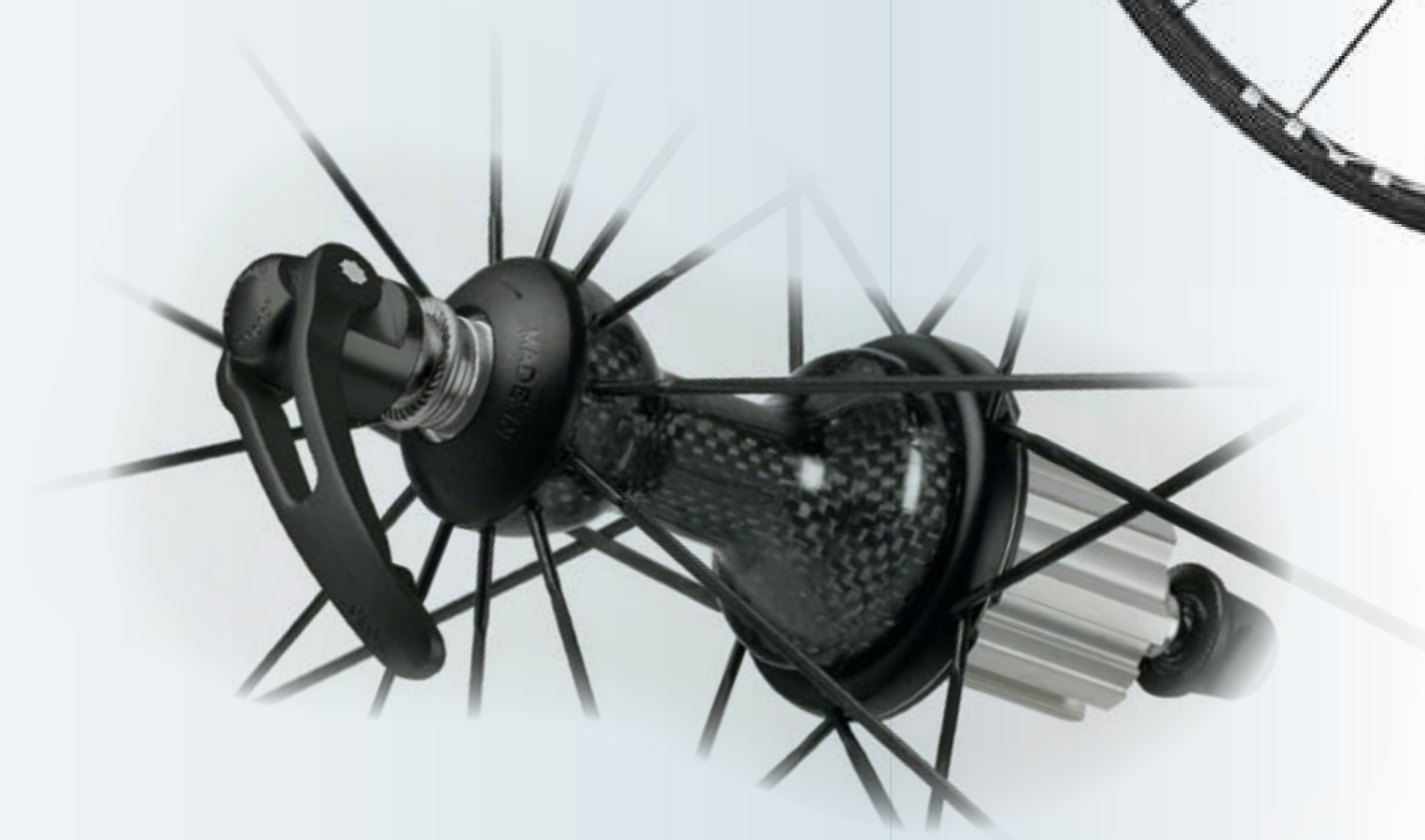

HYPERON™ ULTRA™

clincher



Building a carbon fibre rim reliable enough for the safe mounting of a clincher is a commitment that many manufacturers are happy not to make. This challenge was launched and won by Campagnolo®.

The same performance as the tubular model can be found in this clincher version. By carefully selecting the materials and finishing techniques Campagnolo® has managed to brilliantly overcome the difficulties of designing a rim capable of keeping the clincher's anchoring bead in its seat and to realize a wheel that is 200 grams below the average for the best aluminium alloy wheels.



NEUTRON™ ULTRA™

clincher



It was not easy to bring the Neutron™ to an even higher level after eight competition seasons studded by countless victories, but we managed in the end. The secret? Extreme rim extrusion calibration and carbon hubs.

Great reliability, resistance to lateral flexure when out of the saddle, sprinting response: characteristics that are all exalted even more by the **lightness** of this version of the Neutron™.

The reduction in the overall weight of this wheel was obtained both by carefully dimensioning the wall and top bridges of the rim and by fitting it with a spectacular hub with carbon fibre body and light-alloy flanges. The spokes, as usual, work on a self-locking nut coupled hemispherically with the associated support plate which provides ample support for the traction load and ensures the perfectly linear exit of the spoke.



NEUTRON™

clincher



The benchmark for time trials over hills and century rides. Transversely rigid, for an “en danseuse” ride without wasted energy, but radially comfortable so as not to tire over long distances.

The profile of the Neutron™ wheel rims has been optimized to increase **resistance to lateral flexure**. The sides of the rim, of the welded type, are ground by CNC machines to guarantee the greatest possible smoothness of the pad on the braking tracks. **The rear rim is drilled asymmetrically** to permit recovery of the difference of the spoke tension on the left-hand side compared with the right. The hubs used by the Neutron™ run on adjustable 15-ball precision bearings and the release is operated by means of a central lever with bilateral action on the locking cam.

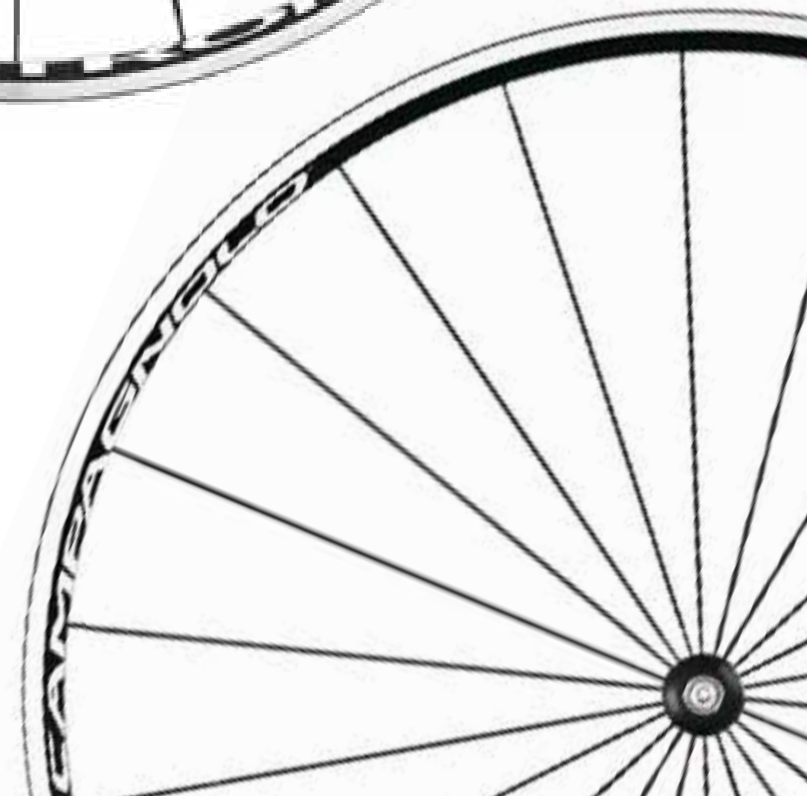
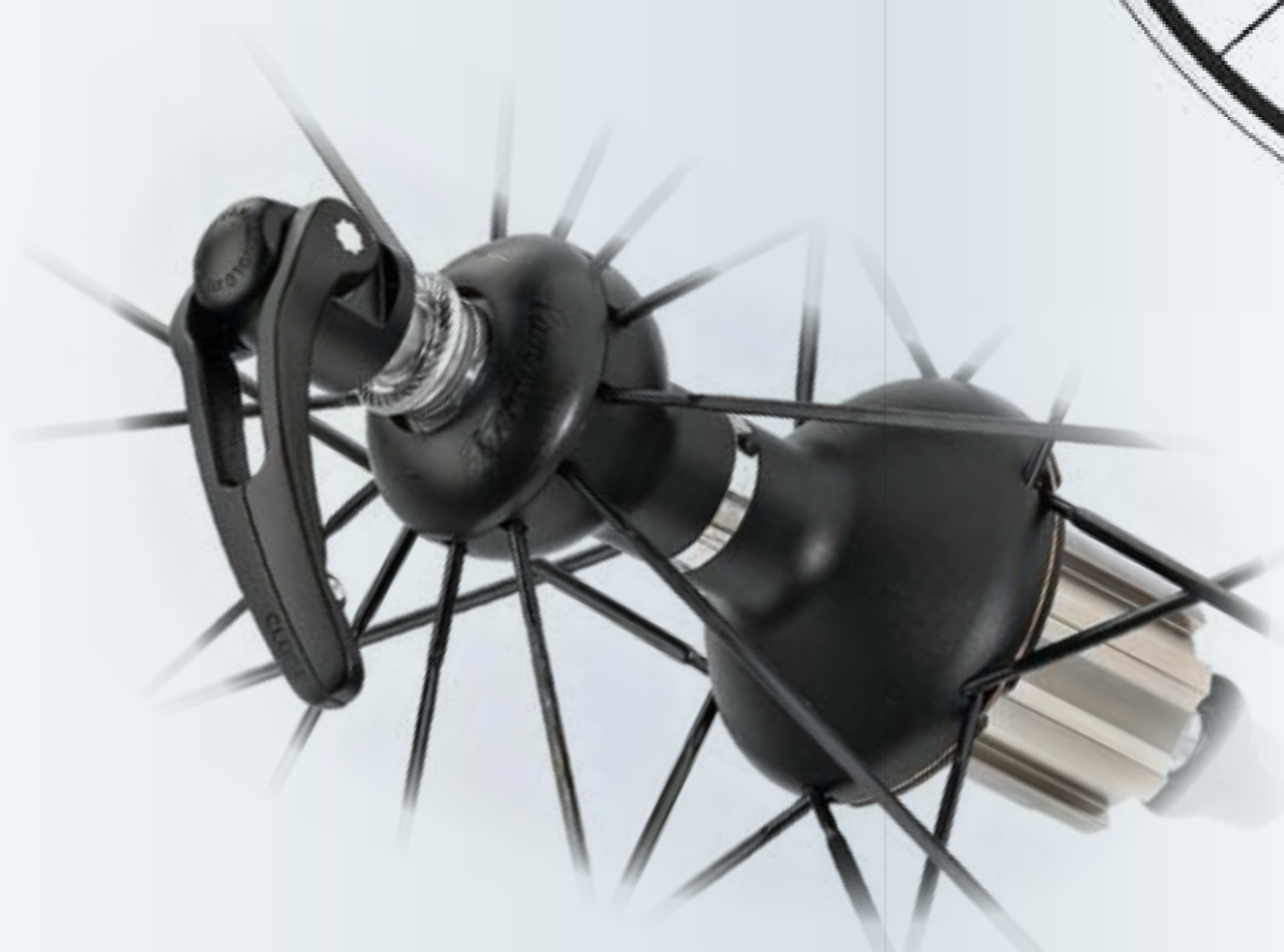

SHAMAL™ ULTRA™ GOLD

tubular / clincher



With the Shamal wheel, Campagnolo® established a turning point for the way we think about the wheel: it was the first pre-assembled wheel and fifteen years later Shamal is still inimitable.

GE

This is a historical name which for many years constituted the benchmark in the design of wheels in the cycling sector. Shamal™ wheels have evolved right up to the present with the Ultra version and have brought **all the most important innovations generated by Campagnolo® experimentation** with them. The central body of the hubs is made of carbon and the flanges are in aluminium. The profile starts from selected batches of extrusions, bent on CNC machines and with electro-welded joints. Toroidal grinding which extends from one spoke anchorage to the next helps to lighten the Shamal™ rims. The wheel has been dynamically balanced by strategic calibration of these grindings.



A Shamal™ intended for lovers of the unexcelled smoothness of tubular tyres could not be overlooked. The typical lightness of tubular tyres is combined with the intrinsic lightness of this model which stops the scales at 605 g for the front and 790 g for the rear. **A wheel which fears no comparison in terms of performance, strength, life and reliability.**



SHAMAL™ ULTRA™ TITANIUM

clincher



New

The latest arrival in the Shamal family for 2008. No photograph can ever render justice to the attractive colouring of the new Titanium version. The specifications of this thoroughbred from the Campagnolo® household are unchanged.

The new arrival in the Shamal™ family comes with a refined Titanium™ finish, the visual impact of which is enhanced by the red graphic. It possesses all the mechanical, performance and functional characteristics of the Shamal™ family. Included are the hubs with oversize carbon fibre bodies and aluminium flanges. On the right of the rear wheel is a flange with oversize diameter to increase the torsional strength and counter the torque created by the chain traction.

The bearings are very high-precision 15-ball units which are also optionally available in the smoother ceramic version.



EURUS™

clincher



A wheel which, while remaining in an absolute multi-purpose framework, is ideal in situations in which weight really counts.



Eurus™ is the best solution for tackling an ascent: the overall 1490g weight of these wheels will provide effective support when climbing the most insidious slopes. The toroidal grinding operations carried out between the spoke insertion points contribute to achieving this lightness. Differentiation of the profile was employed in this model too: 26 mm for the front rim compared with 30 mm for the rear.

The undrilled top bridge means that it is possible to do without nipple tape, just a few grams, but saved in the perimeter where every gram counts to a greater extent than elsewhere.

The assembly geometry of the Ultra Aero™ aluminium spokes is of the radial type with 16 elements for the front wheel and G3™ for the rear wheel which numbers 21 elements distributed in seven groups.



black



silver



ZONDA™

clincher



A classic model, champion of the medium-high Campagnolo® range. A determined and exquisitely technical appearance distinguishes the Zonda, a wheel with very low weight thanks to its reduced spoking.



Only 1610 g for the pair of Zonda wheels, 675 g at the front and 935 g at the rear, also due to the lightening of the rim effected in the intermediate zones between the spokes. It is the lowest-level model in the range that offers the **differentiated rim profile** concept: in this case, 24 mm side height for the front and 28 mm for the rear. This solution gives the front wheel all the response of a light and steerable rim and the rear wheel all the radial rigidity necessary for effectively transferring the torque generated by the rider: the maximum in terms of performance and reliability. Both rims have a **top bridge without holes**, a feature that makes it possible to do without nipple tape. The drilling pattern in the rear rim is asymmetrical for better spoke traction balance.



black



silver



SCIROCCO™

clincher



This is a model that was immediately appreciated by enthusiasts looking for a reliable wheel at a reasonable price. G3™ spoking for the rear wheel and radial G3™ for the front.

Radial assembly for the Scirocco front wheel, and 20 spokes with 9x3 G3™ geometry for the rear. The spokes are made of stainless steel with variable 2-1.5 mm section with aerodynamic profile. Special spokes are positioned opposite the rim joint to balance the flywheel effect and thereby obtain **dynamic balancing of the wheel**. The wheels are provided with **hubs with an oversize body** and high-precision ball bearings while **the freewheel body is the monolithic type**. The hubs are fitted with the latest generation releases with bilateral coupling on the cam axle. 770 g for the front wheel and 955 g for the rear.



black



silver

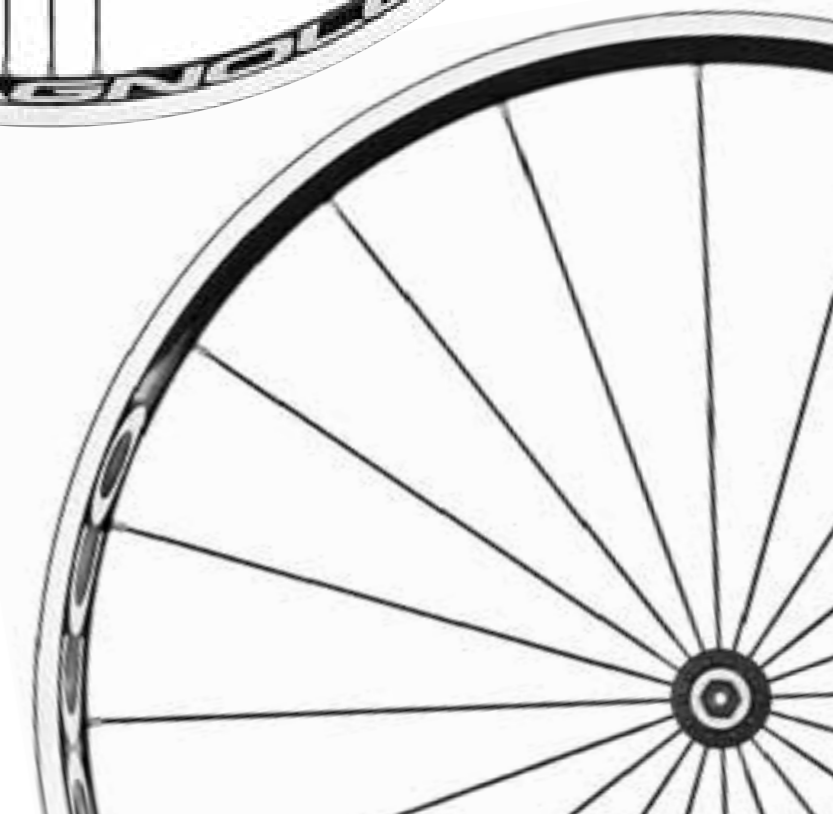

VENTO™

clincher

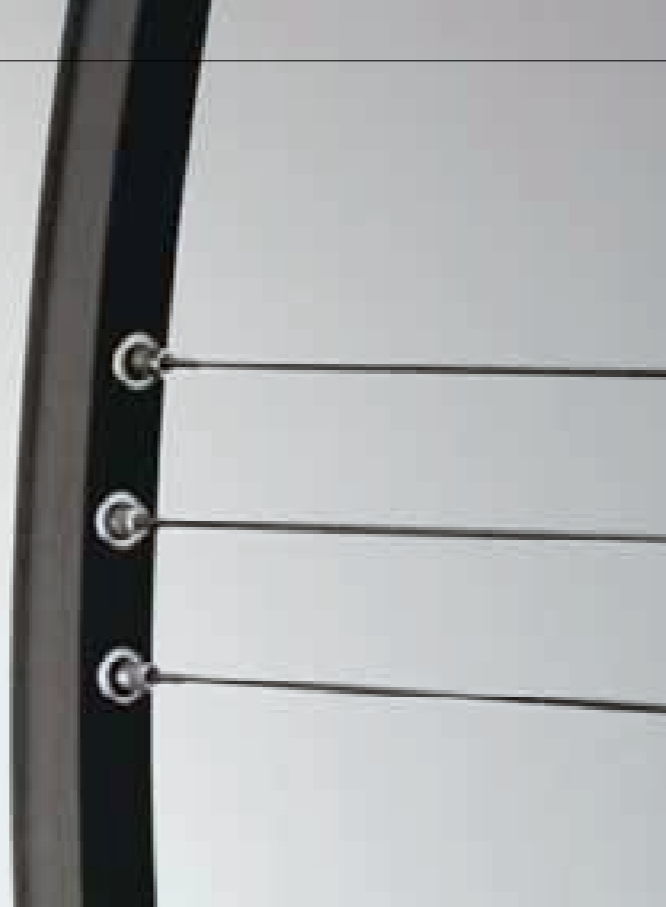

A little classic of its type. The Vento™ is available in the original Silver colour with which it achieved its popularity, but also with a black finish. The Vento™ could not go without its G3™ spoking, even in the front wheel architecture.

New Symmetric Action™ releases for Vento™ wheels

G3

Aesthetically highly attractive, these wheels are equipped both front and rear with G3™ spoking, 8x3 and 9x3 respectively. The standard spokes are of the stainless steel type with 2-1.5 mm variable section. These **wheels are dynamically balanced**, a feature achieved by adopting a pair of special spokes located on the side opposite the rim junction point in such a way that the greater weight of the spoke in question can counterbalance the weight of the joint. Their weight is very low: 810 g for the front wheel and 945 g for the rear, releases excluded. **Both hubs have oversize bodies** and are fitted with very high-precision bearings. The freewheel body and the pawl carrier in the rear hub are housed in a single aluminium block for maximum lightness.



black



silver



KHAMSIN™

clincher



Designed with particular regard to the quality-price ratio, Khamsin™ wheels never pass unnoticed with their special G3™ spoking and optional Gold finish.

New Symmetric Action™ releases for Khamsin™ wheels



The Khamsin™ is only a recent product from Campagnolo® and constitutes the entry level in the medium profile wheel framework, intended for everyday use but also for the first competitions.

The braking track on the rim is marked by the **wear indicator** which runs along the entire friction surface, making it possible to check the level of rim wall wear immediately.

The wheel's architecture is based on G3™ geometry: 24 spokes for the front wheel (radial G3™) and 27 for the rear. The hubs used are of the oversize body type and run on sealed ball bearings. Weights are moderate: 855 g for the front and 1040 for the rear.



black



gold



BORA™ ULTRA™

tubular



The mandatory choice for the maximum aerodynamic performance in time trials, especially those in which there is a side wind, and in triathlon. The 50 mm side ensures all the necessary rigidity.

For specialized professional use but more too. Bora™ Ultra™ wheels interpret technical excellence for **wheels conceived for aerodynamic performance.** Critical in this context is the imposing 50 mm rim with a wing profile calculated on the basis of the dictates of fluid physics. High performance is also obtained from the hubs, made of structural carbon fibre with variable sections and spherical surfaces with Record™ class mechanics. For Bora™ Ultra™ wheels too the G3™ 7x3 configuration was preferred for the rear wheel, and 18-spoke radial for the front, both mounted with Campagnolo® Ultralinear™ geometry. The releases with Symmetric Action™ lever, that permit better distribution of the closing load, are included in the Bora™ Ultra™.



GHIBLI™

tubular



The preferred rear wheel in time trials, the disc wheel par excellence. The profile in lens form in a single structure has shown itself to be the best choice a chronoman can make to increase aerodynamic penetration.

The historic Campagnolo® wheels designed by the wind for trials against the clock. They maximize aerodynamic performance, emphasize lightness – 955 g at the front and 995 g at the rear – and exalt the **rigidity obtained by using a sort of tensile structure made of aramidic fibre derived from aerospace technology.**

The convex lens profile typical of these wheels makes it possible to achieve ideal airflow passage on the sides by generating the minimum aerodynamic resistance. The hubs used have been specially designed for this wheel and are available in versions for road use and specifically for the track.



PISTA™

tubular



A noble and fascinating specialty with an exclusively specific feature: the transformation of the explosive power of the quadriceps of top track cyclists into pure speed, with the minimum possible waste of energy.

A wheel for a specific use compatible with tubular tyres. The rim with a height of 38 mm has been designed to **maximize rigidity and radial flexural and torsional strength.** Wheels used in velodromes, in fact, are not required to cushion inexistent surface roughness but to transfer the high traction loads that arise suddenly with the thrust of very powerful

athletes. This task is also aided by the spoking, composed of 20 spokes in the front wheel and 24 in the rear, made of stainless steel with an aerodynamic profile and aluminium nipples. The provided releases are of the specific type, with solid axles and nut fastening.



TECHNICAL SPECIFICATIONS

TECH SPEC

WARNING!

The theories covering rear derailleurs lose value when applied to real-life situations. This is due to a certain number of variables that are beyond our control. The first variable is that the chain can only be lengthened or shortened by two links at a time (106/108/110 etc.), making it impossible for the optimal length to be achieved for each frame. As a result, each time a choice is made, this shall have to be a compromise based on the technical specifications of the chainwheels, front derailleurs and frame dimensions. Further, while emphasising that the relationships between the geometries and dimensions specified by ourselves in accompanying instructions must be observed, the size and geometry of each cage influence the functionality of the various rear derailleur combinations greatly. For this reason the combinations listed in the table below are to be considered merely indicative and must be verified each and every time, depending on the frame on which the components shall actually be mounted.

RECOMMENDED COMBINATIONS

- Double or CT™ crankset + short cage rear derailleur: all Campagnolo® sprocket sets except the 13-29
- Double or CT™ crankset + medium cage rear derailleur: all Campagnolo® sprocket sets*
- Triple crankset + medium cage rear derailleur: all Campagnolo® sprocket sets except the 13-29 set
- Triple crankset + long cage rear derailleur: all Campagnolo® sprocket sets*

* if compact sprocket sets are used (e.g. 11-23) it may be necessary to keep the chain length shorter than the values indicated in standard assembly instructions.

Groupsets	108	Record™
	110	Chorus™
	112	Centaur™
	113	Veloce™
	114	Mirage™
	115	Xenon™
	116	Record™ Pista™
Wheels	116	TimeTrial™
	117	Triple
	118	Low-Profile
	120	Medium/High-Profile

RECORD™ 2008

COMPONENT	OPTIONS	DESCRIPTION	WEIGHT (G.)*
RECORD™ 10s rear derailleur	short cage	upper to lower pulley-axle: 55 mm composite outer plate - composite outer cage - Titanium hanger and pivot bolt	184
	medium cage	upper to lower pulley-axle: 72,5 mm composite outer plate - composite outer cage - Titanium hanger and pivot bolt	193
RECORD™ QS™ STD + CT™ 9s/10s front derailleur	braze-on / clip-on: Ø 32, 35 mm	for double standard and CT™ crankset - capacity 16 – max. chainring 55 – min. chainring 34 – composite and aluminum fork - M-brace™ body - Even-O™ clamp - Z-shape™ lower cage	75
RECORD™ QS™ 10s Ergopower™ shifters		for caliper brakes - double/triple crankset compatible – composite body and levers – ball bearings light alloy hardware - ErgoBrain10™ computer ready	324
RECORD™ front hub	32, 36 holes	light alloy axle and body – adjustable bearings – quick-release with aluminium lock nuts - O.L.D. 100 mm	116
RECORD™ rear hub	32, 36 holes	9s/10s - light alloy body, axle and one-piece freewheel body – adjustable bearings – quick-release with aluminium lock nuts - locking thread 27x1 - O.L.D. 130 mm	231
RECORD™ UD™ 10s sprockets - steel+titanium	11-21, 11-23, 11-25, 12-23, 12-25, 13-26, 13-29	Ultra-Drive™ - nickel-chromed finish for steel sprockets - light alloy carrier - supplied without lockring (except for 11-21, 11-23 and 11-25)	188
RECORD™ UD™ 10s sprockets - titanium	11-23, 12-25, 13-26	Ultra-Drive™ - light alloy carrier - supplied without lockring (except for 11-23)	156
RECORD™ Ultra Narrow™ chain		10s - width 5,9 mm - Ni-PTFE Finish - 114 links - Ultra-Drive™ - HD-Link™ for Ultra Narrow™ chain - lightened links - hollow pins	2,24/ link **
RECORD™ Ultra-Torque™ Carbon 10s crankset	170, 172.5, 175, 177.5, 180 mm 39-52, 39-53	Ultra-Hollow™ composite crankarms - light alloy fixing bolts and nuts - Ultra-Drive™ EPS™ chainrings with antifriction treatment - integrated ULTRA-TORQUE™ semi-axes - requires ULTRA-TORQUE™ BB overboard cups	643
RECORD™ Ultra-Torque™ CT™ Carbon 10s crankset	170, 172.5, 175 mm 34-48, 34-50, 36-50	Ultra-Hollow™ composite crankarms - light alloy fixing bolts and nuts - Ultra-Drive™ EPS™ chainrings with antifriction treatment - integrated ULTRA-TORQUE™ semi-axes - requires ULTRA-TORQUE™ BB overboard cups	643
RECORD™ Ultra-Torque™ BB overboard cups	ITA, ENG	aluminium	49
RECORD™ Pro-Fit Plus™ pedals		Titanium axle -light alloy body - with floating (standard) or fixed (optional) cleats - composite axle fixing nuts - polished aluminium finish - left axle compatible with the ErgoBrain™ magnet	266
RECORD™ D Skeleton™ brakes	front fixing bolt: 13,5 - 18,5 - 24 mm	brake-pad height adjustment ratio: 40-50 mm (measured from brake fixing-bolt to brake-shoe-nut) - ball bearings - light alloy and titanium hardware - brake pads orbital adjustment - lightened rear brake	279

COMPONENT	OPTIONS	DESCRIPTION	WEIGHT (G.)*
RECORD™ Carbon seat post	27,2 / 250 31,6 / 350 32,4 / 350	composite tube - clamp for seat tube - knurling pitch: 0.5 mm - composite upper clamp	185
RECORD™ headset		BC 1"x24tpi - height 36.5 mm	104
RECORD™ Threadless™ headset	1", 1-1/8"	for unthreaded fork tube - height 24.5 mm - composite cover and light alloy fixing screw - lubrication port	110
RECORD™ Hiddenset™ headset	1-1/8", 1-1/8" TTC™	internal headset for unthreaded fork tube - version 1-1/8": height 5.9 mm, version 1-1/8" TTC™: height 15.9 mm - patent pending system - composite and light alloy fixing screw and cap	73
RECORD™ water-bottle carrier		monocoque carbon, supplied with water-bottle	18
RECORD™ cable guide plate		to fit under bottom bracket shell - composite, suitable to oversize shells	5

* The nominal weight refers to the lighter specification among the available options. The weight of the hubs does not include the quick-release. The nominal weight does not take account of the sometimes considerable quantities of grease used in the assembly of the products.

** Example: 2,24 x 108 links = 242 g

CHORUS™ 2008

COMPONENT	OPTIONS	DESCRIPTION	WEIGHT (G.)*
CHORUS™ 10s rear derailleur	short cage	upper to lower pulley-axle: 55 mm composite outer plate	202
	medium cage	upper to lower pulley-axle: 72,5 mm composite outer plate	205
CHORUS™ QS™ STD + CT™ 9s/10s front derailleur	braze-on / clip-on: Ø 32, 35 mm	for double standard and CT™ crankset - capacity 16 – max. chainring 55 - min. chainring 34 - light alloy fork with antifriction treatment - M-brace™ body - Even-O™ clamp - Z-shape™ lower cage	76
CHORUS™ QS™ 10s Ergopower™ shifters		for caliper brakes - double/triple crankset compatible – composite body – composite levers - light alloy hardware - ErgoBrain10™ computer ready	348
CHORUS™ 10s Ergopower™ FB shifters		for caliper brakes - double/triple crankset compatible – alu-composite body – aluminium brake lever - light alloy small parts - requires QS™ front derailleur	320
RECORD™ front hub	32, 36 holes	light alloy axle and body – adjustable bearings – quick-release with aluminium lock nuts - O.L.D. 100 mm	116
RECORD™ rear hub	32, 36 holes	9s/10s - light alloy body, axle and one-piece freewheel body – adjustable bearings – quick-release with aluminium lock nuts - lockring thread 27x1 - O.L.D. 130 mm	231
CHORUS™ UD™ 10s sprockets - steel	11-23, 11-25, 12-25, 13-26, 13-29	Ultra-Drive™ - nickel-chromed finish - light alloy carrier - supplied without lockring (except for 11-23 and 11-25)	220
CHORUS™ Ultra Narrow™ chain		10s - width 5,9 mm - Ni-PTFE Finish - 114 links - Ultra-Drive™ - HD-Link™ for Ultra Narrow™ chain - lightened links	2,36/ link **
CHORUS™ Ultra-Torque™ Carbon 10s crankset	170, 172.5, 175 mm 39-52, 39-53	composite crankarms - Ultra-Drive™ EPS™ chainrings - integrated ULTRA-TORQUE™ semi-axles - requires ULTRA-TORQUE™ BB overboard cups	679
CHORUS™ Ultra-Torque™ CT™ Carbon 10s crankset	170, 172.5, 175 mm 34-48, 34-50, 36-50	composite crankarms - Ultra-Drive™ EPS™ chainrings - integrated ULTRA-TORQUE™ semi-axles - requires ULTRA-TORQUE™ BB overboard cups	679
RECORD™ Ultra-Torque™ BB overboard cups	ITA, ENG	aluminium	49
CHORUS™ Pro-Fit Plus™ pedals		steel axle -light alloy body - with floating (standard) or fixed (optional) cleats - composite axle fixing nuts - polished aluminium finish - left axle compatible with the ErgoBrain™ magnet	325
CHORUS™ D Skeleton™ brakes	front fixing bolt: 13,5 - 18,5 - 24 mm	brake-pad height adjustment ratio:40:50 mm (measured from brake fixing-bolt to brake-shoe-nut) - brake pads orbital adjustment-lightened rear brake	326
CHORUS™ Carbon seat post	27,2 / 250 31,6 / 350 32,4 / 350	composite tube - clamp for seat tube - knurling pitch: 0.5 mm	195

COMPONENT	OPTIONS	DESCRIPTION	WEIGHT (G.)*
CHORUS™ Threadless™ headset		1" - for unthreaded fork tube - height 24.5 mm - patent pending system steel and light alloy fixing screw	117
CHORUS™ Hiddenset™ headset	1-1/8", 1-1/8" TTC™	internal headset for unthreaded fork tube - version 1-1/8": height 5.9 mm, version 1-1/8" TTC™: height 15,9 mm - patent pending system - steel and light alloy fixing screw light alloy cap - 1-1/8" TTC™ without bolt washer and nut set	82
CHORUS™ water-bottle carrier		carbon and composite, supplied with water-bottle	29
RECORD™ cable guide plate		to fit under bottom bracket shell - composite, suitable to oversize shells	5

* The nominal weight refers to the lighter specification among the available options. The weight of the hubs does not include the quick-release.

The nominal weight does not take account of the sometimes considerable quantities of grease used in the assembly of the products.

** Example: 2,36 x 108 links = 255 g

CENTAUR™ 2008

COMPONENT	OPTIONS	DESCRIPTION	WEIGHT (G.)*
CENTAUR™ 10s rear derailleur	short cage	upper to lower pulley-axle: 55 mm composite outer plate	227
	medium cage	upper to lower pulley-axle: 72,5 mm composite outer plate	232
CENTAUR™ STD + CT™ 9s/10s front derailleur	braze-on / clip-on: Ø 32, 35 mm	for double standard and CT™ crankset - capacity 16 – max. chainring 55 - min. chainring 34 - antifricition insert	91
CENTAUR™ QS™ 10s Ergopower™ shifters		for caliper brakes - double/triple crankset compatible – composite body - ESCAPE™ mechanism - not compatible with ErgoBrain™	334
CENTAUR™ front hub	32, 36 holes	high quality bearings - O.L.D. 100 mm	169
CENTAUR™ rear hub	32, 36 holes	9s/10s - one-piece light alloy freewheel body – high quality bearings - lockring thread 27x1 - O.L.D. 130 mm	312
CENTAUR™ UD™ 10s sprockets - steel	11-23, 11-25, 12-25, 13-26, 13-29	Ultra-Drive™ - nickel-chromed finish - light alloy carrier - "macro" spacers - supplied without lockring (except for 11-23 and 11-25)	233
CHORUS™ Ultra Narrow™ chain		10s - width 5,9 mm - Ni-PTFE Finish - 114 links - Ultra-Drive™ - HD-Link™ for Ultra Narrow™ chain - lightened links	2,36/ link **
CENTAUR™ Ultra-Torque™ 10s crankset	170, 172.5, 175 mm	39-53 - Ultra-Drive™ chainrings - integrated ULTRA-TORQUE™ semi-axles - requires ULTRA-TORQUE™ BB overboard cups	828
CENTAUR™ Ultra-Torque™ Carbon 10s crankset	170, 172.5, 175 mm	39-53 - composite crankarms - Ultra-Drive™ chainrings - integrated ULTRA-TORQUE™ semi-axles - requires ULTRA-TORQUE™ BB overboard cups	707
CENTAUR™ Ultra-Torque™ CT™ crankset	170, 172.5, 175 mm	34-50 - Ultra-Drive™ chainrings - integrated ULTRA-TORQUE™ semi-axles - requires ULTRA-TORQUE™ BB overboard cups	828
CENTAUR™ Ultra-Torque™ CT™ Carbon crankset	170, 172.5, 175 mm	34-50 - composite crankarms - Ultra-Drive™ chainrings - integrated ULTRA-TORQUE™ semi-axles - requires ULTRA-TORQUE™ BB overboard cups	693
RECORD™ Ultra-Torque™ BB overboard cups	ITA, ENG	aluminium	49
CENTAUR™ D Skeleton™ brakes	front fixing bolt: 13,5 - 18,5 - 24 mm	brake-pad height adjustment ratio: 40÷50 mm (measured from brake fixing-bolt to brake-shoe-nut) - brake pads orbital adjustment - lightened rear brake	334
CENTAUR™ seat post		Ø 27.2 mm - L. 250 mm - light alloy tube	221
CENTAUR™ Hiddenset™ headset		1-1/8" - internal headset for unthreaded fork tube - height 5.9 mm - patent pending system - composite cap - without bolt washer and nut set	56
CENTAUR™ water bottle carrier		carbon and composite, supplied with water-bottle	35
RECORD™ cable guide plate		to fit under bottom bracket shell - composite, suitable to oversize shells	5

VELOCE™ 2008

COMPONENT	OPTIONS	DESCRIPTION	WEIGHT (G.)*
VELOCE™ 10s rear derailleur	short cage	upper to lower pulley-axle: 55 mm	250
	medium cage	upper to lower pulley-axle: 72,5 mm	259
VELOCE™ QS™ STD + CT™ front derailleur	braze-on / clip-on: 32, 35 mm	for double standard and CT™ crankset - capacity 16 – max. chainring 55 - min. chainring 34 - antifricition insert	98
VELOCE™ QS™ 10s Ergopower™ shifters		for caliper brakes - double/triple crankset compatible - composite body – ESCAPE™ mechanism - not compatible with ErgoBrain™	351
VELOCE™ 10s Ergopower™ FB shifters		for caliper brakes - double/triple crankset compatible - alu-composite body – aluminium brake lever - requires QS™ front derailleur	340
VELOCE™ 10s Ergopower™ FB shifters		for linear pull cantilever brakes - double/triple crankset compatible - alu-composite body – aluminium brake lever - requires QS™ front derailleur	340
CENTAUR™ front hub	32, 36 holes	high quality bearings - O.L.D. 100 mm	169
CENTAUR™ rear hub	32, 36 holes	9s/10s - one-piece light alloy freewheel body – high quality bearings - lockring thread 27x1 - O.L.D. 130 mm	312
VELOCE™ UD™ 10s sprockets - steel	11-25, 12-23, 12-25, 13-26, 13-29, 14-23	Ultra-Drive™ - single sprockets - nickel-chromed finish - supplied without lockring (except for 11-25)	250
VELOCE™ Ultra-Narrow™ chain		10s - width 5,9 mm - Ni-PTFE Finish - 114 links - Ultra-Drive™ - requires HD-Link™ for Ultra Narrow™ chain	2,39/ link **
VELOCE™ Ultra-Torque™ 10s crankset	170, 172.5, 175 mm	39-53 - Exa-Drive™ chainrings - integrated ULTRA-TORQUE™ semi-axles - requires ULTRA-TORQUE™ BB overboard cups	836
VELOCE™ Ultra-Torque™ CT™ 10s crankset	170, 172.5, 175 mm	34-50 - Exa-Drive™ chainrings - integrated ULTRA-TORQUE™ semi-axles - requires ULTRA-TORQUE™ BB overboard cups	821
RECORD™ Ultra-Torque™ BB overboard cups	ITA, ENG	aluminium	49
VELOCE™ D Skeleton™ brakes	front fixing bolt: 13,5 - 18,5 - 24 mm	brake-pad height adjustment ratio: 40÷50 mm (measured from brake fixing-bolt to brake-shoe-nut) - integrated shoe-holder - lightened rear brake	349
VELOCE™ linear pull cantilever brakes		for distances between brake bosses from 70 to 83 mm and for rim widths from 19.5 to 26.5 mm	378
RECORD™ cable guide plate		to fit under bottom bracket shell - composite, suitable to oversize shells	5

* The nominal weight refers to the lighter specification among the available options. The weight of the hubs does not include the quick-release. The nominal weight does not take account of the sometimes considerable quantities of grease used in the assembly of the products.

** Examples: 2,36 x 108 links = 255 g (Centaur groupset); 2,39 x 108 links = 258 g (Veloce groupset)

MIRAGE™ 2008

COMPONENT	OPTIONS	DESCRIPTION	WEIGHT (G.)*
MIRAGE™ 10s rear derailleur	short cage	upper to lower pulley-axle: 55 mm	269
	medium cage	upper to lower pulley-axle: 72,5 mm	274
MIRAGE™ QS™ STD + CT™ front derailleur	braze-on / clip-on: Ø 32, 35 mm	for double standard and CT™ crankset - capacity 16 – max. chainring 55 - min. chainring 34 - antifriction insert	106
MIRAGE™ QS™ 10s Ergopower™ shifters		for caliper brakes - double/triple crankset compatible – composite body - aluminium levers - ESCAPE™ mechanism - not compatible with ErgoBrain™	352
MIRAGE™ 10s Ergopower™ FB shifters		for caliper brakes - double/triple crankset compatible – alu-composite body - composite brake lever - requires QS™ front derailleur	340
MIRAGE™ 10s Ergopower™ FB shifters		for linear pull cantilever brakes - double/triple crankset compatible – alu-composite body - composite brake lever - requires QS™ front derailleur	340
MIRAGE™ front hub	32, 36 holes	high quality bearings - O.L.D. 100 mm	140
MIRAGE™ rear hub	32, 36 holes	9s/10s - one-piece light alloy freewheel body – high quality bearings - lockring thread 27x1 - O.L.D. 130 mm	303
MIRAGE™ UD™ 10s sprockets steel	11-25, 12-23, 12-25, 13-26, 13-29	Ultra-Drive™ - single sprockets - galvanized - supplied without lockring (except for 11-25)	259
VELOCE™ Ultra-Narrow™ chain		10s - width 5,9 mm - Ni-PTFE Finish - 114 links - Ultra-Drive™ - requires HD-Link™ for Ultra Narrow™ chain	2,39/ link **
MIRAGE™ Ultra-Torque™ 10s crankset	170, 172,5, 175 mm	39-53 - Black finish - Exa-Drive™ – steel inner chainring - integrated ULTRA-TORQUE™ semi-axles - requires ULTRA-TORQUE™ overboard cups	876
MIRAGE™ Ultra-Torque™ CT™ 10s crankset	170, 172,5, 175 mm	34-50 - Black finish - Exa-Drive™ – steel inner chainring - integrated ULTRA-TORQUE™ semi-axles - requires ULTRA-TORQUE™ BB overboard cups	861
RECORD™ Ultra-Torque™ BB overboard cup	ITA, ENG	aluminium	49
MIRAGE™ brakes	front fixing bolt: 13,5 - 18,5 - 24 mm	brake-pad height adj. ratio: 40:50 mm (measured from brake fixing-bolt to brake-shoe-nut)	340
MIRAGE™ linear pull cantilever brakes		for distances between brake bosses from 70 to 83 mm and for rim widths from 19.5 to 26.5 mm	432
RECORD™ cable guide plate		to fit under bottom bracket shell - composite, suitable to oversize shells	5

XENON™ 2008

COMPONENT	OPTIONS	DESCRIPTION	WEIGHT (G.)*
XENON™ 10s rear derailleur	short cage	upper to lower pulley-axle: 55 mm	253
	medium cage	upper to lower pulley-axle: 72,5 mm	258
XENON™ QS™ CT™ 9s/10s front derailleur	braze-on / clip-on: Ø 32, 35 mm	for CT™ crankset - capacity 16 – chainring max 50 - chainring min 34	108
XENON™ QS™ 10s Ergopower™ shifters		for caliper brakes - double/triple crankset compatible – composite body and levers - ESCAPE™ mechanism - not compatible with ErgoBrain™	363
MIRAGE™ front hub	32, 36 holes	high quality bearings - O.L.D. 100 mm	140
MIRAGE™ rear hub	32, 36 holes	9s/10s - one-piece light alloy freewheel body – high quality bearings - lockring thread 27x1 - O.L.D. 130 mm	303
MIRAGE™ UD™ 10s sprockets steel	11-25, 12-23, 12-25, 13-26, 13-29	Ultra-Drive™ - single sprockets - galvanized - supplied without lockring (except for 11-25)	259
VELOCE™ Ultra-Narrow™ chain		10s - width 5,9 mm - Ni-PTFE Finish - 114 links - Ultra-Drive™ - requires HD-Link™ for Ultra Narrow™ chain	2,39/ link **
XENON™ CT™ crankset	170, 172,5, 175 mm	Exa-Drive™ chainrings – 34-50 - requires b.b. with L. 111 mm - requires CT™ front derailleur	768
VELOCE™ bottom bracket	ITA, ENG	111 mm - cartridge b.b. - solid axle - light alloy cups	299
MIRAGE™ brakes	front fixing bolt: 13,5 - 18,5 - 24 mm	brake-pad height adj. ratio: 40:50 mm (measured from brake fixing-bolt to brake-shoe-nut)	340
RECORD™ cable guide plate		to fit under bottom bracket shell - composite, suitable to oversize shells	5

* The nominal weight refers to the lighter specification among the available options. The weight of the hubs does not include the quick-release. The nominal weight does not take account of the sometimes considerable quantities of grease used in the assembly of the products.

** Example: 2,39 x 108 links = 258 g

PISTA™ 2008

COMPONENT	OPTIONS	DESCRIPTION	WEIGHT (G.)*
RECORD™ PISTA™ front hub	32, 36 holes	light alloy body – lubrication port - small flanges - O.L.D. 100 mm	204
RECORD™ PISTA™ rear hub	32, 36 holes	light alloy body – lubrication port - small flanges - O.L.D. 120 mm	284
RECORD™ PISTA™ crankset	165, 170 mm 47, 48, 49, 50, 51, 52	requires b.b. L. 111 mm (asymmetrical)	592
RECORD™ PISTA™ bottom bracket	ITA, ENG	axle L. 111 mm (asymmetrical) - composite and light alloy cartridge - light alloy cups - without sealings	220
RECORD™ Pro-Fit Plus™ pedals		Titanium axle -light alloy body - with floating (standard) or fixed (optional) cleats - composite axle fixing nuts - polished aluminium finish - left axle compatible with the ErgoBrain™ magnet	266
RECORD™ CARBON seat post	27,2 / 250 31,6 / 350 32,4 / 350	composite tube - clamp for seat tube - knurling pitch: 0.5 mm - composite upper clamp	185
RECORD™ headset		BC 1"x24tpi - height 36.5 mm	104
RECORD™ Threadless™ headset	1", 1-1/8"	for unthreaded fork tube - height 24.5 mm - composite cover and light alloy fixing screw - lubrication port	110
RECORD™ Hiddenset™ headset	1-1/8" 1-1/8" TTC™	internal headset for unthreaded fork tube - version 1-1/8": height 5.9 mm, version 1-1/8" TTC™: height 15.9 mm - patent pending system - composite cover and light alloy fixing screw - composite/light alloy cap	73

TIMETRIAL™ 2008

COMPONENT	OPTIONS	DESCRIPTION	WEIGHT (G.)*
bar-end 10s shift. levers		composite body and lever	163
RECORD™ brake levers		composite body and lever	210
inner chainrings	42,44	Exa-Drive™ system	51
RECORD™ 10s inner chainrings	54, 55	Exa-Drive™ system	88
CHORUS™ 10s inner chainrings	54, 55	Exa-Drive™ system	88

KIT TRIPLE 2008

Champ Triple™

COMPONENT	OPTIONS	DESCRIPTION	WEIGHT (G.)*
CHAMP TRIPLE™ 9s rear derailleur		long cage - upper to lower pulley-axle: 89 mm	263
CHAMP TRIPLE™ front derailleur	braze-on / clip-on: Ø 32 mm	for triple crankset - capacity 22 – chainring max 52 - chainring min 30	118
XENON™ 9s Ergopower™ shifters		for caliper brakes - double/triple crankset compatible – composite lever and body - ESCAPE™ mechanism - not compatible with ErgoBrain™	357
CHAMP TRIPLE™ 9s Triple crankset	170, 175 mm	30-42-52 - Exa-Drive™ chainrings requires b.b. with L. 111 (for seat tube Ø 28,6 mm) or 115.5 mm (for oversize seat tube Ø 32 or 35 mm)	970
VELOCE™ bottom bracket	ITA, ENG 111, 115,5 mm	cartridge b.b. - solid axle - light alloy cups	299

Race Triple™

COMPONENT	OPTIONS	DESCRIPTION	WEIGHT (G.)*
RACE TRIPLE™ 10s rear derailleur		long cage - upper to lower pulley-axle: 89 mm	275
RACE TRIPLE™ front derailleur	braze-on / clip-on: Ø 32, 35 mm	for triple crankset - capacity 22 – chainring max 52 - chainring min 30	118
RACE TRIPLE™ 10s Triple crankset	170, 175 mm	30-42-52 - Exa-Drive™ chainrings requires b.b. with L. 111 (for seat tube Ø 28,6 mm) or 115.5 mm (for oversize seat tube Ø 32 or 35 mm)	882
VELOCE™ bottom bracket	ITA, ENG 111, 115,5 mm	cartridge b.b. - solid axle - light alloy cups	299

Comp Triple™

COMPONENT	OPTIONS	DESCRIPTION	WEIGHT (G.)*
COMP TRIPLE™ 10s rear derailleur		long cage - upper to lower pulley-axle: 89 mm	238
COMP TRIPLE™ front derailleur	braze-on / clip-on: Ø 32, 35 mm	for triple crankset - capacity 22 – chainring max 53 - chainring min 30	98
COMP TRIPLE™ 10s Triple crankset	170, 175 mm 30-40-50, 30-42-53	Ultra-Drive™ chainrings - requires b.b. with L. 111 (for seat tube Ø 28,6 mm) or 115.5 mm (for oversize seat tube Ø 32 or 35 mm)	788
CENTAUR™ bottom bracket	ITA, ENG 111, 115,5 mm	cartridge b.b. - hollow axle- light alloy cups	233

* The nominal weight refers to the lighter specification among the available options. The weight of the hubs does not include the quick-release. The nominal weight does not take account of the sometimes considerable quantities of grease used in the assembly of the products.



	nominal weight (g)*	diameter	rim material	rim section: height/width – mm (nominal)	type of rim	asymmetrical holes	requires rim tape	rim finishing	number of spokes		dynamic balance	spokes material	spoke type	differential spokes r/l	Ultralinear™ geometry	nut/nipple material	O.L.D. (mm)	hub body material	oversize hub axle	hub finishing	QR type	compatible (9/10)
Low-profile wheels																						
HYPERON™ ULTRA™ front cl.	575	28"	carb	21/20	-		•	carb	22		•	SS	AE DB		•	alu	100	carb	•	carb	20	
HYPERON™ ULTRA™ rear cl.	775	28"	carb	23/20	-	•	•	carb	24		•	SS	AE DB		•	alu	130	carb	•	carb	20	9/10
HYPERON™ ULTRA™ rear cl. (HG)	775	28"	carb	23/20	-	•	•	carb	24		•	SS	AE DB		•	alu	130	carb	•	carb	20	10**
HYPERON™ ULTRA™ front tub.	520	28"	carb	19/20	-		-	carb	22			SS	AE DB		•	alu	100	carb	•	carb	20	
HYPERON™ ULTRA™ rear tub.	700	28"	carb	21/20	-	•	-	carb	24			SS	AE DB	•	•	alu	130	carb	•	carb	20	9/10
HYPERON™ ULTRA™ rear tub. (HG)	700	28"	carb	21/20	-	•	-	carb	24			SS	AE DB	•	•	alu	130	carb	•	carb	20	10**
NEUTRON™ ULTRA™ front cl.	630	28"	alu	18/20	M		•	black	22			SS	AE DB		•	alu	100	alu/carb	•	blk/carb	20	
NEUTRON™ ULTRA™ rear cl.	840	28"	alu	18/20	M	•	•	black	24			SS	AE DB	•	•	alu	130	alu/carb	•	blk/carb	20	9/10
NEUTRON™ front cl.	660	28"	alu	18/20			•	black	22			SS	AE DB		•	alu	100	alu	•	black	40	
NEUTRON™ rear cl.	890	28"	alu	18/20		•	•	black	24			SS	AE DB	•	•	alu	130	alu	•	black	40	9/10

KEY

M = Milled
 MT = Toroidal Milling
 DB = Butted
 AE = Aero

UAE = Ultra Aero
 SS = Stainless steel
 BR = Brass
 QUICK RELEASES: 20, 30, 40

* The weight of the wheels does not include the quick release.
 ** only 10s sprockets of Shimano Inc. starting from 11 and 12.

	nominal weight (g)*	diameter	rim material	rim section: height/width – mm (nominal)	type of rim	asymmetrical holes	requires rim tape	rim finishing	number of spokes		dynamic balance	spokes material	spoke type	differential spokes r/l	Ultralinear™ geometry	nut/nipple material	O.L.D. (mm)	hub body material	oversize hub axle	hub finishing	QR type	compatible (9/10)	requires special sprocket set
Medium-profile wheels																							
SHAMAL™ ULTRA™ front tub.	605	28"	alu	24,5/20	MT		-	gold	16		•	alu	AE DB		•	alu	100	alu/carb	•	blk/carb	20		
SHAMAL™ ULTRA™ rear tub.	790	28"	alu	28,5/20	MT	•	-	gold	21/G3™		•	alu	AE DB		•	alu	130	alu/carb	•	blk/carb	20	9/10	
SHAMAL™ ULTRA™ rear tub. (HG)	790	28"	alu	28,5/20	MT	•	-	gold	21/G3™		•	alu	AE DB		•	alu	130	alu/carb	•	blk/carb	20	10**	
SHAMAL™ ULTRA™ front cl.	605	28"	alu	24/20	MT			gold/ti	16		•	alu	AE DB		•	alu	100	alu/carb	•	blk/carb	20		
SHAMAL™ ULTRA™ rear cl.	790	28"	alu	28/20	MT	•		gold/ti	21/G3™		•	alu	AE DB		•	alu	130	alu/carb	•	blk/carb	20	9/10	
SHAMAL™ ULTRA™ rear cl. (HG)	790	28"	alu	28/20	MT	•		gold/ti	21/G3™		•	alu	AE DB		•	alu	130	alu/carb	•	blk/carb	20	10**	
EURUS™ front cl.	660	28"	alu	24/20	MT			slv/blk	16		•	alu	AE DB		•	SS	100	alu	•	slv/blk	20		
EURUS™ rear cl.	890	28"	alu	28/20	MT	•		slv/blk	21/G3™		•	alu	AE DB		•	SS	130	alu	•	slv/blk	20	9/10	
EURUS™ rear cl. (HG)	890	28"	alu	28/20	MT	•		slv/blk	21/G3™		•	alu	AE DB		•	SS	130	alu	•	slv/blk	20	10**	
ZONDA™ front cl.	675	28"	alu	24/20	M			slv/blk	16		•	SS	UAE		•	BR	100	alu	•	slv/blk	20		
ZONDA™ rear cl.	935	28"	alu	28/20	M	•		slv/blk	21/G3™		•	SS	UAE		•	BR	130	alu	•	slv/blk	20	9/10	
ZONDA™ rear cl. (HG)	935	28"	alu	28/20	M	•		slv/blk	21/G3™		•	SS	UAE		•	BR	130	alu	•	slv/blk	20	10**	
SCIROCCO™ front cl.	770	28"	alu	24/20			•	slv/blk	20		•	SS	AE DB			BR	100	alu	-	slv/blk	40		
SCIROCCO™ rear cl.	955	28"	alu	24/20			•	slv/blk	27/G3™		•	SS	AE DB			BR	130	alu	-	slv/blk	40	9/10	
VENTO™ front cl.	810	28"	alu	24/20			•	slv/blk	24/G3™		•	SS	DB			BR	100	alu	-	slv/blk	40		
VENTO™ rear cl.	945	28"	alu	24/20			•	slv/blk	27/G3™		•	SS	DB			BR	130	alu	-	slv/blk	40	9/10	
KHAMSIN™ front cl.	855	28"	alu	24/20			•	blk/gold	24/G3™			SS				BR	100	alu	-	blk/gold	40		
KHAMSIN™ rear cl.	1040	28"	alu	24/20			•	blk/gold	27/G3™			SS				BR	130	alu	-	blk/gold	40	9/10	
High-profile wheels																							
BORA™ ULTRA™ front tub.	565	28"	carb	50/20	-		-	carb	18		•	SS	AE DB			alu	100	carb	•	carb	20		
BORA™ ULTRA™ rear tub.	740	28"	carb	50/20	-		-	carb	21/G3™		•	SS	AE DB			alu	130	carb	•	carb	20	9/10	
BORA™ ULTRA™ rear tub. (HG)	745	28"	carb	50/20	-		-	carb	21/G3™		•	SS	AE DB			alu	130	carb	•	carb	20	10**	
GHIBLI™ rear road	995	28"	alu	D/19	-		-	-	-		-	Aramide	-	-	-	-	132	alu	•	-	20		•
GHIBLI™ front track	860	26"	alu	D/19	-		-	-	-		-	Aramide	-	-	-	-	100	alu	-	-	-		
GHIBLI™ front track	955	28"	alu	D/19	-		-	-	-		-	Aramide	-	-	-	-	100	alu	-	-	-		
GHIBLI™ rear track	995	28"	alu	D/19	-		-	-	-		-	Aramide	-	-	-	-	120	alu	-	-	-		
PISTA™ front tub.	995	28"	alu	38/20			-	black	20			SS	AE			alu	100	alu		black	20		
PISTA™ rear tub.	1110	28"	alu	38/20			-	black	24			SS	AE			alu	120	alu		black	20		

KEY

M = Milled
 MT = Toroidal Milling
 DB = Butted
 AE = Aero
 UAE = Ultra Aero
 SS = Stainless steel
 BR = Brass
 QUICK RELEASES: 20, 30, 40

* The weight of the wheels does not include the quick release.
 ** only 10s sprockets of Shimano Inc. starting from 11 and 12.

Campagnolo® , built to last over time.

Campagnolo® components are made to last. Compliance with severe inspection tests which certify their performance over time and the support of a wide range of available spares in our global service network mean products that guarantee many years of pleasurable cycling.

Our company's approach to the market, even before any kind of international standardization was dreamt of, has always been based on particular care for ease of maintenance and the interruption-free operation of our products.

Another example that clearly testifies to the application of our philosophy of attention to the product's life cycle is provided by the Ergopower™ control.

The mechanism of our Ergopower™ is easily accessible – to specialized personnel obviously – for maintenance operations and for the replacement of mechanical parts when necessary. This possibility notably extends the product's life cycle and ensures that it works perfectly over the years.



Attention to detail also permitted Campagnolo® to establish its market leadership in road-racing from the after-sales standpoint. **Rejection of the simplistic “disposable” culture** and the particular attention paid to the product's life cycle required the presence of a **vast spare parts warehouse**, composed of 1,800 product codes, as well as the provision of a **global service network** to ensure the perfect operation of Campagnolo® groupsets with the passage of time.

In many cases the **spare parts are available for many years**, especially with regard to components and groupsets with a wide market distribution.

Furthermore, what distinguishes a Campagnolo® component is not just the possibility of intervening extensively on its maintenance, but the fact that it exceeds all the safety requirements in accordance with the test methods contained in the new European UNI EN 14781 standards. Among these we would like to recall those very important ones carried out to simulate a component's fatigue life, namely the number of stresses it can sustain without breaking or being deformed. **Campagnolo® components consistently exceed these tests**, often going far beyond the limits set by the standards, and record **long-term performance levels** that not everyone can boast of.

An avant-garde industrial set-up



Composite Materials Area
Created at the end of the Nineties, the **Composite Materials Unit produces all the Campagnolo® parts and components in carbon** and employs all of 135 people. The working of carbon fibre requires great manual skills for die preparation, laying the laminations and in the finishing processes. The output belongs to the sphere of advanced industrial technology.

The company

In each Campagnolo® product you will find **the experience, the know-how and manual skills** of over 400 employees in the historical HQ at Via della Chimica in Vicenza. Five branches and nine agencies covering 30 countries provide for the ramified distribution of our products worldwide.



Tests and inspections

To validate our products we have created **special laboratory machines that reproduce the stresses of use on the road**. We control the behaviour over time and the fatigue life through test protocols drawn up by ourselves and which habitually exceed the limits laid down by international testing technical standards.

In its HQ at Via della Chimica in Vicenza you will find all the professionalism and skill that Campagnolo® employs in the production of its components. The Composite Materials Department, where the carbon fibre is worked, and the advanced Testing Unit contribute to the formation of a structure that distributes its products all over the world.



The World of Campagnolo® at your disposal

Various collateral initiatives show how close Campagnolo® is to its fans, all the more important for the 75th anniversary celebrations.

Above all **Passion 2 Ride**, a two-day event which will be held during the weeks concomitant with the most important century rides: Gran Fondo Campagnolo® and Maratona dles Dolomites. The exceptional instructors are various former cycling professionals who will hold theoretical-practical technical courses and they will also be joined, among others, by countless celebrities from the world of journalism, television and sport.

A second initiative, dedicated to those who wish to express their creativity, is the **Bora Art Contest**, a competition where anyone, whether an artist or not, can **create the graphic design for the Bora™ wheel**. The ten final wheels will not only be published on the website but will also be built and exhibited at the main international fairs in the sector. The public will then decide upon the three poll-toppers who will each win a bicycle.

Another appointment not to be missed is the **Granfondo Internazionale Campagnolo®** - the Campagnolo® International Century Ride - an event managed by UC Pedale Feltrino which will wind through itineraries of three different lengths on the third Sunday of June, amid some of the most stunning scenery in the Dolomites.

The Campagnolo® site has always been a special company tool for communicating both with enthusiasts and with operators in the sector and for this reason particular care is taken with its styling and updating.

Graphically attractive and extremely functional, the site features a wealth of technical information on the products, services and racing world.

The section dedicated to corporate news and to the product is ideal for understanding the progress of a company which combines tradition with the most advanced technology. Unquestionably more exciting is the space dedicated to competitive racing and Mad-4Campy, a meeting point for Campagnolo® fans who, by registering for the Newsletter, will be able to stay up to date at all times with regard to the events promoted and to what happens in the Campagnolo® world.



Campagnolo Pro Shop™

More product-focused and oriented towards fast and effective service is the organization of the Worldwide Pro-Shop Project, namely the worldwide network of **Campagnolo Pro Shop™** outlets. This is a dense network of shops distributed in a capillary manner to provide the support of qualified and technically up-to-date personnel, fully and adequately equipped, belonging to the Campagnolo® Express Spares Service and availing of the Pro-Shop™ program for the use of maintenance booklets that accompany every bicycle assembled with a Campagnolo® groupset: in other words **total and complete after-sales support** for our products. The list of Pro-Shop is available on our website, www.campagnolo.com.

Full spectrum invention! The Campagnolo® corkscrew faithfully reflects the genius of its inventor, Tullio Campagnolo.

A really awkward bottle and a corkscrew that wasn't up to the job were the cause of this new stroke of genius that has not been bettered since 1966. The patented system of the telescopic self-aligning cover always places the screw in the central part of the cork. The large screw in hardened steel with a wide and sharp profile provides maximum grip on the cork and the two large levers enable the corks to be pulled out of

bottles of the finest vintages without disturbing the sediments that are typical of such wines. These technical features and the use of the finest raw materials have made this corkscrew a must, a symbol of genius that is recognized throughout the world.



Campagnolo
CYCLING APPAREL

...and it's always a
perfect day.

For those who want to challenge the fury of the elements in total safety and discover both the pleasure of performance and the privilege of comfort.

For those in search of breathtaking emotions who know how to enjoy the quiet during the storm.

For those with heart, muscles and passion to spare.

The four seasons will be neither too hot nor too cold.

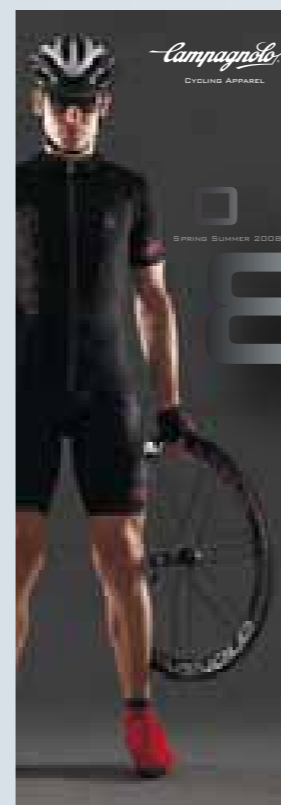

Download the complete catalogue from our site: www.campagnolosportswear.com

Tecno Cool

Cutting-edge technology and up-to-date style have been developed by Campagnolo® Cycling Apparel for cyclists who demand the ultimate sportswear solution.



RACING™

Through storm and blazing heat, let the weather do its worst. Take up the challenge. Style is the privilege of the few. It's passion.



RACING™ WOMEN

There's something magic in the air. It may be the sun, it may be the wind. It is certainly you. Mile after mile, the endless rise will become sweeping descent. You're on your way. Beauty is a fighting spirit.



RAYTECH™

Lashing rain,
endless downpour.
Just get into the rhythm:
concentrate, breathe,
push hard.

Precision in
every move.

Balance is key.



FACTORYTEAM™

The absolute beauty
of a sunny day,
making you feel special.
You're cycling with
confidence, light and
swift. You and your
bicycle.

The freedom to move.



HERITAGE™

Clouds everywhere.
Uphill there may be snow.
You can feel the spirit of the brave.
You will never give in.

Today the legend is you.





W'S™



TECNICALGEAR SYSTEM™



MULTISEASON SYSTEM™

Unpredictable and bizarre,
agile and colourful.
Enhance your style, for the
world is yours.

A perfect day.

A perfect you.

Accessories and extras designed to ensure
performance, protection and comfort
whatever the conditions.

Applied research to guarantee that
your body stays dry even in the most
extreme situations.

The Service Center is the reference point for all Campagnolo® dealers and its aim is to provide an adequate after-sales service to Campagnolo® users. Service Centers are a territorial extension of Campagnolo srl and work exclusively with dealers, no exceptions made.

The Service Centers handle two activities: After-sales Service and Spare Parts Service.

The After-sales Service provides technical assistance for products under guarantee or otherwise, enabling cyclists to enjoy the first-class characteristics of Campagnolo® products for long, without forfeiting safety, performance and endurance.

The Spare Parts Service handles the distribution of spare parts. Campagnolo® possesses a large inventory of spare parts and is able to replenish its distribution

system adequately in relatively short times. We therefore advise you to refer to your Campagnolo® dealer for any expert action required by your bikes - these dealers are the only ones supported by the constant, skilled collaboration of Campagnolo® Service Centers.

ITALY - Central Service Center

CAMPAGNOLO SRL HEADQUARTERS
Via della Chimica, 4 - 36100 VICENZA
Tel. +39-0444-225605
Fax +39-0444-225606
E-mail: service@campagnolo.com

AUSTRALIA

CYCLING PROJECTS
Shop 1 - 86 King Street
NSW 2193 Ashbury
Tel. +61-2-97992407
Fax +61-2-97992107

AUSTRIA - GERMANY

CAMPAGNOLO DEUTSCHLAND GMBH
Alte Garten 62
51371 LEVERKUSEN
Tel. +49-214-206953-20
Fax +49-214-206953-15

BENELUX

INTERNATIONAL CYCLE CONNECTION I.C.C.
Handelspoort, 3A
4538 BN TERNEUZEN
Netherlands
Tel. +31-115-649321
Fax +31-115-649110

CANADA

CYCLES MARINONI INC
1067, Levis - LACHENAIE
QUEBEC J6W 4L2
Tel. +1-450-4717133
Fax +1-450-4719887

GREAT WESTERN BICYCLE CO. LTD.
232 West 7th Ave.
VANCOUVER, BC V5Y 1M1
Tel. +1-604-8722424
Fax +1-604-8720226

CZECH REPUBLIC

KOLA SIRER
V Plzenske Brane 1
26601 BEROUN
Tel. 00420 311 621355
Fax 00420 311 625492

DENMARK - FINLAND - NORWAY - SWEDEN

MARKER SCANDINAVIA
Ledreborg Alle 10 - DK-4320 Lejre
DENMARK
Tel. +45-70228075
Fax +45-46498088

FRANCE

CAMPAGNOLO FRANCE EURL
ZA du Tissot
42530 St Genest - Lerpt
Tel. +33-477-556305
Fax +33-477-556345

GREECE

CYCLES FIDUSA - GIORGIO VOYATZIS & CO.
Th. Sofuli 97
85100 Rhodos
Tel. +30-2241 021264
Fax +30-2241 021519

ISRAEL

AMIT LEVINSON LTD
25 Sheshet Hayamim Str. - Qiryat Haim
POB 252 ZIP 26101
Tel. +972-4-8405649
Fax +972-4-8423913

JAPAN

CAMPAGNOLO JAPAN LTD
65 Yoshida-cho, Naka-ku, Yokohama
231-0041 JAPAN
Phone: +81-45-264-2780
Fax: +81-45-241-8030

KOREA

COMET BICYCLE ASSOCIATION
B1. 1015-3 Sinjungdong
Yangchungu, SEOUL Tel. +82-2-26421764
Fax +82-2-26421765

NEW ZEALAND

WH WORRALL CO. LTD.
43 Felix St./Penrose - P.O. Box 12481
Auckland
Tel. +64-9-6360641
Fax +64-9-6360631

SINGAPORE

TRIMEN VENTURES PTE LTD
705 Sims Drive
#01-16 Shun Li Industrial Complex
Singapore 387384
Tel: +65 6354 3030
Fax: +65 6354 3020

SPAIN

CAMPAGNOLO IBERICA S.L.
Avda. de Los Huetos 46 Pab. 31
01010 VITORIA
Tel. +34-945-217195
Fax +34-945-217198

SLOVAC REPUBLIC

ZANZO S.R.O.
Kysucky Lieskovec 421
02334 BRATISLAVA
Tel. 00421 245 523721
Fax 00421 245 249404

SOUTH AFRICA

CYCLING J&J (PTY) LTD.
169 Meerlust Street - Willow Glen PRETORIA
Tel. +27-012-8075570
Fax +27-012-8074267

SWITZERLAND

SWISSBIKE PIERO ZURINO GMBH
Pilatusstr. 4 - 6036 Dierikon
Tel. +41-41-7485550
Fax +41-41-7485551

U.G.D. SPORT DIFFUSION S.A.

La Taille - 2053 CERNIER
Tel. +41-32-8536363
Fax +41-32-8536464

UNITED KINGDOM

ITALIAN CYCLE PRODUCTS LIMITED
Unit 3, Napoleon Business Park
Wheterby Road - DERBY - DE24 8HL
Tel. +44-01332-371176
Fax +44-01332-371179

UNITED STATES

CAMPAGNOLO NORTH AMERICA INC.
5431 Avenida Encinas, Suite C
CARLSBAD CA 92008
Tel. +1-760-9310106
Fax +1-760-9310991

OCHSNER INT. INC

246 E. Marquardt Drive - WHEELING
IL. 60090-6430
Tel. +1-847-4658200
Fax +1-847-4658282

QUALITY BIC. PRODUCTS

6400 W. 105th Street
BLOOMINGTON, MN 55438-2554
Tel. +1-952-9419391
Fax +1-952-9419799

THE HAWLEY COMPANY, INC.

1181 South Lake Drive
Lexington, SC 29073-7744
Tel. +1-803.359.3492 x 192
Fax +1-803.359.1343

Agencies:

ITALY

CAMPAGNOLO S.R.L.
Via della Chimica, 4
36100 Vicenza - ITALY
Phone: +39-0444-225500
Fax: +39-0444-225400

FRANCE

CAMPAGNOLO FRANCE EURL
ZA du Tissot - 42530 St Genest - Lerpt
FRANCE
Phone: +33-477-556305
Fax: +33-477-556345

GERMANY

CAMPAGNOLO DEUTSCHLAND GMBH
Alte Garten 62
51371 Leverkusen - GERMANY
Phone: +49-214-206953-0
Fax: +49-214-206953-15

JAPAN

CAMPAGNOLO JAPAN LTD
65 Yoshida-cho, Naka-ku, Yokohama
231-0041 JAPAN
Phone: +81-45-264-2780
Fax: +81-45-241-8030

SPAIN

CAMPAGNOLO IBERICA S.L.
Avda. de Los Huetos 46. pab. 3-2ª fila
01010 Vitoria - SPAIN
Phone: +34-945-217195
Fax: +34-945-217198

UNITED STATES

CAMPAGNOLO NORTH AMERICA INC.
5431 Avenida Encinas, Suite C -
CARLSBAD CA 92008 - U.S.A.
Phone: +1-760-9310106
Fax: +1-760-9310991

AUSTRALIA

CYCLING PROJECTS
Shop 1 - 86 King Street
NSW 2193 Ashbury - AUSTRALIA
Tel. +61-2-97992407
Fax +61-2-97992107

BENELUX

INTERNATIONAL
CYCLE CONNECTION I.C.C.
Handelspoort 3A
4538 BN Terneuzen
NEDERLAND
Tel. + 31 (0)115 649321
Fax + 31 (0)115 649110

EAST EUROPE

FIRMA GALLIZIA
10. Oktoberstrasse 7 - 9800
Spittal/Drau AUSTRIA
Tel. +43-4762/2275
Fax +43-4762/2275

DENMARK - SWEDEN - NORWAY- FINLAND

MARKER SCANDINAVIA
Ledreborg Alle 10 - DK-4320 Lejre
DENMARK
Tel. +45-70228075
Fax +45-46498088

SOUTH AMERICA AND MEXICO

GEORGE PANARA
Sao Paulo - BRASIL
Tel.: +55 11 4436 9123
Fax: +55 11 4436 12 13

TAIWAN, MAINLAND CHINA, VIETNAM

COLMAX INTERNATIONAL LTD
No. 42, Alley 30, Lane 300
Section 2, Jhong Hwa S. Road
Tainan 702, TAIWAN
Tel. +886-6-265 6001
Fax +886-6-265 1388

UNITED KINGDOM

SELECT CYCLE COMPONENTS
The White House
Main Street
NEWTON NI13 8HN - ENGLAND
Tel. +44-0780260628
Fax +44-1949-829039

Service and technical information:

ITALY (CENTRAL)

Technical Information
Phone: +39-0444-225600
Fax: +39-0444-225400
Service Center
Phone: +39-0444-225605
Fax: +39-0444-225606

FRANCE

Phone: +33-477-554449
Fax: +33-477-556345

GERMANY

Phone: +49-214-206953-20
Fax: +49-214-206953-15

SPAIN

Phone: +34-945-217195
Fax: +34-945-217198

U.S.A.

Phone: +1-760-9310106
Fax: +1-760-9310991

CAMPAGNOLO S.R.L.
 Via della Chimica, 4
 36100 Vicenza
 ITALY
 Phone: +39 0444 225500
 Fax: +39 0444 225400
 www.campagnolo.com

Printed in Italy 08/2007

Dear Friend,

We have tried to be precise but would like to apologize for any mistakes that there might be in this catalogue. We must also point out that we reserve the right to change products, surface finish and specifications at any moment without prior notice. For further information, please visit our site **www.campagnolo.com**, which is regularly updated.

Campagnolo®, Campy™, Record™, Chorus™, EPS™, CT™, Centaur™, Veloce™, Mirage™, Xenon™, Hyperon™, Neutron™, Proton™, Eurus™, Zonda™, Scirocco™, Vento™, Bora™, Ghibli™, Pista™, Khamsin™, Shamal™, Time Trial™, Ergobrain™, Symmetric Action™, Z-shape™, M-brace™, Even-O™, Superlative™, Floating-Link-Action™, HD-Link™, HD-L™, Exa-Drive™, Ultra-Drive™, Pro-Fit™, Pro-Fit PLUS™, Differential brakes™, Threadless™, Hiddenset™, Hiddenset TTC™, TTC™, Ergopower™, BB System™, C10™, C9™, ED™, UD™, Ultra Narrow™, Ultra-Torque™, UT™, Ultra-Hollow™, Skeleton™, Quick Shift™, QS™, Escape Infinite™, Champ Triple™, Race Triple™, Comp Triple™, HPW™, G3™, Grouped Spokes™, DPRO™, Dual Profile™, Ultralinear-Geometry™, Ultralinear™, Differential rims™, Differential spokes™, Asymmetric™, Ultra™, Ultra Aero™, Full Carbon™, Multidirectional™, Unidirectional™, AC-H™, AC-S™, SC-S™, Big™, Miro™, Pro-Shop™, Tecnologia ed Emozione™, are Campagnolo Srl Trademarks.

