

Rivendell Bicycle Works

Catalogue & Price List
No. 5



SUMMER 1999 – WINTER 1999

Policies & Practices

GUARANTEE

We sell only things we use ourselves and know to be good, and we've tried to be accurate and thorough with the descriptions. That's so you know as much as possible before you buy.

RETURNS

If it has a hole in it or a missing piece, or the color isn't what you thought it was, or it looks better in the catalogue than it does in real life, or you lose your job between the time you ordered it and the time you got it, or for any reason you want to return something, fill out the return form included in each order. You pay the return postage (job or no). You have six months to return it for a real-money refund; and up to a year for credit.

Allow 10 days for exchanges. It's all explained on the return form.

FAIR-TO-ALL-PRICING

We pay the same prices you do, and we don't have "pro" deals to industry employees or "bro" deals to friends and family. Also, we don't participate in Hollywood product placement deals, so rest assured your purchases are not subsidizing the elite. So far as we know, nobody famous rides a Rivendell, although one guy is borderline. If anybody famous ever does get one, you won't hear it from us! (Unless it's _____.)

MONEY-GIVING

Our sole charity is the Bicycle Inter-Community Action and Salvage (BICAS). Former Bridgestone covergirl and good friend Kim Young teaches bike mechanics and functional bicycle industrial sculpture and art to local, at-risk boys and girls. They sell the refurbished bikes cheap to locals, or in central America. Besides that, BICAS also makes bike racks, garbage receptacles, picture frames, and lamps. BICAS is a good cause, and we give them about \$1,000 a year.



• Rivendell Bicycle Works •



WE'RE A FIVE-YEAR-OLD MAIL-ORDER BIKE SHOP for bike riders who prefer traditional, classical bicycles and parts and accessories to today's ever-changing, high-tech fare. Sometimes people hear "classical" or "traditional" in the context of bicycles, and think turn-of-the-century highwheelers or '50s ballooners, or English three-speeds, or restoring vintage racing bicycles. Those are good pursuits, but they're not our deal. We just like to ride bikes, and are more influenced by the pure, practical, and beautiful design ethics of the '70s to late '80s.

Then, the cycling powers in Japan and Europe were mature, and hadn't yet been corrupted by power, and were not yet influenced by the need to radically change technology every couple of years in order to increase sales in a flat market. There was variety and healthy competition, and the best of the new designs were refinements of already excellent ones. We took it for granted at the time, but have come to appreciate it now.

We offer gear for cyclists who can't relate to the aggressive, thrill-seeking and/or body-shaping approach that passes as normal today. Our bikes are designed and built to withstand a lifetime of long, hard, fast riding and racing, if that's what you're up to, but we don't go out of our way to appeal to the rambunctious, speed-before-all crowd. It isn't *us versus them*, or *retro versus techno*, or *old versus new*. It isn't niche marketing in the tactical sense, either. It's the same gear we prefer, and ride, every day. It is not a "market-driven" approach, which is one reason we're so small.

As you look through this catalogue, you'll see a common theme. It is simple gear, because bikes aren't improved by complication, and simple parts allow for more rider input. It is practical gear, in the sense that it fulfills a fundamental cycling (not just psychological) need. And it is proven—much of what we offer was born before we were, and even new items borrow heavily from materials and designs from the past. On the other hand, when something new comes along that really is better, or has something practical to offer, it stands a good chance.

We believe the best bicycles are simple to operate, simple to fix, and simple to understand. They aren't black box point-and-pedal bikes. Those kinds of bikes are important, and get a lot of people into this sport, and for some people, they're the best choice. But just as a point-and-shoot camera leapfrogs the full photography experience on the way to getting you the snapshot, we believe part of the fun of riding a bike is interacting with it. That's why we like bikes that allow human input—*manual* bicycles. Compared to the point-and-pedals, they're at least as fun to ride, easier to service, less likely to need service, and more satisfying to use. For anybody.

Also in here, you'll find leather saddles, wool clothing, waxed cotton saddlebags and panniers, standard pedals clips and straps, assorted curved handlebars, chains and freewheels, forged aluminum cranks, sidepull and cantilever brakes, friction shifters, and cotton handlebar tape. As technology goes, we don't consider it outdated, but refined, and in some cases, perfected. We have all you need to build and equip your bike, but there's no gratuitous high-tech, and our selection is narrow. Every item earned its spot by being the best, the best value, or the last of its kind available. And, if we sell it, we also use it, know its quirks, believe in it completely, and can tell you anything you want or need to know about it. Ask away!

We've survived because we don't depend on local business. The web helps. We spend what money we make on lug tooling, inventory, and publishing this catalogue and the Reader. We don't actually have a promotional budget, so if you know others who might like our catalogue, please tell them about us or us about them. If you know any bike clubs that might like this catalogue, please drop us a line. If you're attending a cycling event and are willing to pass out catalogues, we'd be so grateful. Keep this catalogue! But if you lose it, ask for another and we'll mail it right out.

—Grant, Peter, Joe, Allen, and Mary

Table of Contents

| | |
|---------------------------------------|----|
| JOIN RIVENDELL? | 3 |
| RIVENDELL BICYCLE FRAMES | 4 |
| POSITION IS EVERYTHING | 15 |
| STEM FITTING NOTES | 17 |
| FRAME ORDER FORM | 19 |
| BAGGAGE | 20 |
| RACKS AND MOUNTS | 28 |
| HANDLEBARS | 30 |
| HANDLEBARS EXTRAS | 37 |
| STEMS | 39 |
| SADDLES & ACCESSORIES | 46 |
| SEAT POSTS | 50 |
| GEAR SHIFTING & SHIFTERS | 51 |
| FRONT DERAILLEURS | 58 |
| REAR DERAILLEURS | 59 |
| CHAINRINGS & GEARING | 61 |
| CRANKS | 63 |
| BOTTOM BRACKETS | 64 |
| PEDALS, CLIPS, & STRAPS | 66 |
| SHOES | 67 |
| BRAKES | 68 |
| HUBS & WHEELS | 72 |
| RIMS | 74 |
| TIRES | 75 |
| SUNDRIES & SUBSTANCES | 69 |
| TOOLS | 78 |
| SAFETY STUFF | 81 |
| CLOTHING | 82 |
| SOAPS | 87 |
| BOOKS & POSTERS | 88 |
| MEET THE STAFF | 90 |
| RIVENDELL HOURS & VISITING TIPS | 92 |
| MERCHANDISE ORDER FORM | 93 |
| MEET THE STAFF | 94 |

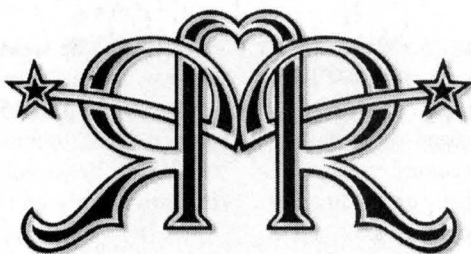

How and Why To Join/Subscribe

A "MEMBER" AND A "SUBSCRIBER" ARE THE SAME THING,
AND ALL IT MEANS IS THAT WHEN YOU PAY \$15,
YOU "BECOME A MEMBER" AND GET:

☞ **Four issues the Rivendell Reader.** It's 40 pages long, mostly about bicycles, and covers topics most of the real bike magazines don't. Technical, casual, interesting, unusual, some history, interviews, but nothing on travel, stretching, cross-training, diet, recipes, or hero worship.

☞ **Member prices** on everything we offer. On sub-\$10 items, you'll save a dollar or two; on \$50 to \$100 items, it's usually \$4 to \$9.

☞ **Rivendollars.** Each issue of the Reader has three or four Rivendollars, cumulatively worth around \$25 toward qualified purchases, and since your \$15

gets you four issues, simple math makes a good case for joining.

☞ **Special mailings** listing parts we got in too late to fit into the catalogue, or things we don't have enough of to put into the catalogue.

REVIEW

For \$15/\$22 Foreign, you get

- 4 issues of the Rivendell Reader
- \$80 to \$90 Rivendollars
- access to good, hard to find parts
- Member prices on all we offer.

You can join/subscribe by phone, fax, or online: www.rivendellbicycles.com

| | | |
|--|-----------|-----------|
| Name _____ | | |
| Address _____ | | |
| City _____ | St. _____ | Zip _____ |
| Master or Visa # _____ | Exp _____ | |
| Day Phone _____ | | |
| If you live in California, which county? _____ | | |

Rivendell Bicycle Frames



FOR THE PAST 5 YEARS lugged steel bicycle frames have been getting increasingly scarce, victims of manufacturing economics and a shortage of builders with good brazing skills. Now lugged steel frames are a small minority, and new cyclists don't give them a second thought.

What a change from just 18 years ago! And all the years before. Back then, Reynolds and Columbus steel tubing was the material of choice, lugs were a given on all but the cheapest frames, and joining one tube directly to another by melting them both (TIG-welding) was regarded as cheap way to build a frame, and bike shops wouldn't sell them. We know now that TIG-welding is reliable, and it is unquestionably the most economical way to bring high performance bicycles to the largest number of cyclists.

The first TIG-welded frame to make it into a bike shop was the Stumpjumper. That was 1981 or so, and people were so hot for an affordable mountain bike that they

overlooked the welds and bought them up anyway. More TIG-welded frames followed, and over the past 15 years, tig welding has proven itself to be a reliable way to join tubes, and has totally taken over. That's the modern history of TIG-welding.

Now it's 1999, and even the most revered names from Europe and many in the United States—makers who built their

reputation on lugged steel—are now offering frames that fly in the face of the style that won them that reputation. It used to mean something to say "I have a Colnago" or "My bike's a Tomasini" (or Masi, or DeRosa). These days that doesn't even identify the material. Forks crowns have disappeared, fork blades are straight, steel frames

get aluminum forks, tube dimensions are overmanipulated, and many expensive frames look like they take longer to paint than to build. In most of the hallowed frame shops in Europe, the founders have burned out, sold out, or undergone a late-life crisis, and a business that once had conviction and passion is now controlled by new blood and ideas that kow-tow to market trends at the cost of its heritage.

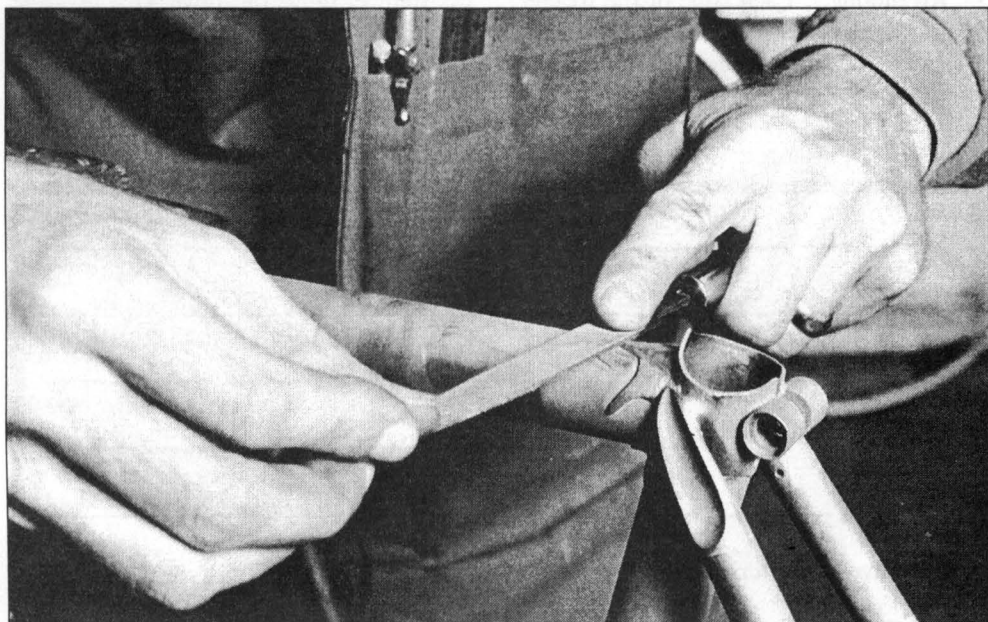

Curt Goodrich thins a lug.

They call all change "progress," but the traditional materials, methods, and design elements that defined them have been lost to the urgency of building bikes fast and cheaper, often under the banner of "high tech."

People look at Rivendells, focus on the lugs and fork crowns, and instantly dub them "retro." But they aren't "retro." Retro is style for nostalgia's sake, like cork-topped metal water bottles, wooden rims, and Cinelli M-71 pedals. There's nothing wrong with that in its own context, but we make bicycles for riders. The details that look "retro" just happen to be strong, attractive, and practical—just as they were way back. Our lugs hog a lot of attention, and are sure to be too fancy for some. But all the fanciness came after the important details were in place—the broad spoons in the stressed areas, the elimination of stress risers, the extensions that allow you to get the handlebars into a higher, more comfortable zone without resorting to extreme measures. They're smart before they're fancy.

"It's the most beautiful thing I've ever seen. Wherever I take it, people pause and drool. Riding it is a dream. It embraces the road."

*Rachel S., California,
52cm Road*

A Rivendell frame and fork, painted and prepped (all threads cleaned and the head tube and bottom bracket shell squared) takes from 3 to 8 months to get, and, costs \$1,500 to \$1,575, depending on the model. The frame will weigh 4 1/4 to 5 1/2 pounds, and the fork, 1 1/4 to 2 pounds. It costs \$1,200 to \$1,600 to buy all the parts to make a complete Rivendell bicycle, which will weigh 20

1/2 to 25 1/4 pounds and cost a little less or a little more than \$3,000.

You can go to a good local bike shop tomorrow and walk out with a bike that weighs less, shifts and brakes faster, and costs half as much. That's why those bikes outsell Rivendells 3,000 to 1. But if bikes are more to you than an exercise tool—if you like practical, well-thought out design, tradition, craftsmanship, and the idea of riding the best bicycle it is humanly possible to make, and growing old with it while new trends come and go, then a Rivendell frame is a good start, and a bargain, too.

The following pages tell you why.

—Grant, Peter, Joe, and Allen

HISTORY & DURABILITY

Pro racers may ride faster and more miles than you, but they spread those miles over several frames, and they don't weigh as much as you do, and they ride a frame for a season or two, and then get new ones. Modern pros get new ones every season, and often have several. We heard one story of a racer getting 14 frames per season, every season, and a new one before every particularly bumpy-road race. True, a racer rides 20,000 miles in a season. But if you ride 4,000 miles a year, that's still only 5 years worth; and you may weigh more than a typical 152 lb racer does, and may not be quite as smooth on the bike. So during the next decade or score, you will stress a frame as much or more than a racer does, simply because you weigh more and will ride it longer, with a jerkier style. You need a better bike.

We realize you expect your frame to last for the rest of your life, so we're extra careful when we design your frame, pick the tubes, and choose the builder. In addition, if your frame says Rivendell, you can trust it to last a long, long time.

DESIGN VALUES

CLEARANCE—FOR VERSATILITY

During the past seven years, road bikes have devolved into one-trick ponies, at home only on smooth, dry asphalt, while carrying minimal provisions. They're designed for cyclists with cell phones and sag wagons. But the odd thing is, the features that make a bike more versatile, more able to handle the real world, don't slow you down at all. Quite the contrary! Good clearance can let you ride a wobbly wheel that won't pass through a frame with insufficient clearance.

Road bike versatility is largely a matter of **TIRE CLEARANCE**—the amount of air between your tires and the frame.

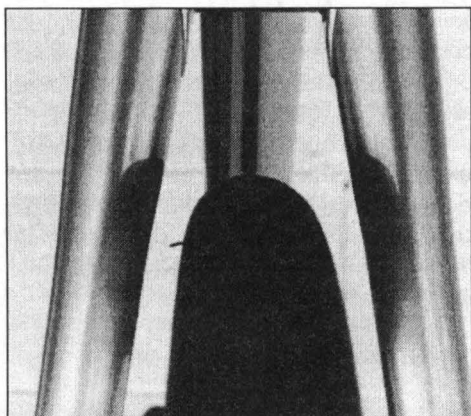

AN AVOCET 700x32 PASSES BETWEEN OUR ROAD FRAME'S CHAINSTAYS WITH ROOM TO SPARE. IF YOU BREAK A SPOKE, IT WILL STILL CLEAR.

It's an issue in two places.

1. BETWEEN THE CHAINSTAYS

Many frames are so cramped here that the largest tire you can fit in them is a 700x25—and if you break a spoke or bend your rear wheel (something that's more likely on a hard, skinny tire), the tire will rub on the chainstay every time the wobbly part passes by. You could rub a hole right through a carbon fiber chainstay. Our standard road frame accepts tires up to 700x35; our LongLow, up to 700x38; and our All-Rounder, up to 26x2.2.

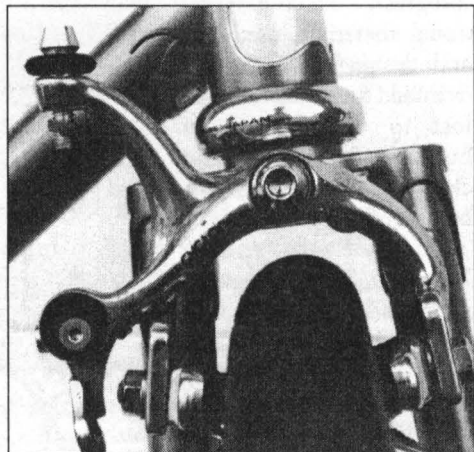

OUR ROAD FRAME WITH A 700x32. THERE'S ROOM FOR FENDERS, AND WITHOUT FENDERS, IT FITS UP TO A 700x35.

2. UNDER THE BRAKES

Clearance here allows you to ride fatter tires and mount fenders. And we mean full fenders, not the short clip-ons that look bad and work as well as half an umbrella. Riding on wet roads gets you and your bike filthy, and sprays water and road on whoever's behind you. A bike that fits fenders is a year-round, all-weather bike.

WHAT YOU SHOULD KNOW ABOUT BRAKE REACH

It is the distance from the center of the mounting bolt to the center of the brake pad when the brake is at the top of the slot and the bottom of the slot. Sidepull brakes can be divided into two categories: short reach and standard reach. Short reach brakes have minimum and maximum

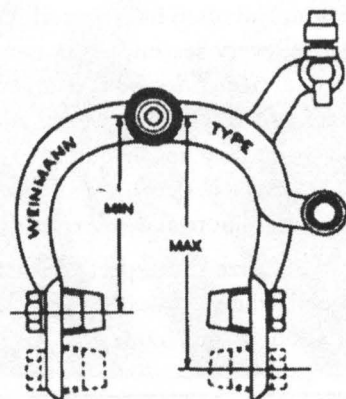

reaches of about 39mm and 49mm respectively; standard reach brakes are 47 to 57mm.

Through the '80s, good sidepulls were made in both short reach and standard reach. Standard reach brakes were designed for year-round, all-purpose riding, with a variety of tires, which is why they were standard. Short reach brakes were for smooth-course criterium racing, with skinny tires. If you had short reach brakes with minimal clearance, it was a sign that you were a criterium specialist, or wanted to look like one.

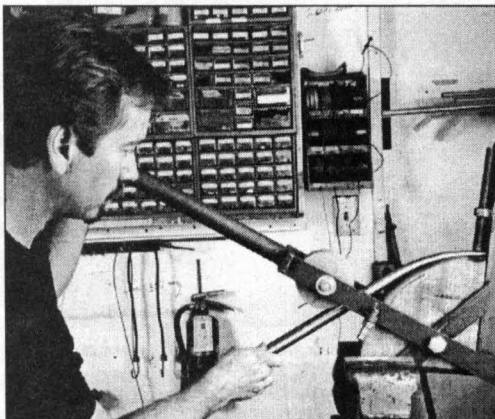

Joe bending a fork blade over a custom-made maple block

Short reach brakes have no practical advantage over standard reach brakes. They've taken over largely because fashion is powerful, and the people who were in a position to keep standard reach standard, didn't do it.

For a frame to fit both short reach brakes and fenders or fat tires, the fork length and position of the rear brake bridge have to be such that the brake shoes are within a millimeter of the bottom of the slot when the brake shoes are contacting the rim. Most makers use a production-friendly mid-slot spec, which better tolerates inconsistent blade lengths and bridge heights. They get away with it because it's the norm.

DUAL PIVOT BRAKES AND CLEARANCE

On these brakes, the underside of the caliper arms crowds the fender. Shimano brakes are better in this regard than Campy (some models of which totally rule out fenders), but no dual pivot offers the clearance of a typical, garden variety, single-pivot sidepull. The only dual-pivot with bountiful clearance is Shimano's RX100, in standard reach; and then, only if the brake pads are down near the bottom of the slots.

DURABILITY

During the past twenty-five years we've seen hundreds of top-quality, famous frames cracked, buckled, and broken. These frames weren't bad; they just lived hard lives and finally died. On Rivendell frames, we guard against failures with a combination of more and stronger metal in the danger areas, and low-stress design, and careful material handling and brazing.

- A COMMON BREAK is at the right chainstay, behind the bottom bracket. To reduce stress here, we file off the right-side point of the bottom bracket shell, so it doesn't act like a can-opener.

Our chainstays, like

all the other tubes in our frames, are made from the strongest, most fatigue-resistant steels. The walls vary in thickness from 0.8mm to 1.0mm, and we often use a heavier right chainstay. Perfect brazing ensures a strong, long-life joint.

- Sometimes the underside of down tube buckles or cracks behind the headset. It won't buckle unless you run into something, which doesn't count; but even so, a thicker wall and a longer butt will fend off a blow that'll buckle a short-butted, thin-walled downtube. Cracks here are almost always caused by points in the wrong part of the lug. We've eliminated that possibility, with a large, stress-eliminating radius on the lower head lug.

- ANOTHER PLACE FRAMES BREAK is at the base of the seat tube, just above the bottom bracket. So our lower seat tube butts vary from 0.8mm to 1.0mm, depending on your weight, your frame size, and how you ride. For bottom bracket shells, we use the best investment cast models, modify them as we see fit, then skillfully braze the joint.

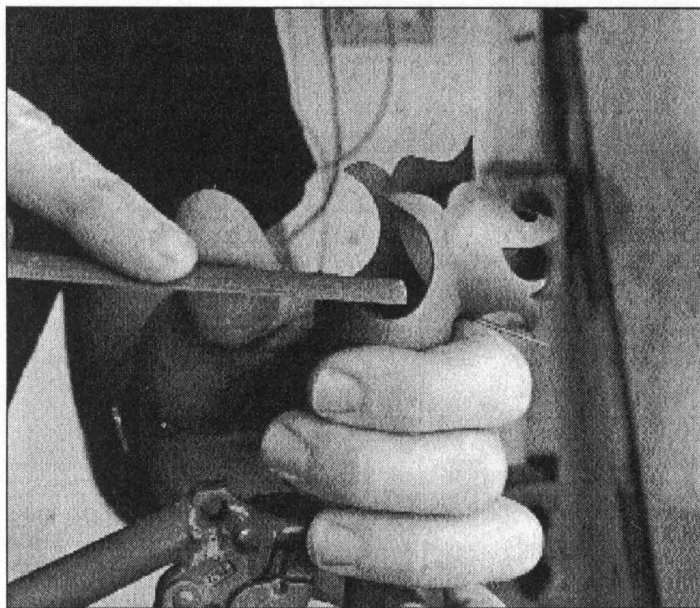

Joe prepares a lug. The lugs are pretty clean to begin with, but filework is still a part of building a fine, traditional frame.

• **THE MOST COMMON BREAK** is the right rear dropout. Most failures here are from riding broken or bent rear axles, and you can prevent it by riding hubs with axles that don't bend or break, such as Phil or Bullseye, or by riding cassettes.

Dropouts vary a huge amount in design and materials. We use forged carbon steel dropouts from Tecnociclo in Italy. Special models made for us, with good, sound designs. They probably won't break.

MANY OF TODAY'S more expensive frames, are "transitional"—something to ride until the next technological or marketing breakthrough persuades you to get another. We design and build your Rivendell to be the last bike you'll ever need. We use the best materials, joint design, and joinery, because our goal is a frame that plain won't break.

POSITION, SIZING, FIT

These three things are more important than everything else combined.

Many rider/geometry chart readers get bogged down with top tube length. There is widespread misunderstanding about the top tube's influence on fit. Differences in seat

tube angle, top tube slope (if any) and handlebar height are all at least as influential as the actual measured length of the top tube, and a 58cm top tube on one bike might feel shorter than a 56cm one on another. And, in the case of Rivendells, the listed top tube dimension is on a theoretical horizontal line to the center of the head tube. When you get your frame and measure the actual top tube, it won't be as listed.

Confused? Well, don't worry about the top tube length. Tell us your overall height, pubic bone height both in bare

feet and in your cycling shoes, and your saddle height, (center of bottom bracket to top of saddle), and we'll fit you right.

ALL FITTERS AND SCIENTIFIC SIZING SYSTEMS HAVE THEIR BIAS. OURS IS COMFORT. We want you to be more comfortable, right off the bat, than you've every been on a bike before. It's easy to do.

Comfort comes from supporting weight on your butt, as opposed to your arms and hands, and not bending over too far. Our frames encourage this with shallow seat tube angles (which shift weight onto your butt) and taller head tubes (which take weight off your hands by allowing a higher handlebar). On midsized frames, we like the bars within a centimeter of the top of the saddle. On smaller frames, get it even; on 63cm and larger, within 4cm.

It starts with the proper frame size, and in the case of a Rivendell frame, that will probably be larger than the frame you're riding now. But our frames have several easy-to-overlook design details that make them fit differently than other frames fit

In some cases, young and flexible and feather-weight riders can ride smaller frames (with resulting lower bars) than can older and stiffer and heavier riders. We always talk the size over with you, and are happy to answer any of your questions about it. We know how our bikes fit—take advantage of that and let us help you pick your size!

"The bike fits me perfectly and riding it is the most fun I've had on a bicycle. Many people have said, and I feel as well, "That is the most beautiful bike I've ever seen."

*Sally M., Tennessee,
50cm All-Rounder*

you set up for the turn (by countersteering) a little later than a bike that doesn't.

Some bikes oversteer—you start the lean and they go too far, so you collect your wits and get the bike back on course. Some bikes understeer, which is what you feel when you're leaning the bike and looking at your path, but the bike seems to not turn as tight as the corner requires. Bikes with high bottom brackets tend to feel like those punch-

ing-bag clowns. You can lean them, but they much prefer being straight up, and that makes turning hard.

THE RIGHT SIZE STEM

If you ride a 52cm frame and show eight inches of seat post, and need a 12cm stem, or if you're on a 63cm frame with three inches of post and you need an 8cm stem, something's wrong. The following guide will hone you in close enough so that a perfect fit should be only one stem-switch away.

| frame size | stem length w/drop h'bars | stem with Moustache H'bar |
|------------|------------------------------|------------------------------|
| 50 to 52 | 8 to 10 | 7 to 8 |
| 53 to 55 | 8 to 11 | 7 to 9 |
| 56 to 59 | 9 to 12 | 8 to 9 |
| 60 to 63 | 11 to 12 | 9 to 10 |
| 64 to 65 | 11 to 13 | 10 to 11 |

RIDE QUALITY

How your bike feels depends on its geometry, size and set-up, your weight distribution, and what you're used to.

We like bikes that go around turns well, and are easy to control on rough surfaces and in wind. That's like saying "we like our food delicious and nutritious," but many highly regarded bicycles fall short in these categories. All Rivendell bikes lean over with light, consistent resistance. That means you can speed down a twisty mountain road, and make the transitions from leaning left to leaning right, safely, with predictability and control. Just as important but more demanding of the bike (and you) is the sharp, high speed turn that comes unexpectedly. In a situation such as this, no bike can overcome bad preparation or technique, but a bike that tilts easy will help

FRAME WEIGHT

Our lightest 52cm road frames, built for 120lb riders, weigh 4lbs. 2 oz. A stout road frame for a big stout guy will weigh between 4.5 and 4.9lb. LongLows weigh about 3 ounces more than Roads, and All-Rounders, about 4 ounces more still.

THE UNIMPORTANCE OF FRAME WEIGHT

That bicycle frame weight is overemphasized becomes clear when you consider the difference between a superlight frame and a normal one is about a pound and an eighth, maybe a pound and a quarter. Calling one frame "30 percent lighter" than another frame sounds impressive until you realize that with 17.5lb of parts on it and a 170lb rider in the saddle, the difference is half to three-quarters of one percent. When you consider handling and longevity, a little more material in the places frames are known to fail begins to make sense.

APPEARANCE

We like bike frames to look low-key from a distance and interesting up close; and if you build it up right, it'll look like a gentle farm horse, as opposed to a sneering hood or a mean, futuristic robot. We also want Rivendell frames to be recognizable, even stripped of paint, and so we use our own, unmistakable lugs. Aesthetically, they split the difference between Italian plain and English Fancy, and have French-style

spoons and the undersides of the tubes. Both our fork crowns are flat, investment cast, and look good. The frames have minimal decaling, and simple but nice paint jobs (with creamy head tubes and matching lug windows). Color catalogues cost too much, so see them on the web at www.rivendellbicycles.com.



After Joe bends the blades, he dons shades, then brazes up a fork

Are you getting the tubing you think you're getting? Do you know if any of the tubes were reversed? It's not unheard of. What about material preparation? A dirty tube can't be brazed well, but you won't find

out right away. In any case, meticulous prepaint frame preparation, and a top paint job done in your current favorite color, can mask a lot.

QUALITY

THE BEST WAY to determine a frame's quality is to check its alignment, and then have it analyzed by stress photronics, strain gauges, or finite element analysis. Next, test each joint to make sure the tube fails before the joint, and after that, cut the joints in half and look at the miters.

Then send the frame out for metallurgical analysis to determine the size, location, and severity of the molecular changes in the metal resulting from heat. If by then you're comfortable with the quality, ask the builder for another exactly like it—and this one you'll pay for.

WAY NUMBER TWO is to look into the bottom bracket shell to see if the tubes are mitered. But what then—do you assume the invisible joints are done the same way?

QUALITY AND GUARANTEES

A manufacturer uses Lifetime Guarantees 1) As a sales tool when there's no other compelling reason to buy a bike; 2) As ammo for a technically undereducated sales staff; 3) When pressured by dealers who are competing with other lines that offer them; and 4) When there's so much profit built into the pricing that it's a financial and marketing no-brainer.

We believe Rivendells are the best frames in the world, and we guarantee that we don't cut any corners in their design or manufacture. We believe they are less likely to break than any other lightweight frame made today. It is extremely unlikely that your frame will break, because we design and build them to last.

"Such a comfortable ride —OY! I was seriously skeptical about whether I'd be sensitive enough to really notice a difference... I noticed a HUGE/VAST difference. This thing cruises so easily, but the handling on fast descents was really the revelation. I rode a couple of downhills that I've whiteknuckled on my _____, but on the Riv I had to keep wondering when the hairy parts were gonna start ...then it was over. No drama, just smooth, easy to lean, easy to carry speed through the turns. Never touched the brakes in places where I used to live on them!"

Ray S. Connecticut, 58cm Road:

ROAD STANDARD

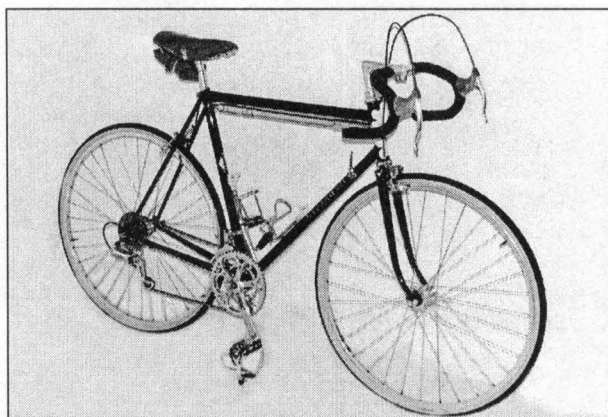

Member # 1413's Road Standard

This is a classical road frame improved with the best modern materials, and thought-out design refinements. It is classical, in the sense that it borrows the best elements of the road frames of the '70s and '80s—namely, a lower bottom bracket, longer chainstays, good tire clearance, and a lugged, steel frame and a fork with a real crown. Ride it around other cyclists, and they'll ask "how old is that?" and "where'd you get it?" It doesn't look modern; it looks gentle.

Some refinements that make it different are:

1. A 1.5-degree upsloping top tube, a 15mm head tube extension, and a 10mm longer steer tube that, combined, allow you to get the bars about 4.5cm higher than you can with a regular old road frame, and until someone copies it, is unique to Rivendells. That means less stress on your neck and hands and lower back, and consequently a more comfortable ride.

2. It's designed for modern sidepulls, yet it accommodates tires up to a 700x35. That means you can ride rougher roads without damaging your wheels, and any ride can be more comfortable.

3. It has eyelets for fenders.

We use the best and most appropriate seamless, fine-grained, ductile-as-opposed-to-brittle, steel tubing from Columbus (Nivacrome) and Dedacciai of Italy (mcdv6, a vanadium-improved steel alloy), Vitus of France (the same mcdv6 as Dedacciai), and Reynolds of England (custom 753 and 725, 853, and 531 fork blades). Each of these makers has made tubes to our specifications when the standard tubes weren't right. Usually that means they weren't thick enough in the right places. (It may interest you to know that some of today's best bicycle steel alloys were inspired by the need to withstand the extreme heat of TIG-welding; and the butting patterns were designed to shave every last gram, so a steel frame could approach the weight of an aluminum one.)

Our Road frame customers range from new cyclists to crusty old guys who have owned half a dozen or more prestigious frames from the best-known makers around the world, and we get unsolicited compliments from close to 40 percent of the buyers. Somewhere in this catalogue are a few of them.

"I've got a few hundred miles on it so far, and it's everything I hoped it would be. It's been completely comfortable from the start, the frame feels great, it looks wonderful... in short, it's by far the best bike I've ever owned, perhaps the best I could imagine!"

Nick M., New Mexico, 59cm Road

ALL-ROUNDER

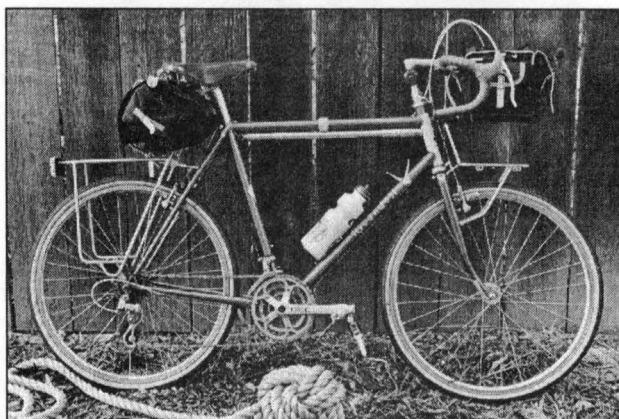

A 55cm All-Rounder set up as a day-touring road bike (it just as easily could have Moustache Handlebars). For touring, just add panniers. For trails or expedition touring, put on some fatter tires. It fits whoppers.

This is our most versatile frame—a jack of all trades, master of most, and for touring, commuting, and most trail and fire-road riding, it is perfect. Its most recent inspiration was the Bridgestone XO-1, made in 1992 and 1993. But the XO-1 itself was modeled after the French 650B-wheeled touring and the British “rough stuff” bikes. These practical breeds go back at least 50 years, and have been unaffected by the same marketing forces that, in the mainstream market, have made extremism the norm.

We’ve designed our All-Rounder to behave like a road bike on the road and with road-like tires, and be a wonderful trail bike for anything from athletic single-track riding to heavily loaded touring. We achieve these goals, which might seem mutually exclusive, by keeping the head tube more like a road bike’s (steeper than a typical mountain bike’s, in other words), and stretching out the distance between the tires enough to make a difference. That’s a good start. Then, when you put thinnish road wheels on it, you have a nice low bottom bracket and the right amount of “trail” (an aspect of the steering geometry that affects how the bike reacts to speed and bumps) for road riding. When you ride it with fat knobbies, the trail increases, and you’re all set for the rough stuff.

In sizes 51 through 59, the combination of road geometry and 26-inch mountain bike-sized wheels gives you all the strength and weight advantages of the smaller wheel, and a wider selection of tires. No drawbacks.

The three larger sizes, 61, 63, and 65cm, are designed for 700c wheels. With our slightly modified new geometry (with 1/2-degree steeper top tube than last year), the head tube increases in length, and if they were still built around 26-inch wheels, the head tubes would be too long (they’d look funny). Fortunately, there are dozens of high-volume 700c tires to choose from, and these large frames still easily accommodate tires up to 700x45, with fenders.

Although we don’t call the All-Rounder a mountain bike, a rider with good skills and only fair judgment can ride it all over mountainous terrain. (The World 24-hour Off Road Record is held on the Bridgestone XO-1.) If you don’t currently own a mountain bike, you may find no need or desire to own one after riding an All-Rounder. And if you do have one, you may still prefer to ride your A/R anywhere you go off-road.

The All-Rounder frame seems made for whatever parts you put on it. With swept-back Priest-style bars and fenders and racks, it’s a perfect short distance commuter. With Moustache H-bars and midsize knobbies, it’s uncatchable on fire roads. With drops and roady tires, it’s as fast on roads as a road bike. Although we don’t call it a touring frame, for loaded touring, it is unbeatable—the best—and riders have toured with it around the world and from Alaska to the Tierra del Fuego. No matter how many bikes you own, this is the one you’ll ride most often. It’s fun to ride and seems right for everything.

LONGLOW



Allen's 60cm LongLow.

The midpriced “sport-touring” frames of the early eighties were arguably the most versatile, all-around practical road bikes ever built, but that didn’t keep them from resoundly replaced by the mid-eighties mountain bike. Our LongLow is basically a fancy, Rivendell version of those long-gone sport tourers. In other words, it’s designed with the same versatility and practicality in mind, but it’s much better made, prettier, rides better, and costs a whole lot more.

The key differences between the Road Standard and LongLow are the tire clearance (and maximum capacity), fenderability, and brake requirements. The LongLow can gobble up a slightly fatter tire (up to 700x38), and there’s room enough for fenders with a tire up to 700x35. The Road Standard maxes out at 700x35 without fenders, and 700x32 with. So, if fenders and rougher roads are a big part of your riding, you might as well get the LongLow.

To create that clearance, the fork has to be a little longer (8mm or so), and the rear brake bridge (the tube that spans the seat stays) has to be that much higher above the dropouts, too. What that means is the LongLow won’t work

with today’s “short reach” sidepulls, so we spec it for cantilevers.

Many of our customers have a hard time deciding between a Road Standard and a LongLow. The Road Standard has a reassuring name; the LongLow sounds extreme in one way or another. It’s not extreme. Originally, “LongLow” was a working name for this bike, because way back in 1997, it had both longer chainstays and a lower bottom bracket than did the Road Standard. We’ve since lowered the bottom bracket on the Road Standard, so they’re the same in that way. The LongLow’s chainstays remain longer, but just a little, and the name sticks.

All the things we say about the Road Standard apply to the LongLow, too. The key geometry differences between the LongLow and our Road Standard are subtle: Half a degree in seat tube and head tube angle here and there; sometimes a little more fork rake; and an extra half to one millimeter of chainstay. It’s hard to talk about the differences in ride quality that result, but our intention was to soften the steering just slightly, and to be honest, it’s hard to tell the difference. That’s a good thing, since the Road Standards already behave so well.

“My enthusiasm for the bike only grows as I ride it. I just can’t imagine it being better.”

Dennis C., Michigan, 60cm LongLow

RIVENDELL BICYCLE WORKS

ALL-ROUNDER

| | 51 | 53 | 55 | 57 | 59 | 61 | 63 | 65 |
|------|------|------|------|------|------|------|------|------|
| ST | 72.5 | 72.5 | 72 | 72 | 72 | 72 | 72 | 72 |
| HT | 72 | 72 | 72 | 72.5 | 72.5 | 72.5 | 72.5 | 72.5 |
| RAKE | 42.5 | 4.25 | 4 | 4 | 4 | 4.25 | 4.25 | 4.25 |
| TT | 52.5 | 53.5 | 56 | 57.5 | 58.5 | 59.5 | 60.5 | 62 |
| CS | 43.5 | 43.5 | 43.5 | 44 | 44 | 45.5 | 45.5 | 45.5 |

Wheel size: 26-inch through 59; 700c for larger. **Seat post:** 27.2. **BB threading:** English (68mm shell). **Headset:** English, 30.2 x 26.4 fork crown race. **Rear spacing:** 135mm. **Brakes:** Cantilever. **Braze-ons:** Three water bottles; brake and derailleur cable stops; pump peg. **Dropouts:** Horizontal, forged steel, 2 eyelets. **Water bottle bolts and seat binder bolt:** Included.

ROAD STANDARD

| | 52 | 53 | 54 | 55 | 56 | 57 | 58 | 59 | 60 | 61 | 62 | 63 | 64 | 65 | 66 |
|------|------|------|------|------|------|-------|------|------|------|------|------|------|------|------|-----|
| ST | 73 | 73 | 73 | 72.5 | 72.5 | 72.5 | 72 | 72 | 72 | 72 | 72 | 72 | 72 | 72 | 72 |
| HT | 72 | 72 | 72.5 | 73 | 73.5 | 73.5 | 73.5 | 73.5 | 73.5 | 73.5 | 73.5 | 73.5 | 73 | 73 | 73 |
| RAKE | 5 | 5 | 4.75 | 4.5 | 4.25 | 4.25 | 4.25 | 4.25 | 4.25 | 4.25 | 4.25 | 4.25 | 4.25 | 4.25 | 4.5 |
| TT | 54 | 54.5 | 55 | 55.5 | 56.5 | 57.25 | 58 | 58.5 | 59 | 59.5 | 60 | 60.5 | 62 | 63 | 63 |
| CS | 42.5 | 42.5 | 42.5 | 42.5 | 43 | 43 | 43 | 43 | 43.5 | 43.5 | 43.5 | 44 | 44.5 | 44.5 | 45 |

Wheel size: 700c. **Seat post:** 27.2. **BB threading:** English (68mm shell). **Headset:** English, 30.2 x 26.4 fork crown race. **Rear spacing:** 130mm. **Brakes:** Allen style, 48mm reach. **Braze-ons:** Two water bottles; brake and derailleur cable stops (external); pump peg. **Dropouts:** Horizontal, forged steel, 1 eyelet. Extra eyelets, \$25 per pair. **Water bottle bolts and seat binder bolt:** Included.

LONGLOW

| | 52 | 53 | 54 | 55 | 56 | 57 | 58 | 59 | 60 | 61 | 62 | 63 | 64 | 65 | 66 |
|------|----|------|------|------|------|-----|------|------|------|------|-----|------|------|-----|-----|
| ST | 73 | 73 | 72.5 | 72.5 | 72.5 | 72 | 72 | 72 | 72 | 72 | 72 | 72 | 72 | 72 | 72 |
| HT | 72 | 72 | 72 | 72.5 | 72.5 | 73 | 73 | 73 | 73 | 73 | 73 | 73 | 73 | 73 | 73 |
| RAKE | 5 | 5 | 4.75 | 4.75 | 4.75 | 4.5 | 4.5 | 4.5 | 4.5 | 4.5 | 4.5 | 4.5 | 4.5 | 4.5 | 4.5 |
| TT | 54 | 54.5 | 55 | 55.5 | 56.5 | 57 | 58 | 58.5 | 59 | 59.5 | 60 | 60.5 | 61.5 | 62 | 63 |
| CS | 43 | 43.5 | 43.5 | 44 | 44 | 44 | 44.5 | 44.5 | 44.5 | 44.5 | 45 | 45 | 45 | 45 | 45 |

Wheel size: 700c. **Seat post:** 27.2. **BB threading:** English (68mm shell). **Headset:** English, 30.2 x 26.4 fork crown race. **Rear spacing:** 130mm. **Brakes:** Allen style, 48mm reach. **Braze-ons:** Two water bottles; brake and derailleur cable stops (external); pump peg. **Dropouts:** Horizontal, forged steel, 2 eyelets. **Water bottle bolts and seat binder bolt:** Included.

All geometries and specifications subject to change without notice, but if it happens after you order your frame and in our opinion it's anything particularly major, we'll let you know.

Custom frames

If none of our models and sizes works for you, we can design a custom that will. "Custom" means we design it around your body's peculiarities. All customs still conform to our standard design and detail values. Upcharge: \$300.

Position is Everything

It's easy and fun to get absorbed in frame sizing and geometry charts and tube specs and trail figures and bicycle numerology in general, but the goal of everything, and the most important and influential aspect of your bicycle isn't how it's laid out, but how it lays you out.

Personal preference always plays a role, but you can get used to and even come to prefer a bad position that actually does you harm over the years; that's how adaptable your body is. The good news is that it takes almost no time at all to feel right at home on a properly set-up bike, regardless of how many years you've been scrunched, hunched, and overly stretched.

When you're in your riding position with your hands on the hoods, you should be able to remove your hands—put them behind your back, even—without plopping-down onto the stem. We're less adamant about the knee position relative to the pedal, but mention our preference here only to get you thinking. We like it behind the center of the pedal, because that way, the downstroke helps you maintain a rearward position on the saddle. If it's directly above it, you tend to scooch forward more. In any case, it is not easy to achieve this position with a normal, off-the-shelf bicycle and conventional sizing methods. You'd think it would be, or it ought to be, but it isn't.

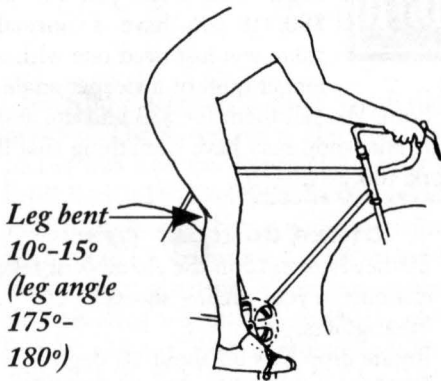

Your leg is bent just a little at the bottom of the stroke and you can pedal a full circle without tilting your hips. If you drop your heel, the saddle is probably too low, and your leg is trying to extend. If you pedal toes-down, it's probably too high, in which you'll rock side to side, increase pressure on your crotch, and damage your tendons, which, at the bottom of the stroke, will try to simultaneously stretch and contract. If your knee is bent too much at the bottom of the stroke, you'll damage the cartilage under your knee cap, and feel a dull pain in your knee, two days following a hard ride. And your thighs will tire faster.

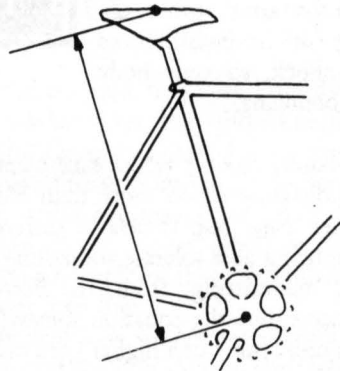

LEARN YOUR SADDLE HEIGHT!

If you ever go nuts and order a frame here, this is one of the first measurements we'll ask for. If you have several bikes already and they all seem to feel good in the leg-extension department, measure them all and see if they're all the same. The shoes and pedals affect it.

There's a relationship between saddle height and barefoot pubic bone height. If you're 5' 5" inches or shorter, it's almost always around 9cm; never less than 8 or more than 10. If you're between 5' 6" and 6' 1", it'll be smack dab on 10. Maybe 10.3, but certainly not 11. On taller riders, it's between 10.5 and as much as 12cm.

How To Be Comfortable Even Though The Odds Are Against It

The current trend of getting a small frames and jacking up the seat posts is a recent blip that spread from mountain bikes to road bikes, and is reinforced in the media and in bicycle shops and in public as proper and normal. That doesn't make it good. It's not good. It's bad!

The problem with getting a bike that requires a giraffe seat post, is that you then need a giraffe stem. If you have a giraffe seat post and no giraffe stem, the bars will be too low. As a result, you lean over too far, so your back hurts and you strain your neck to see. You carry too much weight on your hands, so they get sore, maybe even damaged. Your arms stiffen up, making it impossible to absorb shock, so your body takes a bouncing.

Young skinny flexible riders can tolerate a low-handlebar position more than old fat stiff ones can, but there's a difference between being able to tolerate something and actually benefitting from it. Personal preference enters the equation somewhere, too, but don't rule out a higher bar position until you've tried it. Man, it's hard not to like.

**RAISE
YOUR
HANDLEBAR**

Let's say you have a two year old bike that was exciting at first, but now that as the novelty is gone, you're faced with the reality that you graduated to a more expensive, better bike that isn't as comfortable. It happens all the time.

If you want to keep the bike, just get a stem that allows you to raise the handlebars. Try to get the top of the handlebars to within an inch of the top of the saddle.

If you have an Aheadset stem, it's harder but still do-able. You just have to buy a new stem with a different rise angle. That'll run you \$40 to \$80. If you have a normal stem, you just need one with a longer quill or a steeper angle,

or both. We sell them for \$33 and up, and your bike shop may have something that'll work, too.

OTHER COMFORT TIPS:

- Slather Nozzema on the chamois or fake chamois in your cycling shorts.
- Wear gloves.
- Rotate drop bars up about 10-degrees.
- Change your hand position frequently.
- Take a break.

"The frame is everything you said it would be. The detail and craftsmanship are truly special. The bike's striking appearance draws compliments from all knowledgeable riders who see it. It's amusing to see people figure out what they are looking at. I wasn't sure I would be able to discern such subtle {handling differences}. I was wrong! The additional stiffness is very apparent, with no compromise in its ability to absorb bumps. Climbing is improved!! It retains that unique steel feeling of smoothness and the improved stability in high speed turns is very noticeable. But best of all is the fit — no more stiff necks and shoulders after 3 hours on the bike.

This is a bike that will encourage me to ride more."

Art M., Atlanta, 64cm Road:

A Good Position For Many Riders

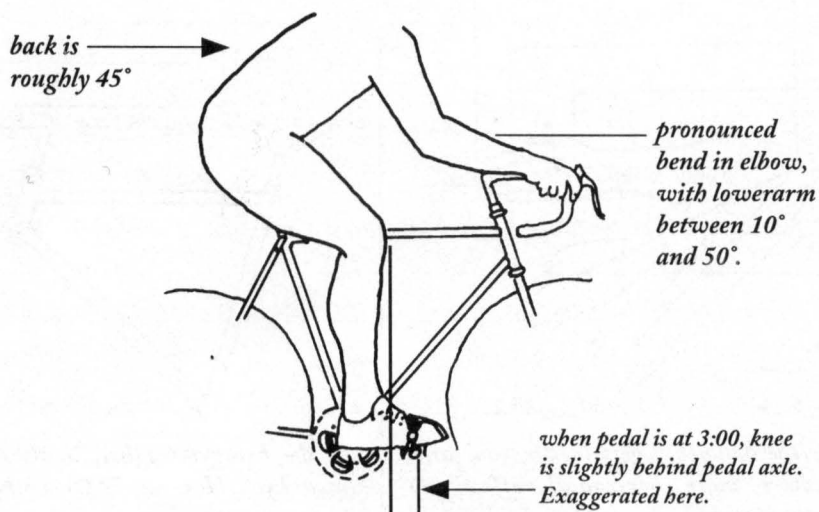

Stem Fitting Notes

This fellow here has a good, comfortable position. The 45-degree angle in his back means he's not too hunched over, so his lower back is less likely to ache the next day. Plus, it lets him see better, without straining his neck to lift up his head (thus saving his neck). The slight bend in his elbow suggests that his arms are relaxed, ready to soak up bumps without even a moment's notice. Although we'll never know for sure, it's a good bet that he could remove his hands from the bars, put them behind his back, and pretty much maintain the same upper body position, as opposed to flopping down forward. That's how it ought to be.

You can't see his saddle, but if you were to measure from the ground to the top of it, and then from the ground to the top of the

handlebar, you'd find very little difference. On smaller bikes, they should be the same height. On giant bikes for long-armed riders, the difference can be up to 4cm. If you look at this relationship on bikes shown in magazines, on racers' bikes, and even on your own, you'll see that it is probably more greater than that.

With drop bars, it's not necessary. Try to set the top of the bars close to the same height as your saddle (hard to do this on most bikes). The whole idea of drops in the first place was to give you this level-top position; then, when you want to get down lower, you go down onto the drops. It may sound like a broken record, but it's an important point worth repeating: If you get a sore back, neck, hands, or arms, raise them bars!

"Without reservation it's the best riding, most comfortable and best looking bike I've ever owned. The fit is perfect."

Ed B., Maine, 53 Road

The Unimportance of Top Tube Length

OR AT LEAST, ARGUMENTS IN FAVOR OF NOT FIXATING ON IT

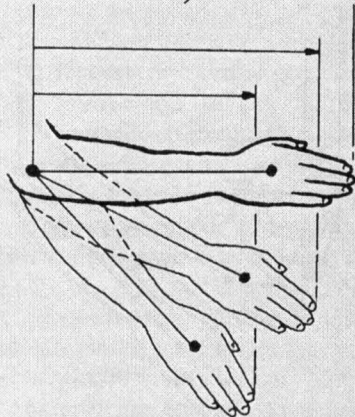

As the handlebar gets higher, your arm becomes more horizontal, effectively getting longer.

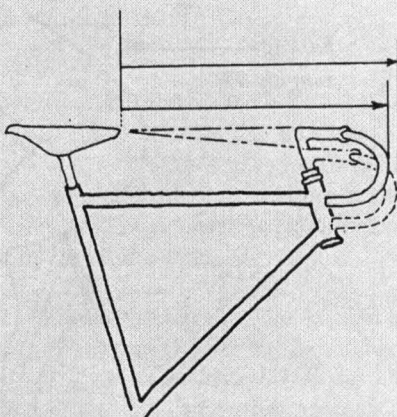

As the bar gets higher, it also retreats toward you. How much? On a bike with a 73.5-degree head tube, raising it 4cm brings it back 1.5cm. If the head tube is shallower, it'll come back more.

By studying the two pictures up there, you'll see why getting a shorter stem without also raising the bars can have a self-cancelling effect. And how, if you raise the bars, you may even need a longer stem. By sort of the same token, top tubes of a given length tend to feel shorter on bigger frames than on smaller ones. So if you currently ride a 56cm bike with a 55cm top tube, but you know you can fit a 58cm frame, don't be scared off it just because it has a 57cm top tube.

SADDLE HEIGHT AND PUBIC BONE HEIGHT

TIP FOR MEASURING PUBIC BONE HEIGHT

With your bare feet ten to twelve inches apart; measure from the floor up to your pubic bone. Hook a metal tape through a thin, hardcover book or a record album cover, and push up until you smash into the bone. Have a friend take the reading on the floor.

TIP FOR SETTING YOUR SADDLE HEIGHT

Start with your saddle clearly too high, and move in down in small increments—5mm or so—until it feels good. (It's best to start with it too high, rather than too low, because too high always feels funny, and too low isn't as obvious). When the height feels right, mark the seat post at that point (a finepoint sharpie works), then continue moving it down, still 5mm at a time, until it's clearly too low. Have a friend watch you pedal. At the bottom of the stroke, your foot should be horizontal, and your hips shouldn't tilt as you pedal.

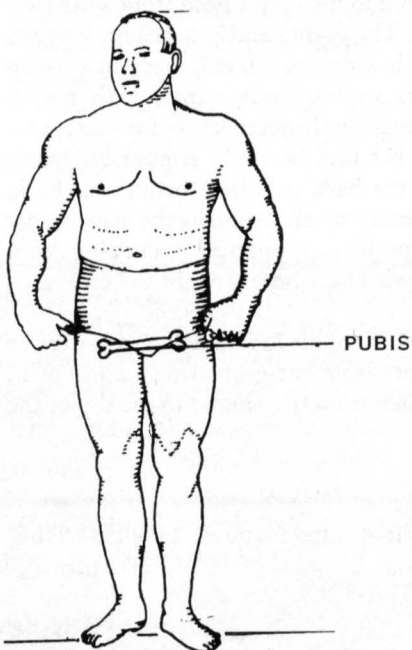

RIVENDELL FRAME ORDER FORM

Date submitted: ___/___/___

Name _____

Address _____ City _____ State _____ Zip _____

Day Phone () _____ Fax () _____ email _____

Age _____ Height _____ Weight _____

Pubic BONE height (see page 18) in bare feet _____ In cycling shoes _____

Saddle height on current bike (see page 15) : _____ cm (inches x 2.54).

Years riding as an adult _____ Current favorite bike (model, size, comments) _____

Type of riding you will do on this bike: _____ Approx. yearly miles: _____

Typical tire: _____ Largest tire: _____ % of time riding on largest tire: _____

What style handlebars will you ride? Drops ___ Moustache ___ Both? ___ Other? ___

Model(circle one): **Road Std** **LongLow** **All-Rounder**

Size (c-t): Rivendell's choice _____ No. Please build a _____

COLORS

3 Metallic Blues: Light, medium, dark.

3 Greens: Grey-green; Coleman Stove; Dark Green (metallic).

1 Orange: Burnt.

All frames have cream head tube panels and lug cutouts. When we get a deposit, we'll send out photos or color chips with your first receipt; then you have a month to decide. Or you can see them on our website: Rivendellbicycles.com.

DELIVERY

2 to 3 months. Call anytime for updates.

PRICE AND PAYMENT

Note: Includes prepping, anti-rusting inside the tubes, two water bottles, water bottle bolts, seat binder, and a cap. Full payment is due before your frame gets paint.)

ROAD\$1500

LONGLOW\$1525

ALL-ROUNDER\$1575

Other comments?
Photocopy this and write
on the back, or submit a
separate page.

Other: **BOTTOM BRACKET:** Phil Wood (to fit your cranks): \$135 installed. Want it? _____ (other bbs available; ask)

HEADSET: Tange Rollerball (we love it): \$50 installed. Want it? _____

Deposit: \$300. Check or credit card. Balance before shipping. If you cancel after 60 days, we refund as Rivendell credit.

Freight: UPS Ground is \$35 per frame, \$50 per complete bike. International, \$200. For faster methods, call.

Payment Enclosed: Visa or MasterCard #: _____ expires ___/___/___ Your Signature: _____

Rivendell Bicycle Works / Frame Dept.
1561-B Third Avenue, Walnut Creek, CA 94596
ph (925) 933-7304 or fax (925) 933-7305

Zipperless Bike Bags

Bags make bikes more useful. How else are you going to carry a small camera so you can take some pictures of your rides, so when you're 85 your can look back with great memories? Or carry a rain cape in case it rains, or a big old thick sweater in case it gets freezing out there? Bags is how!

We offer a variety, from a simple 16-inch square of waxed cotton—which is a bag only when you roll it up like a burrito—to rear panniers capacious enough for two Thanksgiving dinners for four. All our baggage is simple in design, sturdy and well-made, and conspicuously lacking in clever yet fragile convenience features (like zippers and quick-release buckles).

Most soft luggage and packs are made from 6 to 7oz nylon pack cloth or a heavier, 11.5oz Cordura nylon. Nylon is cheap to buy, easy to sew, and has been sold on its tear strength and abrasion resistance, which isn't so honest. High tear strength and abrasion resistance are desirable, but most nylon packs fail at the seams. I used to coat the edges with Pliobond, and it still happened. Another problem with nylon is that prolonged exposure to sunlight kills it. Rock climbers see 4,000-lb test nylon webbing, after prolonged exposure, weakened to the point where they can break it with their hands. At high altitude, continuous sun can turn a lightweight nylon tent into rice paper in sixty days, sometimes less.

Lowly old cotton duck can bake in the sun with little damage, and if it starts to fray, it gets fuzzy fast, and the fuzzy edges prevent additional fraying in much the same way that tangled or dreadlocked hair is hard to comb. That's why you can cut off your blue jeans and wear them unhemmed. You can't do that to nylon.

Cotton lacks nylon's abrasion resistance and tear strength, but a tight weave of heavy cotton duck is plenty strong in both regards, and a pack made of it will outlast a nylon one three times over. Hemp is even stronger than cotton, but it's expensive to buy, and we've yet to see hemp with the fine, dense weave of a high-quality cotton duck.

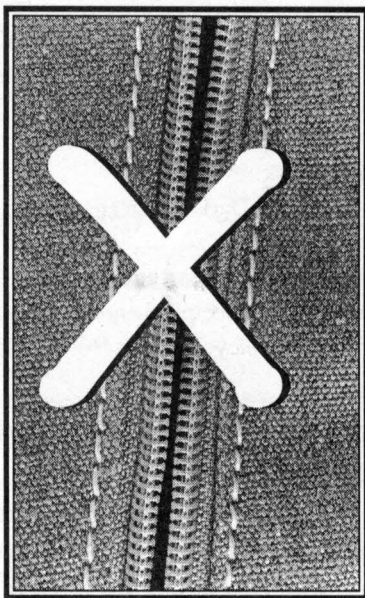

Another weak point in packs is zippers, especially plastic or nylon ones, and especially coil zippers, and the smaller the coil and the more you use it and the more it's stressed, the sooner it'll go. The coil abrades the inside of the slider, the slider itself gets bent, and the next thing

you know, your self-repairing coil zipper is self-opening, too. For light use, the amount most panniers are subject too, they're okay.

For hard continuous use, and whenever security is more important than one-click convenience or instant access, we like 14oz cotton duck on the Carradice bags, and the the metal prong buckles.

New in our line this year is the Duluth Banana Bag. It's kind of pricey, but really nicely made, and it may be just the size you're looking for.

—Grant

Carradice Cycle Bags, From England

Carradice bags are made in England with designs, fabrics, and methods that have proven reliable since 1932. The fabric is 14-oz waxed cotton duck. Up until last year, it was waxed in Britain by British Millerain. Then BM got some new, fancy machines which couldn't handle the heavy fabric and waxing, so Carradice now gets the fabric waxing in Scotland (of kilt fame). It's just as good, and passes all the same tests with the same flying color, but it smells different. The straps are still thick leather, and the buckles are still zinc-plated steel. These are exceptional bags built to be used every day, and used every day, they'll last 20 years. A few of our customers have 25-year-old Carradices that are still in good service. Old Carradices fade to grey.

Between 1929 and 1952, virtually every saddle in England wore a saddlebag, and Carradice was the brand of choice. They are the traditional "transverse" style, which means they stick out, catch the wind, sway a bit, and gently massage your legs on the backstroke. They require some method of attachment on the saddle, such as the loops built into some Brooks models, or an adapter. The Nitto Uplift on page 29 is ideal.

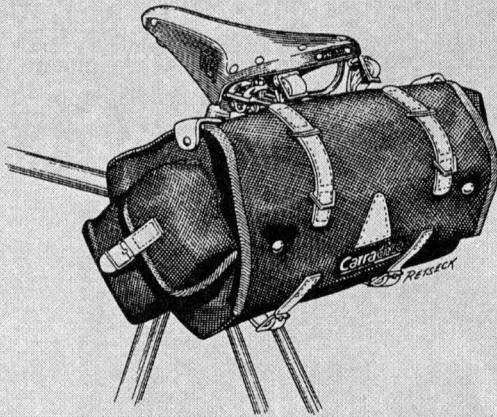

Saddlebags are the best way to carry medium loads, and with enough lashing straps and creativity, you can carry bulky, unwieldy, oddly shaped cargo that won't even begin to fit in the main pouch.

⚠ SMALL WARNING

Shown alongside modern packs made of laboratory-born fabrics and computer-designed buckles and features, a Carradice looks like a homemade pack for hauling coal. The fabric is starchy and black and stiff, and the thick, stiff

leather is too pale. There's nothing distressed or acid-washed or pre-softened about Carradice bags, and they take a month of hard use before the prong fits in the hole right, and years before

they start approaching photogenic.

For keeping your gear dry and secure, and standing up to the hardest use for the next couple of decades, Carradice is the best we've seen or used. There aren't many bicycle-type accessories you can actually grow old with, but this is one of them.

—Grant

CARRADICE NELSON LONGFLAP

The basic, standard, normal, generic Carradice saddlebag. It's about 15 percent bigger than the LSLF, and if your bike can fit it, you might as well get it. It requires at least twelve inches between your saddle loops and a bare tire, otherwise it may rub.

Big enough for a large thermos bottle, mittens, rain cape, heavy wool shirt or sweater, lunch for four, and the normal emergency roadside repair stuff. D-rings on the top flap allow you to tie on extra stuff, and it's always a Good Idea to bring along some thin rope to do it with. Now with an expensive leather abrasion patch that caused the price to go up a couple dollars.

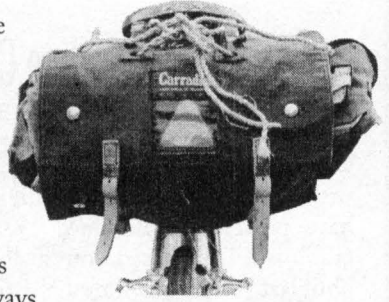

| |
|---------------------|
| ITEM# 20-010 |
| MEMBER PRICE \$70 |
| NON-MEMBER \$72 |

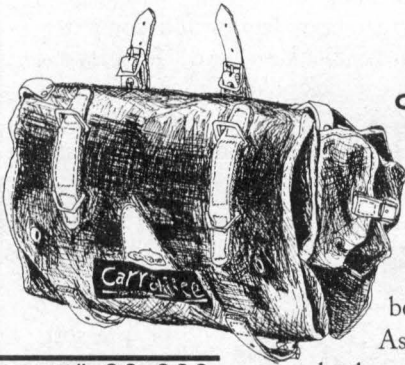

CARRADICE LOWSADDLE LONGFLAP

A hobbit-sized version of the Nelson Longflap, originally designed for small bikes, which, if they're sized anywhere near correctly, will put the saddle too close to the rear wheel to fit the Nelson. As a rule, it requires a minimum of ten and a half inches between the saddle loops and the top of the tire. Assuming you don't have fenders or a rack. With pricey leather abrasion patch on the bottom.

| |
|---------------------|
| ITEM# 20-009 |
| MEMBER PRICE \$70 |
| NON-MEMBER \$72 |

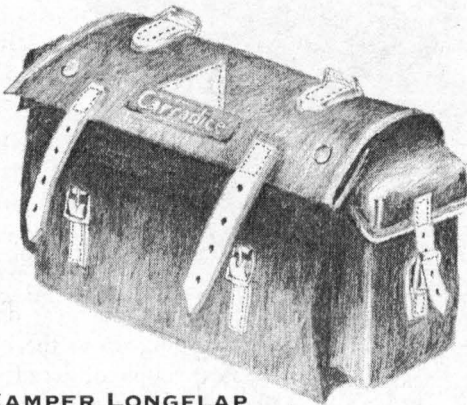

| |
|---------------------|
| ITEM# 20-006 |
| MEMBER PRICE \$75 |
| NON-MEMBER \$79 |

CARRADICE CAMPER LONGFLAP

This bag is designed for travelers who need to carry a lot, but for philosophical or financial or bike frame limitations or mechanical ineptitude reasons refuse to carry racks and panniers. It's styled exactly like longflaps Lowsaddle and Nelson, but is just bigger everywhere. The side pockets are deep enough to swallow standard sized water bottles whole. As an experiment, we once fit thirteen Brooks B.17 saddles into one—that's how big it is. As with all the Carradice saddlebags, it's easy enough to rig up a shoulder strap from the d-rings or something. With the same leather abrasion patch as its brother and sister.

∞ BAGS SANS ZIPPERS ∞

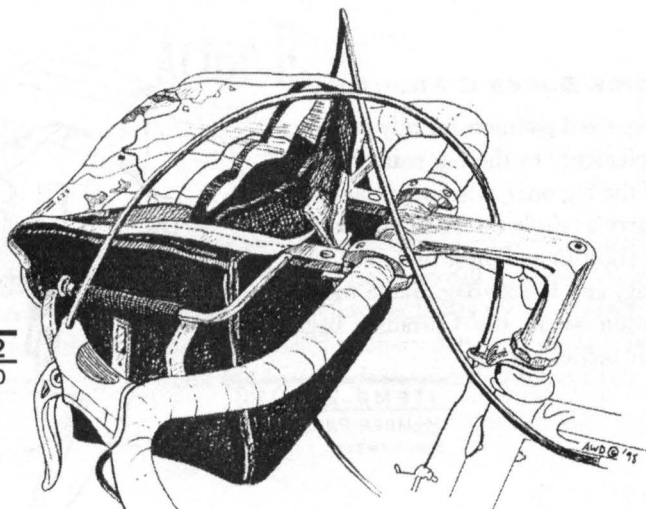

ITEM# 20-032

MEMBER PRICE \$60

NON-MEMBER \$65

CARRADICE BOXY BAG

This style handlebar bag, originally a French design, has been around for at least 50 years. Ours is made to our spec by Carradice, and is a more rugged than many of those French ones. Lots of people say "Hey, handlebar bags are bad. They mess up your steering!," to which we reply "Not if you don't carry shot puts." This is a delightful bag to use, so convenient, ideal for small loads you want to get at. Four outside pockets for small things. A removable map case holds a map, your children's artwork, or a picture of your fantasy road for you to look at while you're pedaling. Requires the Nitto BoxyBag support, sold separately.

Why Top Loading Good!

Don't get the idea that when you get a top-loading bag, you're sacrificing daily convenience for long-term peace of mind. Top-loading bags just require a different packing method, and in some cases, are much more convenient.

The best way to organize your top-loader is with stuff sacks. Color coded or mesh ones are best. Use one each for your cooking gear, first aid kit, dinner, spare clothing, dirty clothes, tools, and so forth. You just turn your single-compartment bag into a modular, multicompartment one. If you have something big and gangly to carry, you don't have fixed compartments to frustrate you. You can fill up the compartment and still cram those antlers on top, because you don't have



to close a zipper around them. You can pack up while wearing mittens, jam the stuff down there, and cinch up the straps with all your might. It will fit.

I've worn out at least ten zippers in my life, on otherwise "built to last a lifetime" bags. I gave up on No. 7 coils, then I gave up on No. 10 coils, and eventually I even wore out the big metal zipper on my L.L. Bean duffel bag. When I worked at REI years ago, we saw zippers come back ruined all the time. I've seen probably 200 broken coil zippers in my life, but never a broken metal buckle. Zippered compartments and plastic buckles aren't heinous; they just aren't as reliable as top-loading and metal buckles.

—Grant

CARRADICE SUPER C FRONT

Medium-sized panniers for tidy packers, or as supplements to the big rear ones, or instead of the big ones, whenever you don't need to carry a whole lot. A smart combination for short tours: These on low-riders, a saddlebag, and a BoxyBag. Same tough, waxed cotton as all the Carradice bags. 1,464 cubic inches per pair.



| | |
|---------------------|------|
| ITEM# 20-013 | |
| MEMBER PRICE | \$60 |
| NON-MEMBER | \$65 |

CARRADICE SUPER C REAR

Huge to a fault, if that were possible, and in rear panniers, it ain't. It's not like you have to put 35 pound in each one of them; sometimes you just need more space to carry a box of puffy cereal, or a heavy wool jacket that don't pack so well. A built-in coated nylon extension sleeve lets you overfill the main compartment and still protect your gear from the weather. What good would that be if the straps weren't cut extra long? None, is what! One outside pocket holds a fuel bottle or water bottle. While your heinous, low-life, convenience-seeking cycling partners are cursing their zippers on cold mornings, you're already packed. Slobbishly, but it's all in there and that's what counts.

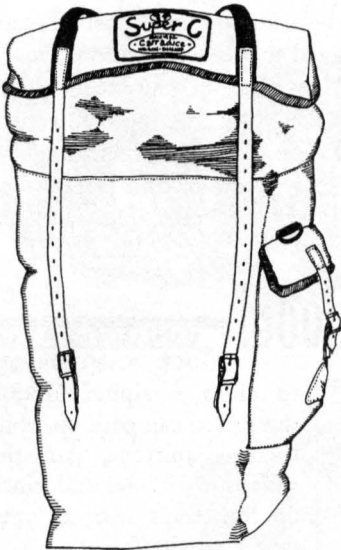

| | |
|---------------------|-------|
| ITEM# 20-014 | |
| MEMBER PRICE | \$132 |
| NON-MEMBER | \$140 |

COBBWORKS-CARRADICE TENSION STRAP

Those of you who bought your Carradice bags from us know we've been making our own strap system for them. What you don't know is that it's always been a pain. We run out of webbing, we run out of clips, the local hardware store has to special order them again, we wait weeks, and when they finally come in, action stops until we cut up the webbing and make the straps. Then we fill the backorders. Thank Buddha Mike Cobb looked at ours and said "I can do that, only better," and wasn't fibbing. If you've got your Rivendell-made straps, fine—they're good, keep using them. But from now on all Carradice Super C front and rear bags come with the Cobbworks version. That's why our price jumped up \$20 a set. Worth it! Simple, strong, super secure, and the bags go on and off in a jiffy now. Retrofit kits, \$20. They come with the Super C panniers.

| | |
|---------------------|------|
| ITEM# 20-040 | |
| MEMBER PRICE | \$20 |
| NON-MEMBER | \$25 |

Acme Bags



ometimes we want a bag or something else that isn't commercially available, so we have it made, and leave it logo-less, and call it Acme. Webster's New Universal Unabridged Dictionary defines ACME as *the top or highest point; the height or crisis of anything*. Another dictionary defines it as *the point of utmost attainment*. We can think of no better descriptions of these bags.

ACME LEATHER SADDLEPOUCH

Member and Baltimore-based leatherworker Steve Jackson makes these for us out of think pinkish leather that darkens with use, time, and oiling. It's held together with fat-head copper rivets, and the buckles are brass. Leather, copper, brass—what's not to like? Rub the leather dressing of your choice into this, warm it up with a hair dryer so it soaks in good, and you have a tough and totally waterproof bag for the rest of the year. Big enough to hold a wallet, keys, a few tools and a spare tube. Four holes on the outside let you tie on a rain cape or the Sunday paper, and a slit fits many red flasher lights. It's not wide enough for your favorite one, cut it wider. This is a smart, beautiful bag that works great and will outlast most bikes you put it on.

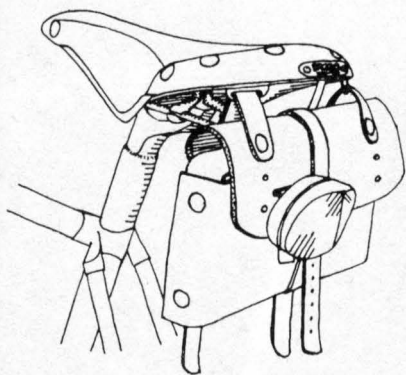

ITEM# 20-028

MEMBER PRICE \$42
NON-MEMBER \$45

ACME TOOL AND TUBE TOTE

It's a 17" x 17" square of unhemmed Filson Tin cloth, the same 12 oz. waxed cotton that Filson has made its toughest pants and jackets out of for a hundred years or more. Lay it flat, and put your daily needs in one corner. Roll it a few times, fold in the side corners, then complete the roll and secure it to the saddle rails with a leather toe strap. If you stop to fix a flat, open it up and lay it down like a placemat. That way you won't lose anything under the leaves.

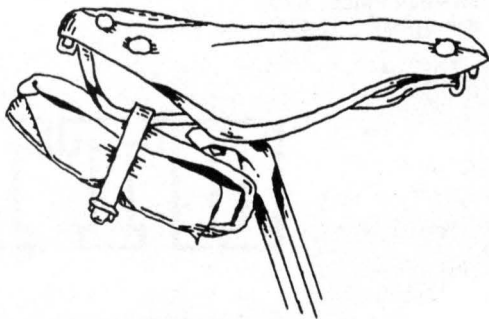

ITEM# 20-003

MEMBER PRICE \$3
NON-MEMBER \$4

DULUTH BANANA BAG

There's a bag maker in France, called Gilles Berthout, who makes a bag like this, and I/Grant had one years ago, but it was on a bike that got stolen, and I tried to contact GB for another, but no luck. So I borrowed member John Bayley's, sent it to Duluth Tent and Awning (canoe pack people) for copying, and a year and tons of correspondence later, here it is. It's not an exact copy—we added an inner sleeve pocket, for change or a dollar bill or something; and comes in olive green instead of greyish blue. Ours is the Banana Bag because it's made in Duluth and is perfect for medium-sized bananas (remember them?). It's good for other stuff too, and if you can't quit cram it all in, you can tie the excess on top, using the leather thongs. This is a beautifully detailed bag, with no corners cut, made of the very best and most expensive materials. Perfect size for long day rides where you don't have to carry Carradice-sized loads.

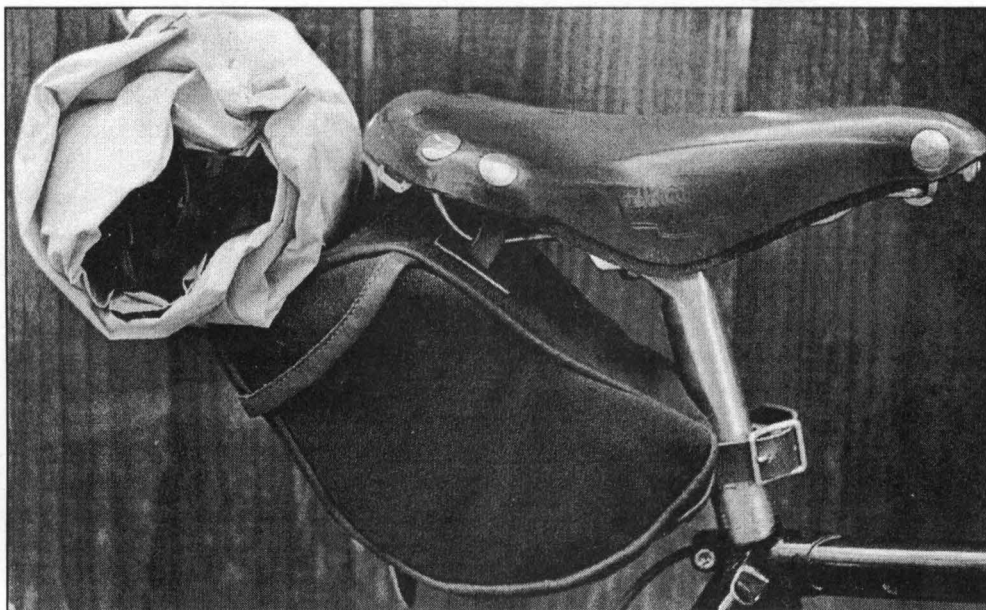

ITEM# 20-041

MEMBER PRICE \$70

NON-MEMBER \$78

Nitto of Tokyo

N

obody makes anything better than Nitto makes anything Nitto makes. Handlebars, stems, seat posts, racks, bottle cages—if it can be forged, bent, fillet brazed or welded, Nitto does it, and they're the best in the world at whatever it is.

Nitto designs are simple and clever, with nothing extra and nothing lacking.

Nitto curves are beautiful, Nitto joints are strong, and Nitto's top finish is mirrorlike. Nitto bike parts jewel-like.

Nitto is a family-owned business in Tokyo, with eighty-five employees. The big bosses are the Yoshikawas, and even among Japanese companies, they seem off on their own. Nitto's chairman loves bicycles, and rides one every day. He has refused to compromise quality or farm out production.

Nitto isn't oblivious to market trends, but doesn't bend over backward to follow fads down to oblivion or embarrassment, whichever comes first. They're selective about what they design themselves, and what they'll make as subcontractors for others.

Unpacking a Nitto box is an event here. The boxes are premium cardboard, much better than the boxes from Italy, Taiwan, England, France, and America. They're so solid you can whack them hard with a cue ball-sized monkey's fist on the end of a two-foot tether, and it barely leaves a mark.

Inside the boxes, stems are lined up like soldiers, handlebars are tied in neat groups of five, the ribbons linking them color-coded according to width. There's not much air in a box full of handlebars, and maybe you have to have packed them to appreciate that. Never are two models packed in the same box. The exact contents of each box is clearly marked on the outside, and whenever we think we've been misshipped, a recount always proves our error.

We've never seen any parts and accessories maker with Nitto's quality, attention to detail, and quality control. When you buy a Nitto anything, you won't have to buy another one later, and your standards will never be the same.

—Grant



NITTO

RACKS AND MOUNTS

NITTO BOTTLE CAGE

This might be the prettiest thing Nitto makes, expensive for a bottle cage, but possibly the least expensive fillet-brazed anything you can buy. The perfect gift for cyclists who can't bring themselves to spend \$30 on a bottle cage. 53g.

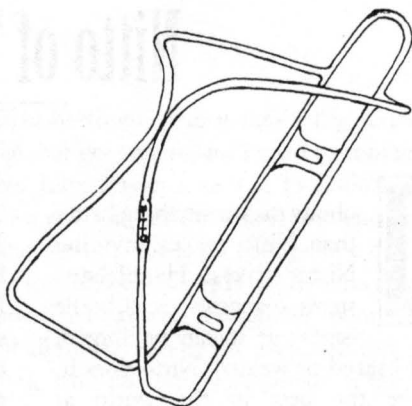

| | |
|---------------------|------|
| ITEM# 20-030 | |
| MEMBER PRICE | \$30 |
| NON-MEMBER | \$35 |

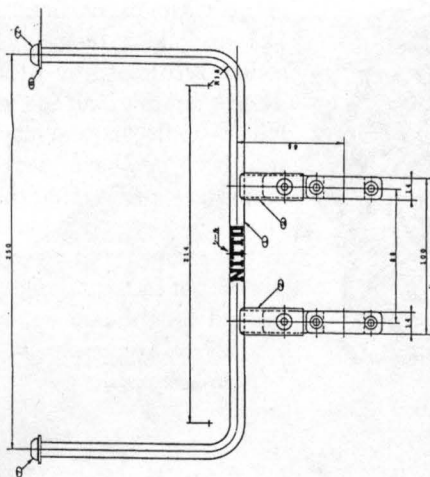

NITTO BOXYBAG RACK

Made especially for the Carradice BoxyBag. It clamps onto drop bar sleeves between 25.4mm and 26.4mm diameter, and tightens with 4mm allen's. We'll try really hard to keep the Boxies and these racks in stock at all times, but they're both non-standard items for their respective manufacturers, and made at opposite ends of the world, so at any given time, we may be out of one or the other.

| | |
|---------------------|------|
| ITEM# 20-031 | |
| MEMBER PRICE | \$46 |
| NON-MEMBER | \$49 |

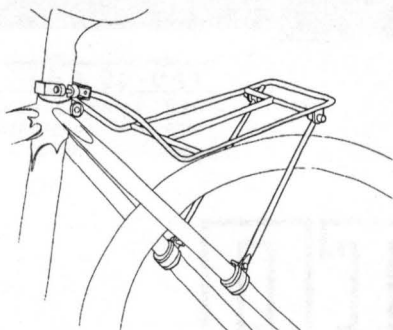

NITTO SADDLEBAG SUPPORT/MINI REAR

Two purposes: One, it allows you to carry a too big and/or poorly loaded saddlebag on a small bike, without it rubbing the tire. Two, it's a mini rack all by itself. You can strap stuff on to it. Really handy, light, and simple to mount, as it attaches to the seat post and seat stays. It fits seat stays around 14mm to 16mm in diameter, and if yours are smaller, just build them up with tape. In time we'll get a Carradice rackbag for this rack. Maybe by Summer.

| | |
|---------------------|------|
| ITEM# 20-029 | |
| MEMBER PRICE | \$60 |
| NON-MEMBER | \$65 |

MORE RACKS

NITTO REAR RACK

The best racks are tubular steel. It's stronger than aluminum, and if it does break, it's easier to get a guy in a turban to weld it up for you. The best designed rear racks have widely spaced supports (as opposed to V-shaped ones), which stabilize your bags and keep them from wobbling. These Nitto racks satisfy both those requirements, and are a soft, satiny silver, too, so they enhance the look of any nice bike. You can keep them on always.

The only problem we've had with these is delivery—they're just plain hard to get, and it seems like we're constantly out. We'll make every effort to keep them in stock, but you can always bail out with a Gordon, a Beckman, one of Esge's best if you can find one, or a Jaanndd, which, even though it's aluminum, seems to be quite good.

Each rack comes with a small assortment of seatstay connecting rods, and you use the ones that best fit your frame. If you don't have brazed-on rack mounts, use the included clamps, which are sized for 16mm seat stays.

Two sizes: Medium, for frames up to 57cm; Large, for bigger.

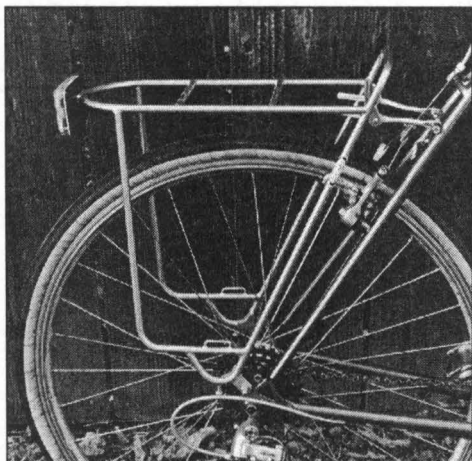

MEDIUM

| |
|---------------------|
| ITEM# 20-022 |
| MEMBER PRICE \$125 |
| NON-MEMBER \$130 |

LARGE

| |
|---------------------|
| ITEM# 20-021 |
| MEMBER PRICE \$125 |
| NON-MEMBER \$130 |

NITTO SADDLEBAG UPLIFT

If you can't just strap a Carradice onto your saddle (maybe your saddle's too low; maybe it lacks loops), then get this. Unlike most other such devices on the market (and over the years there have been a dozen or so), this one mounts to the seat post, not the seat rails.

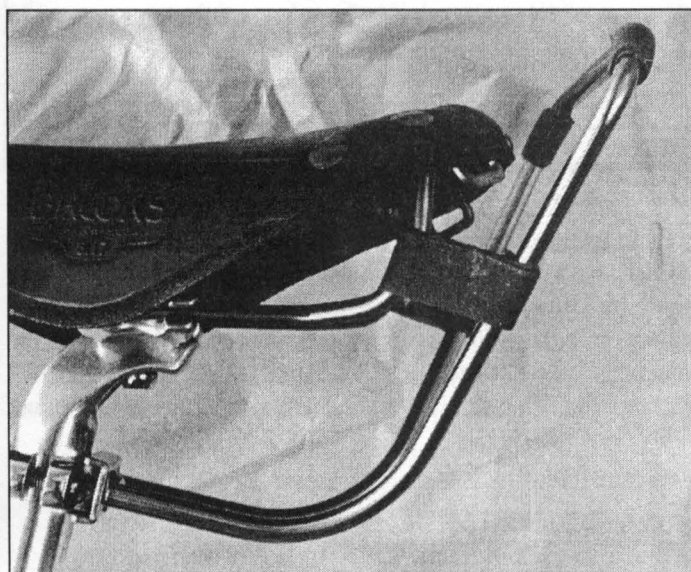

This is better, because seat rail configurations vary, making universal fits impossible. This bugger comes with instructions, which explains the tape you see in the picture there. A wonderful device. It must be good for the other things as well, though we can't think of any offhand.

| |
|---------------------|
| ITEM# 20-036 |
| MEMBER PRICE \$30 |
| NON-MEMBER \$32 |

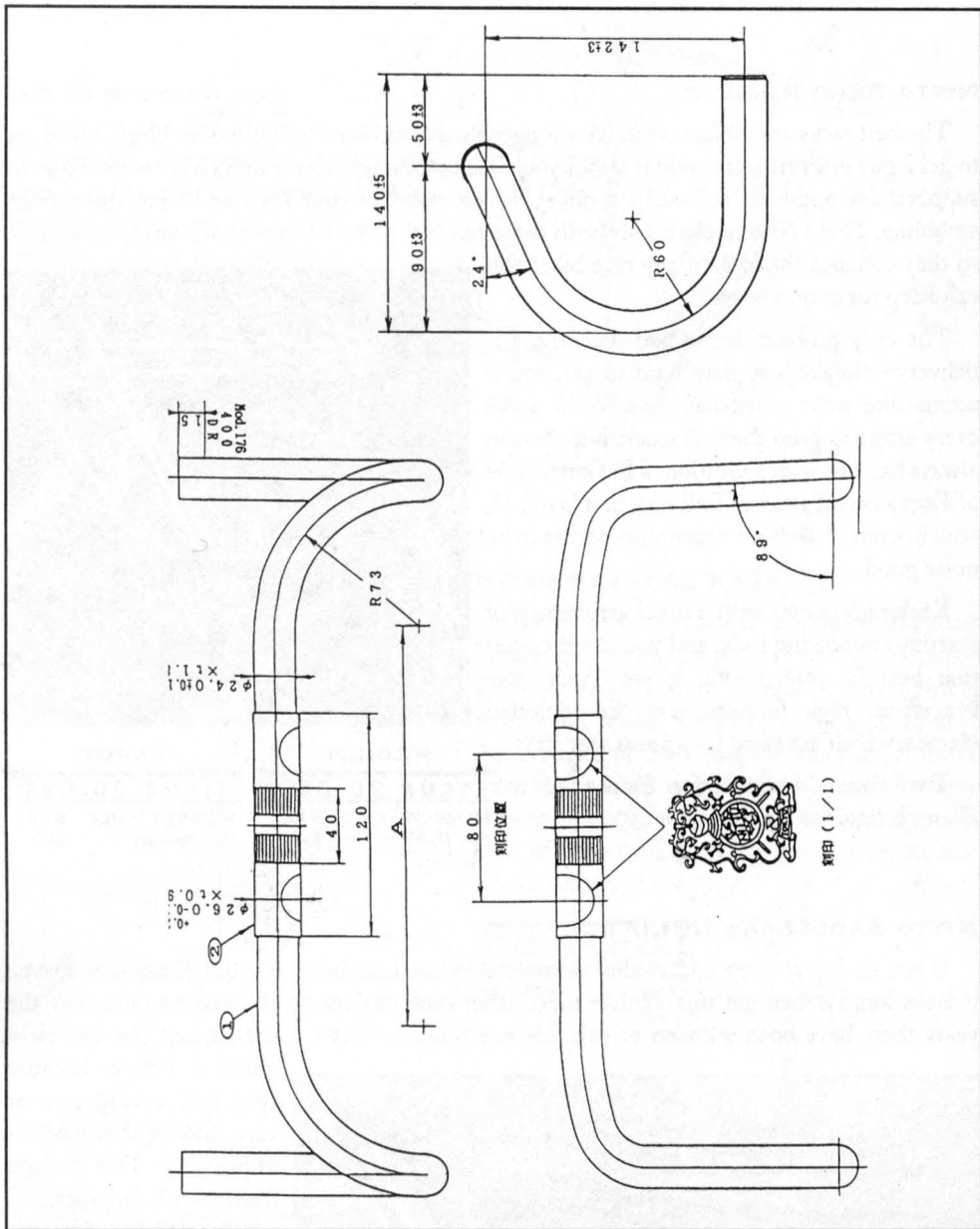

NITTO MODEL 176 (DREAM BAR)

We sent Nitto specs for a “dream handlebar,” and a month later the prototype came, labeled “dream bar.” Then, in keeping with its preferred numbering system, Nitto assigned the dream bar No. 176, so that’s its official name. It combines the large, roomy radius of a deep drop bar—with a medium drop of 142mm—2mm deeper than the 185, and the relatively flat, hand-supporting upper curve of the DirtDrop. An all-round road drop that’s hard not to love. You can, for clarity’s sake, order it as the Dream Bar, without us thinking you’re going along with the silly nomenclature.

Weight(42cm): 330g. • Sizes available: 40-42-44cm

| 40 CM | 42 CM | 44 CM |
|---------------------|---------------------|---------------------|
| ITEM# 16-080 | ITEM# 16-081 | ITEM# 16-082 |
| MEMBER PRICE \$40 | MEMBER PRICE \$40 | MEMBER PRICE \$40 |
| NON-MEMBER \$42 | NON-MEMBER \$42 | NON-MEMBER \$42 |

HANDLEBARS

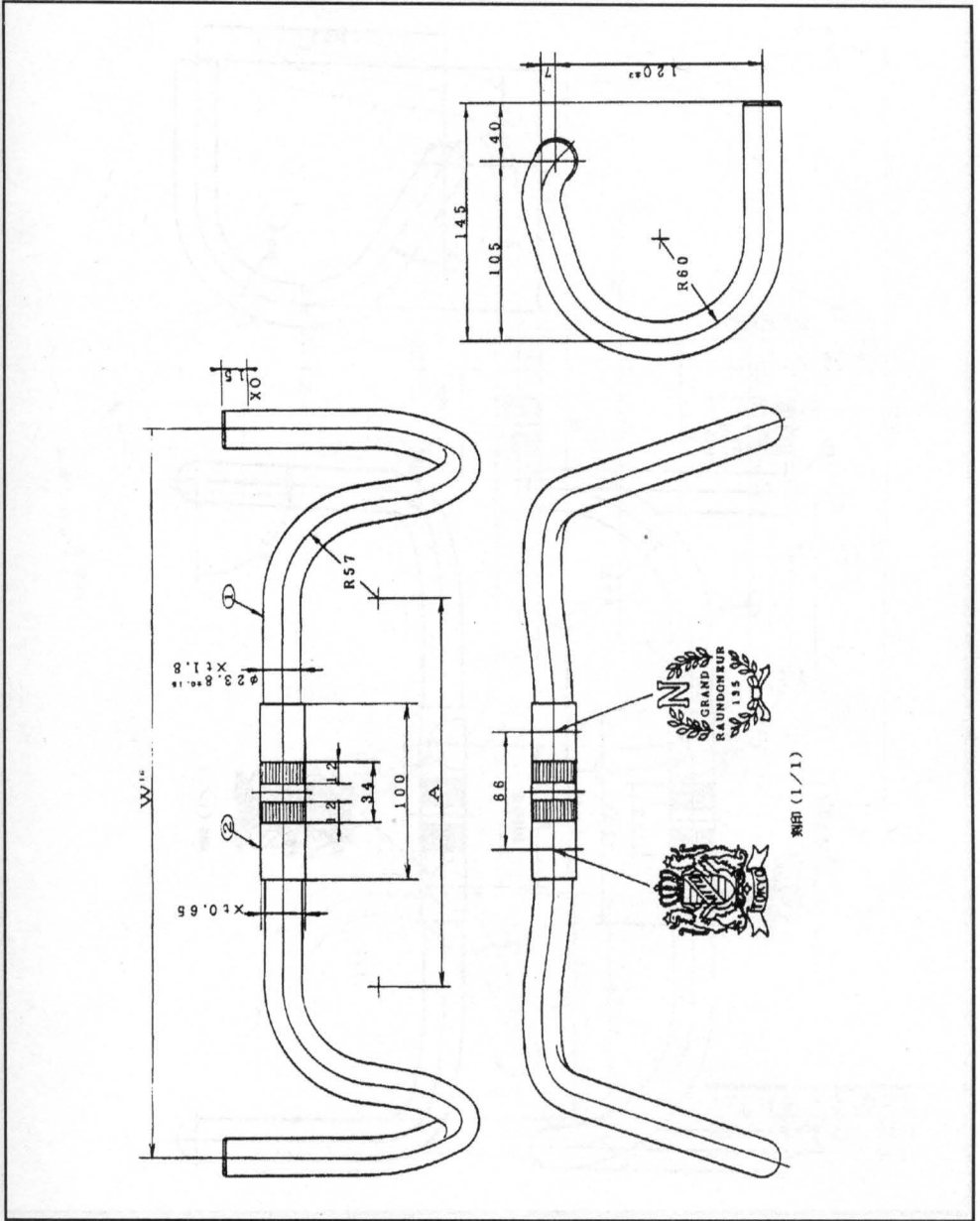

NITTO RANDONNEUR

Randonneur bars originated in France, and came as standard equipment on lots of the touring bikes sold here in the '70s. The upper portion is gently sway-backed, leading to little hand-supporting humps behind the brake levers. The drop is shallow, and the ends flare slightly. Ours are 42cm wide to the center of the curve, and 45cm wide at the ends. That's wider than the randonneur bars of old, and generally better for keeping a heavy, loaded bike under control. A nice bar, and some riders will ride no other unless forced to.

Weight: 365g. • Sizes available: 45mm-ø26.0

ITEM# 16-036

MEMBER PRICE \$42

NON-MEMBER \$45

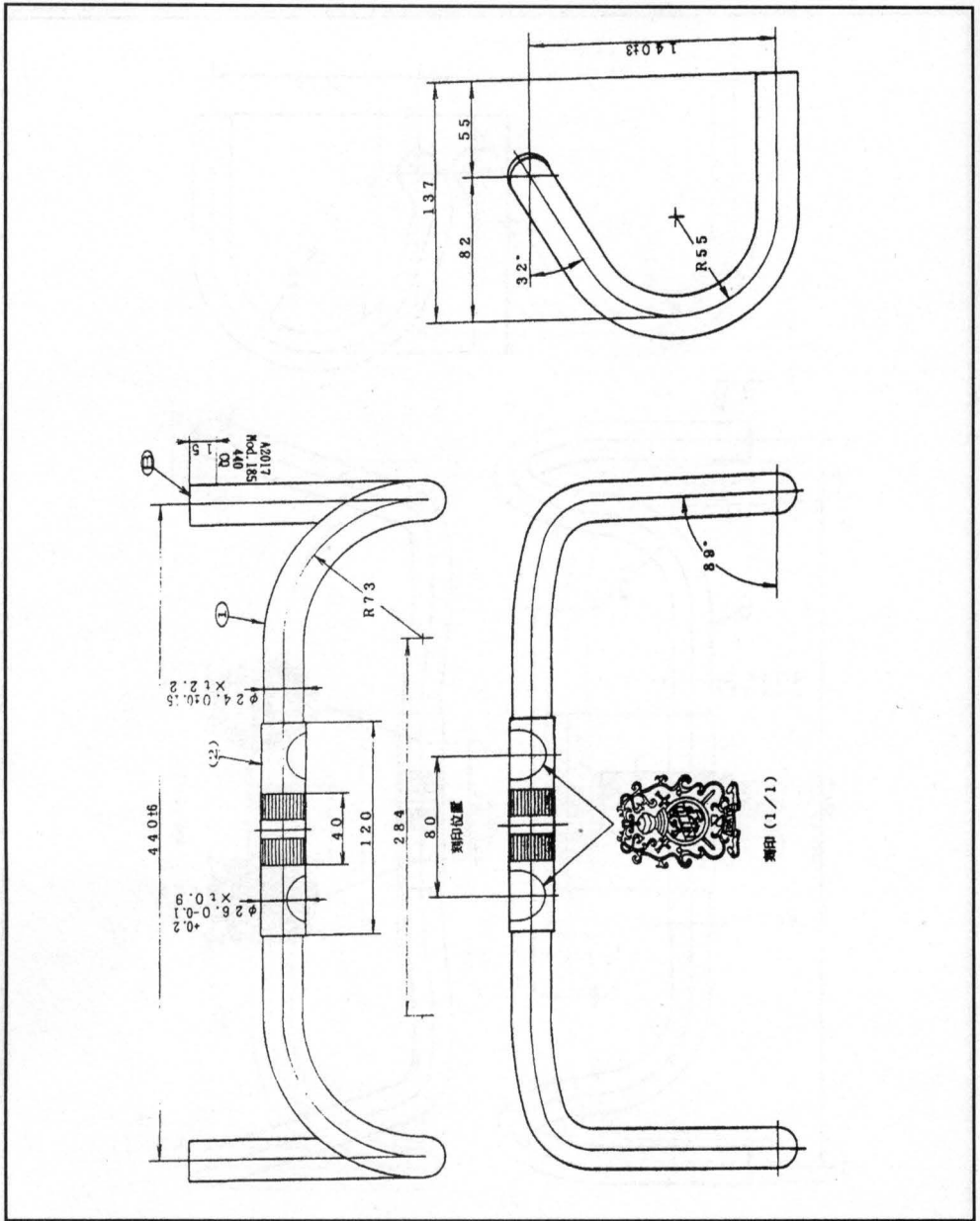

NITTO MOD 185

An excellent all-round road bar. Has the shortest reach of any we offer, and a shallow to medium drop (140mm). Our most popular model of the pre-Dream Bar years, and still a great choice, but these days we carry it in the 40cm width only, since Dream bars are taking most of the other sales. This is a good bar in all widths, but we sell so few 40cm bars, and this one has the shortest reach of any bar, so it makes the most sense in that width. Rotate them upward about 10 degrees.

Weight(40cm): 310g.

Sizes available: 40cm

| | |
|---------------------|------|
| ITEM# 16-023 | |
| MEMBER PRICE | \$40 |
| NON-MEMBER | \$42 |

MORE HANDLEBARS

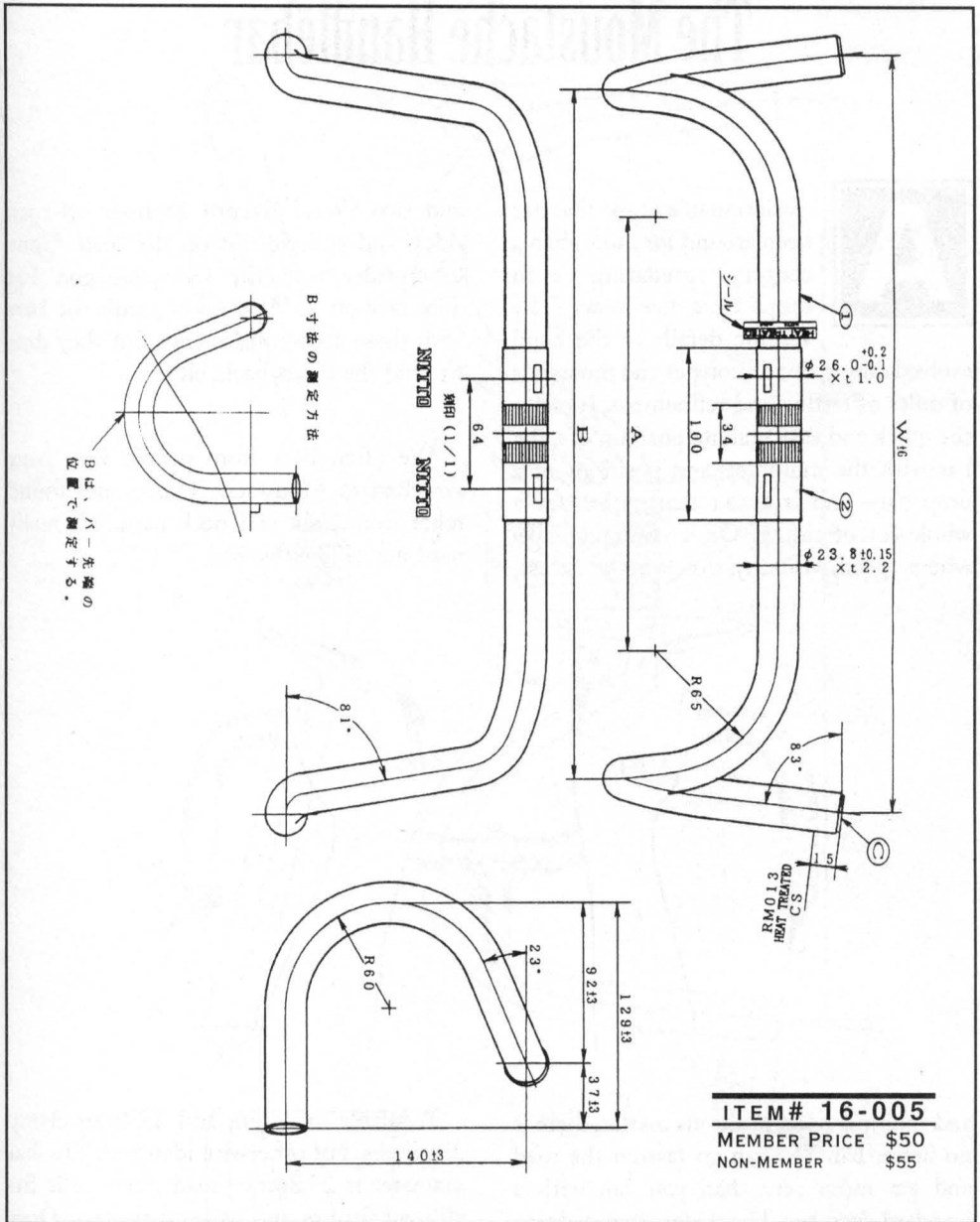

NITTO DIRTDROP/TANDEM

A wide, strong bar perfect for controlling a loaded bike or tandem. And furthermore, it's good for unloaded singles, too. Wide bars lighten steering by offering more leverage, and many of our customers, after riding this one, won't even go back to 44cm bars. A 7-degree flare increases wrist clearance, important for climbing hills in the drops. The flare is subtle, so the brake levers stay vertical.

Don't compare the width of this bar to other bars; not the same way, at least. This one flares 7-degrees, so the end-to-end winds up at a whopping 52cm. But the more important width is at the center of the curve, about where the brake levers go, and it's just 48cm wide there. Still wide enough, but not so wide that anybody you ride with will notice. But you'll feel the difference whenever you ride a bike with narrow bars. It'll be a relief to get back onto these.

The Moustache Handlebar

A

variation of a shape that has been around for more than a century, predating even drops by a few years. The specific details of the bend evolved during five prototypes and thousands of miles of testing and refinement. It offers the quick and easy braking position of a flat bar with the multiple hand positions of a drop bar—and is better than either for a whole lot of riding. On a commute bike where speed, visibility, quick brake access,

and two World Record 24-hour off-road rides, and still rides it on the road. Gene Oberpriller won the Chequamegon Fat Tire race on it. We'd never credit the bars with these accomplishments, but they didn't hold the riders back, either.

We often hear from people who have switched to Moustache H'bars and found relief from back and neck pain. It's really hard not to like this bar.

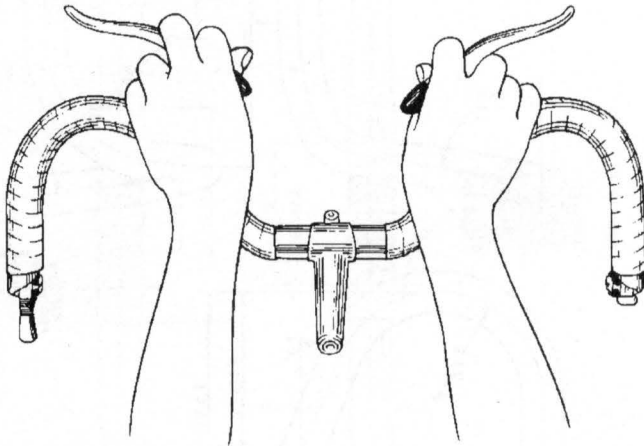

and multiple hand positions matter, there is no better bar. You can go fast on the road and get more aero than you can with a standard drop bar. The wider-than-a-drop-bar grip helps you to pull up steep climbs and stay in control on bumpy sprints. You can ride the Moustache Handlebar off road and reach the brakes instantly, just as you can with a straight bar.

It's our favorite mountain bike bar, but we aren't the only ones who like it. John Stamstad rode it to victory in two Iditabikes

Available in 26mm and 25.4mm clamp diameters, but otherwise identical. The bar diameter is 23.8mm—road size—so it fits all road fittings and bar-end shifters. Does not fit thumbshifters or normal mountain-bike stuff. Heat-treated 2014 T6 aluminum, suitable for off-road riding as well. Tip: Most people, switching from drops to Moustache H'bars, prefer a stem about 3cm to 4cm shorter.

Weight: 346g.

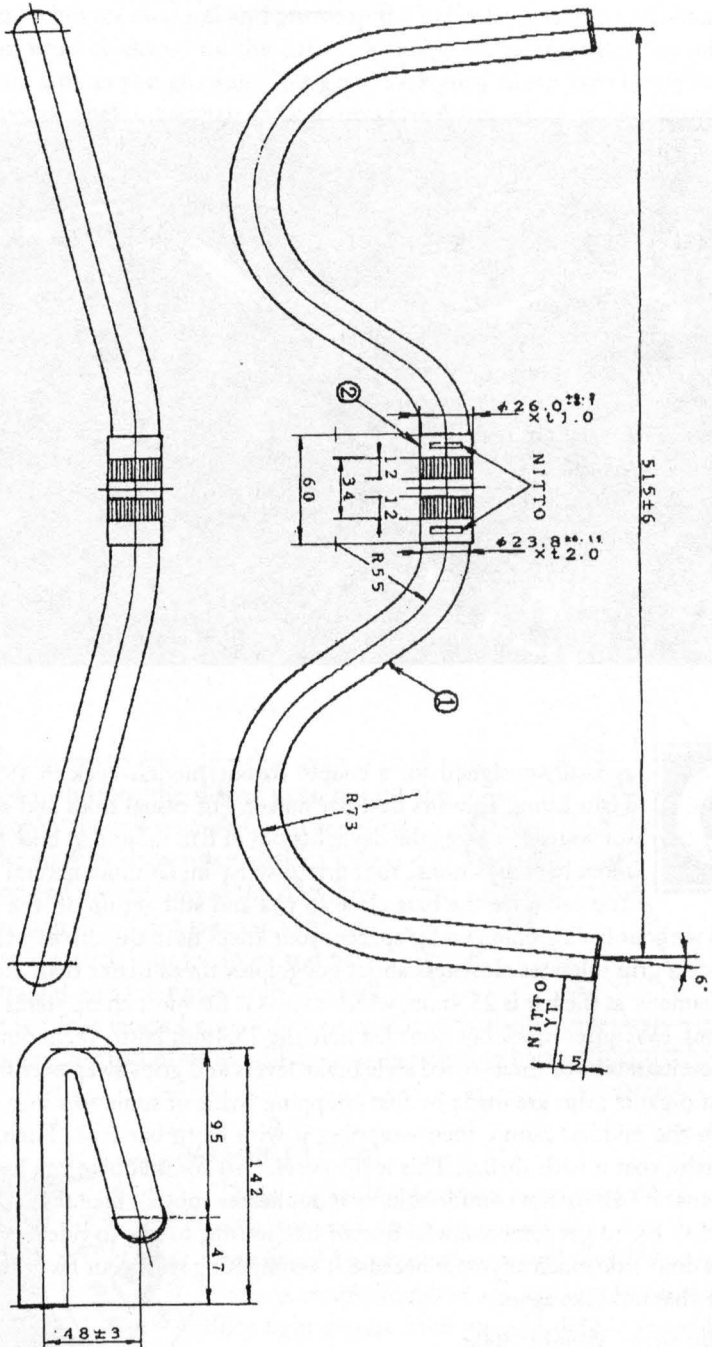

| 26 MM | | 25.4 MM | |
|---------------------|------|---------------------|------|
| ITEM# 16-028 | | ITEM# 16-027 | |
| MEMBER PRICE | \$50 | MEMBER PRICE | \$50 |
| NON-MEMBER | \$55 | NON-MEMBER | \$55 |

The Priest Bar



originally designed for a couple Bstone models back in 1992, and made by Hsin Lung, Taiwan's best bar maker. For casual rides and short trips, or just for a break, it beats the daylights out of flat, mountain bike style bars. You get more hand positions. Your grip is wrist-in, far more natural and comfortable.

You can have the bars close to you and still get up off the saddle and pedal up a hill without feeling cramped for space—your knees fit in the curves without hitting, and the wrist-in grip tolerates closeness about googolplex times better than does a flat bar. The clamp diameter at the bar is 25.4mm, which means it fits most cheap stems and all mountain bike stems. (We often stock but don't list here the 25.4mm Nitto Technomic. If you want it, ask.) Mountain bike or three-speed style brake levers and grips swap over fine, too, although the most organic grips are made by first wrapping twine of some sort into a double-tapered (fatter in the middle) hump, then wrapping it with cloth bar tape. Then, if you're feeling extra earthy, coat it with shellac. This is the perfect bar for that bike you have that you never ride because it's either not comfortable, or it duplicates another bike that you ride a lot more. The perfect bar to get someone who doesn't like to ride, to like to ride again. If you've got a bike you don't ride much anymore because it's competing with your favorite, rig it with these and love that old bike again.

Width: 54cm. Weight: 360g.

ITEM# 16-056

MEMBER PRICE \$18
NON-MEMBER \$22

HANDLEBAR EXTRAS

FRENCH COTTON BAR TAPE

Thick, textured cotton, woven especially for wrapping bicycle handlebars, and unchanged for years. Cut two inches off each roll and pre-wrap the brake lever clamp area. Start at the bottom of the bar, wrap clockwise on the left, c-clockwise on the right, or the other way around. Wiggle the tape as you go, watch for gaps. Wrapping damp tape (spray water!) is easier than dry tape, as it helps it stretch and conform better around the curves. If you're new to cloth tape, buy an extra roll or two, because you're sure to miscalculate the amount of overlap (about 1/4 to 1/4 the width) and end up short.

| COLOR | ITEM# |
|---------|--------|
| Black | 16-068 |
| Blue | 16-069 |
| Green | 16-071 |
| Lt Blue | 16-076 |
| Orange | 16-072 |
| Red | 16-073 |
| White | 16-074 |
| Yellow | 16-075 |

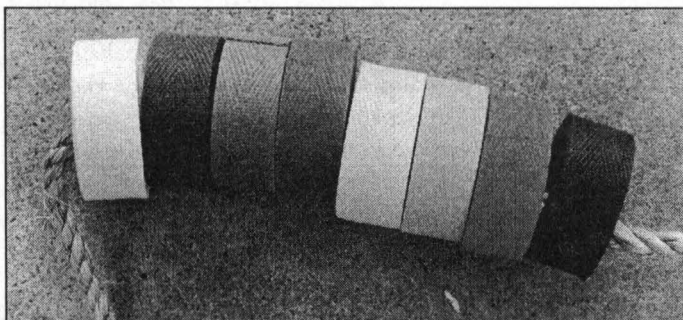

from left: white, blue, light blue, green, yellow, orange, red, black.

| | |
|--------------|-----|
| MEMBER PRICE | \$3 |
| NON-MEMBER | \$4 |

HEMP TWINE

This is the classiest way to dress up a fine wrap of cloth tape. Starting about 3/4-inch from the sleeve, wrap toward the stem, and when you're about 4 wraps from the edge of the bar sleeve, take another short piece, make a loop of it, point the loop end inward toward the stem, and do the last 4 wraps over this. Then take the loose end of the wrapping twine, stick it in the loop, and have a friend hold it straight, not too tight, while you pull it back under the last four wraps. Leave it raw, or coat it with shellac, or Elmer's wood glue. One ball of twine will do seventy or eighty bars.

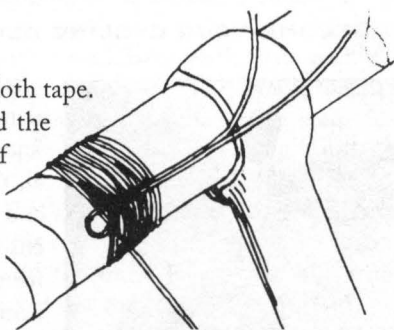

| | |
|--------------|--------|
| ITEM# | 16-086 |
| MEMBER PRICE | \$5 |
| NON-MEMBER | \$6 |

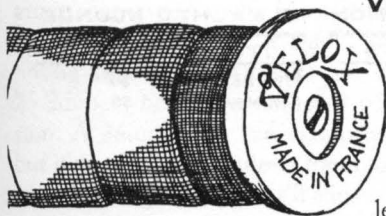

VELOX PLUGS

These are no longer being made, and when we heard that, we shut down operations for a month to search the world for whatever we could find. What we found were a couple hundred blacks, and two hundred and fifty light greens, then we sold the blacks, so all that's left is green. When those are gone, it'll be wine corks or chromed plastic, and you can guess which ones we'll be rooting for. In the meantime, we are proud and sad to present to you the last real Man's and real Woman's handlebar plugs we could get our mitts on.

GREEN

| | |
|--------------|--------|
| ITEM# | 16-079 |
| MEMBER PRICE | \$6 |
| NON-MEMBER | \$9 |

RIVENDELL BICYCLE WORKS

SHELLAC

This is all you need to convince your cycling beyond a shadow of a doubt, that Rivendell is having a bad influence on you. The thing is, shellacked handlebars are beautiful beyond words, and you can get colors and shades and textures that are unique and unduplicable in the world of foamette bar wraps and logotapes. Coats of amber shellac over yellow cotton gives a baseball mit brown color that's almost a perfect match for the Honey brown B.17. Four coats over white gives a chocolate brown. Blonde dewaxed shellac over white gives a creamy, golden yellow. Amber over orange gives burnt orange. There are ways to get olives and golden olives and oxbloods and purples, too, but we'll save that for a Reader story or the next catalogue. If you like fun and aren't too concerned about what your peers think, dive in. You also need a water bottle or a can of some sort; a brush—get a 49-cent Taiwanese or Malaysian boar's bristle brush at your hardware store. Instructions included. Enough for maybe 4 to 5 bars.

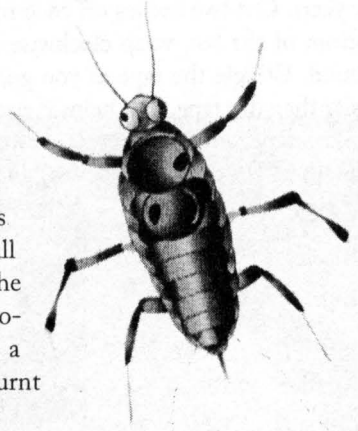

BECOME YOUR CYCLING CLUB'S CLIFF CLAVEN. TELL 'EM...

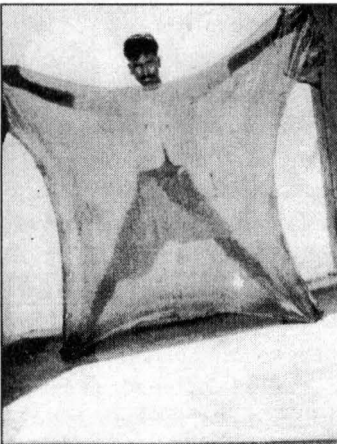

Native "Bhilwaya" completes the stretching job

Shellac comes from lac bugs, which live chiefly in India (land of the Taj Mahal). Latin scholars and entomologists know them as *laccifer lacca*. After a shameless mating ritual, the glowing females alight onto trees, bite said trees, and ooze out this mess through their pores. It then hardens into a shell which serves as an egg/cocoon/incubator for baby lac bugs. In time they hatch and leave the shell behind on the branches. Minimum wage workers then scrape them off, snap their fingers, and the next thing you know, it's neatly packaged in plastic ziplock bags here at Rivendell. More details in a future *Reader* article.

NATURAL/CINNAMON

ITEM# 16-059

MEMBER PRICE \$8
NON-MEMBER \$9

BLEACHED BLONDE

ITEM# 16-061

MEMBER PRICE \$7
NON-MEMBER \$8

Stems



n ugly stem on an otherwise nice bike is like cheap, promotional baseball-type cap on Audrey Hepburn. It's so unnecessary.

It's easy enough to find a stem with the right dimensions, so once that's done, why not put something on your bike that's nice to look at? It's right there under your nose, after all, so you'll see a lot of it.

Twenty years ago there were no ugly stems. Even cheapies had their charm, and what they lacked in finish work and polish, they at least made up for in simplicity and balanced proportions. These days, you can spend \$200 on a stem and get something so heinous looking it shouldn't even be ridden during the day. Nighttime Specials!

Stems shouldn't be too fat. They shouldn't have logos on them, but we'll allow the Pepper Guy on Salsas, since he's been a fixture forever, and we'd hate to see him go..

The clamp should fit the bars. Most road handlebars have 26mm center sections. Traditional Cinellis are 26.4mm, so you can use only a Cinelli stem. Cinelli has started making some in 26mm, though, so there's hope there. Another famous Italian maker, 3ttt ("Triple-T") is now owned by the same group that owns Cinelli. Most 3ttt stems fit 26mm bars, although it might be worth noting that lately 3ttt bars are closer to 25.8mm, a heretofore unheard of dimension. A 26mm stem can clamp onto that, but if quality control allows them to wander into the 25.7mm range, it'll slip.

As far as we know, the other high quality road bars, from Specialized, Ritchey, Italmanubri, Profile, Scott, and Marge Schott all fit 26mm stems.

On road bikes, we prefer stem angles between 70 and 75 degrees, because when you look at them from the side, they seem to flow into the curve of the handlebar. It looks good. Stem extensions always look best when they seem to flow into the bars.

We sell tons of stems to riders who want the bars higher. Nobody ever wants them lower. When you raise the stem, the bar comes closer to you. On a bike with a 73.5-degree head tube, for example, raising the bars 4cm will bring them back about 1.5cm.

But that's not all! Because the bars are higher, they're also closer. This would be true even if your head tube angle were 90-degrees, and the bars came straight up.

Even that's not all! As the bars come up, your arms reach out to them more horizontally; and the more horizontal your arms, the farther out they reach. See page 18.

We have a better-than-average selection of long-quill stems with 26mm clamps, and probably not a day goes by when we don't sell at least two or three stems to riders who've tired of riding their bars too low and have finally decided to get them up. Raising your handlebars an inch or two or sometimes three will do wonders for aching backs, sore-to-numb hands, and stiff necks. It's the single most comfort-increasing change you can make on your bicycle.

Lugged Stems In General, Ours In Particular



ugged stems aren't popular for the same reason lugged frames aren't: They cost too much to make; they're a hassle, and nobody's demanding them. But it wasn't always like that. The French made lugged stems in the late '40s, and surely they weren't the first. But aluminum casting and forging took over, and for a long time there you could get aluminum stems that had fake lugs cast into them. Now even these are gone.

The most recent inspirations have been from Japan. There and for many years, small custom builders have made their own lugged stems. The ones we've seen were on modern, one-off, French-replica bikes. There's a lot of that going on over there.

Those of you who have been customers since 1995 or so know we've been aching for our own lugged stem for that long, at least. We've alluded to it, sold gift certificates to raise the tooling dough, and now we have it, sort of.

What we have (July 1999) are about 23 prototypes. Half of them have been tested, for both fatigue and impact. They're exceptionally strong.

The next step is getting them plated, probably with nickel. Plating can be tricky, and it's not easy to find a good plater who can simultaneously comply with strict environmental standards for this potentially dark brown process, and lay a thin, durable, consistent layer of metal over the steel.

The sure way to guarantee we'll have plating problems is to promise delivery by August 1, but whether the jinx factor kicks in with that as merely a target date remains to be seen. We'll keep you posted in the RR.

HERE ARE SOME FACTS:

1. **Lugs:** Investment cast steel. Taiwan!
2. **Tubing:** custom Reynolds 853. The extension is 25.4mm x 0.8mm. The quill is a special, pain-in-the-neck-to-make tube with a 25.4mm x 1.5mm upper section that is swaged down to the 22.2mm size required by steer tubes. During the swaging, the 1.5mm wall grows to 1.7mm.
3. **Clamp diameter:** 26mm. It will not fit 26.4mm Cinelli bars.
4. **Quill length:** 160mm. That's an inch taller than a standard Cinelli/3ttt stem quill. Theoretically it is possible and even easy to make any length quill (or extension, for that matter), and in time we may. But the first launch is with 160mm quills
5. **Angle:** 73.5 degrees.
6. **Extensions:** 80mm through 130mm.
7. **Bolt material:** Steel at least. Maybe a Ti one later, after we're sure of the strength.
8. **Weight:** 370g (10cm)—about the same as a cold-forged aluminum stem. A Ti bolt will take off another 30g or so.
9. **Paint options?** Not yet. Everyone's asking for it, but at first we're going with plating. It's more durable and goes with everything.
10. **Price:** \$175.

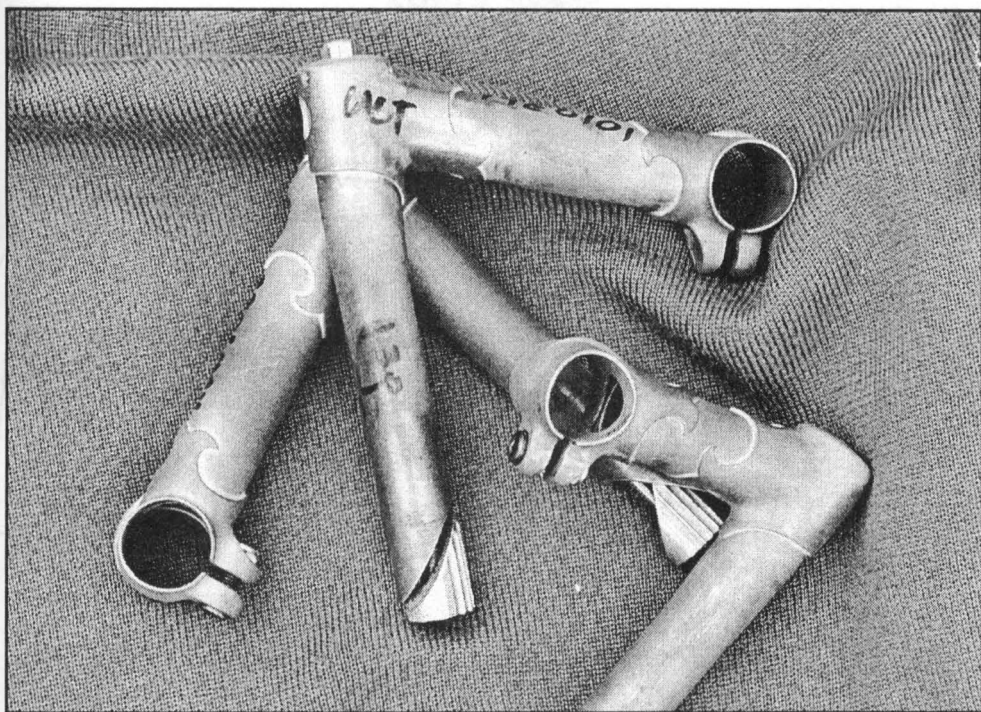

Test samples (already tested) and stem lugs. If you look closely at the stem quills, you'll notice the slight bulge as the quill diameter changes from the 22.2mm (7/8-inch) required to fit into a steerer, to 25.4mm (1-inch) which we wanted at the joint, for greater strength. These stems are raw, unplated. The real ones will be shiny.

TESTING

The Consumer Products Safety Commission (CPSC) requires the stem be tested for impact strength, in which the stem quill is clamped in a fixture at its maximum extension, and a high force blow is applied at a 45-degree angle, which is presumably the angle of most leverage. A more important test is the fatigue test. This isn't a CPSC test, but it simulates real life use more. In the fatigue test, a fake handlebar was clamped, and the stems were subject to a slightly rocking up and down force of 200 lbs. This is a many times greater force than you'd ever apply in actual riding conditions. The lab that tested our stems regards any stem that reaches 50,000 cycles as safe. Our stems averaged around 200,000 cycles, and went as high as 404,000.



Curt messing with a first-generation fork jig.

Nitto Pearl

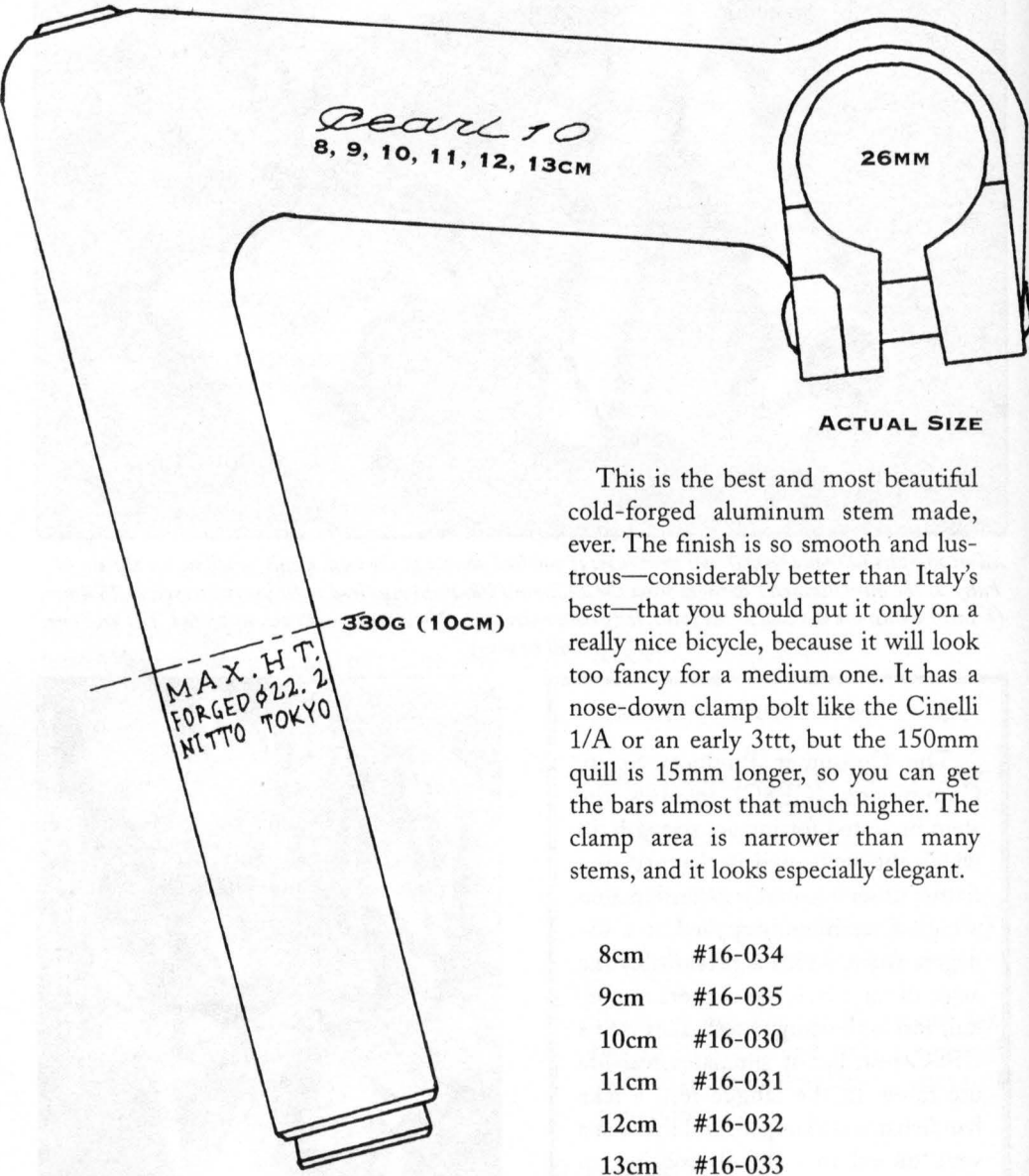

ACTUAL SIZE

This is the best and most beautiful cold-forged aluminum stem made, ever. The finish is so smooth and lustrous—considerably better than Italy's best—that you should put it only on a really nice bicycle, because it will look too fancy for a medium one. It has a nose-down clamp bolt like the Cinelli 1/A or an early 3ttt, but the 150mm quill is 15mm longer, so you can get the bars almost that much higher. The clamp area is narrower than many stems, and it looks especially elegant.

- 8cm #16-034
- 9cm #16-035
- 10cm #16-030
- 11cm #16-031
- 12cm #16-032
- 13cm #16-033

| ITEM# | SEE SIZES |
|--------------|-----------|
| MEMBER PRICE | \$45 |
| NON-MEMBER | \$49 |

Nitto Aero

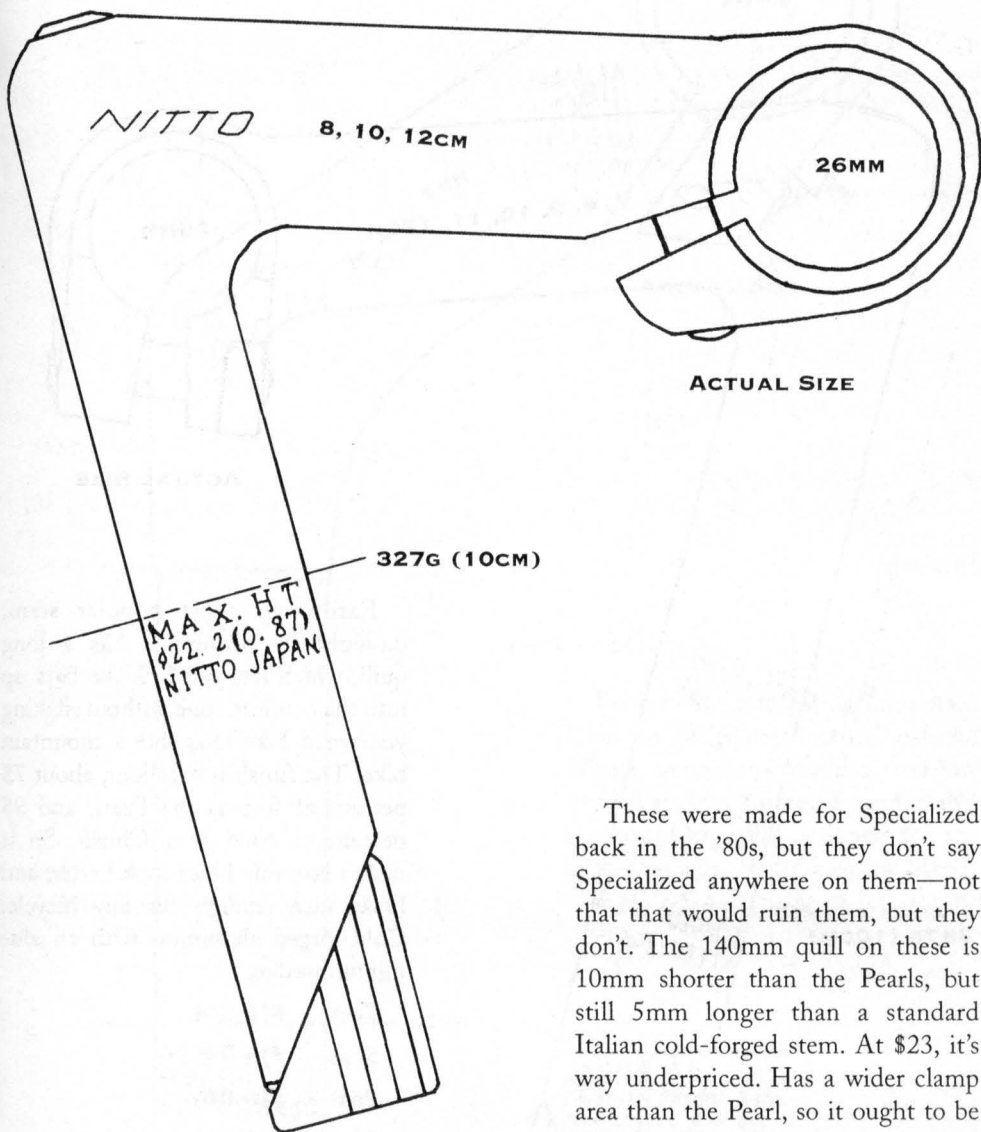

These were made for Specialized back in the '80s, but they don't say Specialized anywhere on them—not that that would ruin them, but they don't. The 140mm quill on these is 10mm shorter than the Pearls, but still 5mm longer than a standard Italian cold-forged stem. At \$23, it's way underpriced. Has a wider clamp area than the Pearl, so it ought to be slightly stiffer, if that matters.

- 8cm #16-011
- 10cm #16-009
- 12cm #16-010

| ITEM# | SEE SIZES |
|--------------|-----------|
| MEMBER PRICE | \$23 |
| NON-MEMBER | \$25 |

RIVENDELL BICYCLE WORKS

Nitto Technomic Deluxe

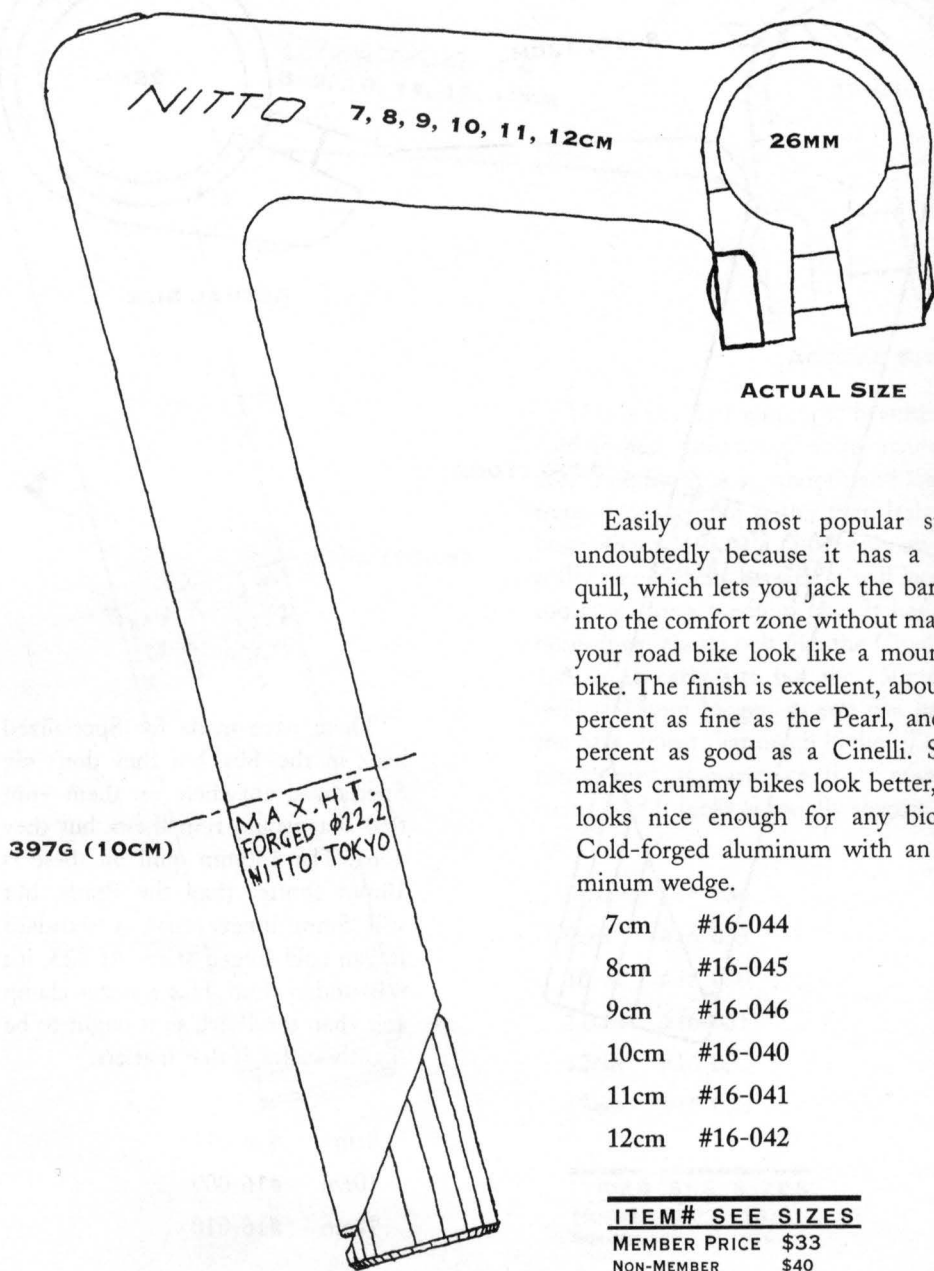

Easily our most popular stem, undoubtedly because it has a long quill, which lets you jack the bars up into the comfort zone without making your road bike look like a mountain bike. The finish is excellent, about 75 percent as fine as the Pearl, and 95 percent as good as a Cinelli. So it makes crummy bikes look better, and looks nice enough for any bicycle. Cold-forged aluminum with an aluminum wedge.

| | |
|------|---------|
| 7cm | #16-044 |
| 8cm | #16-045 |
| 9cm | #16-046 |
| 10cm | #16-040 |
| 11cm | #16-041 |
| 12cm | #16-042 |

| ITEM# | SEE SIZES |
|--------------|-----------|
| MEMBER PRICE | \$33 |
| NON-MEMBER | \$40 |

Nitto DirtDrop

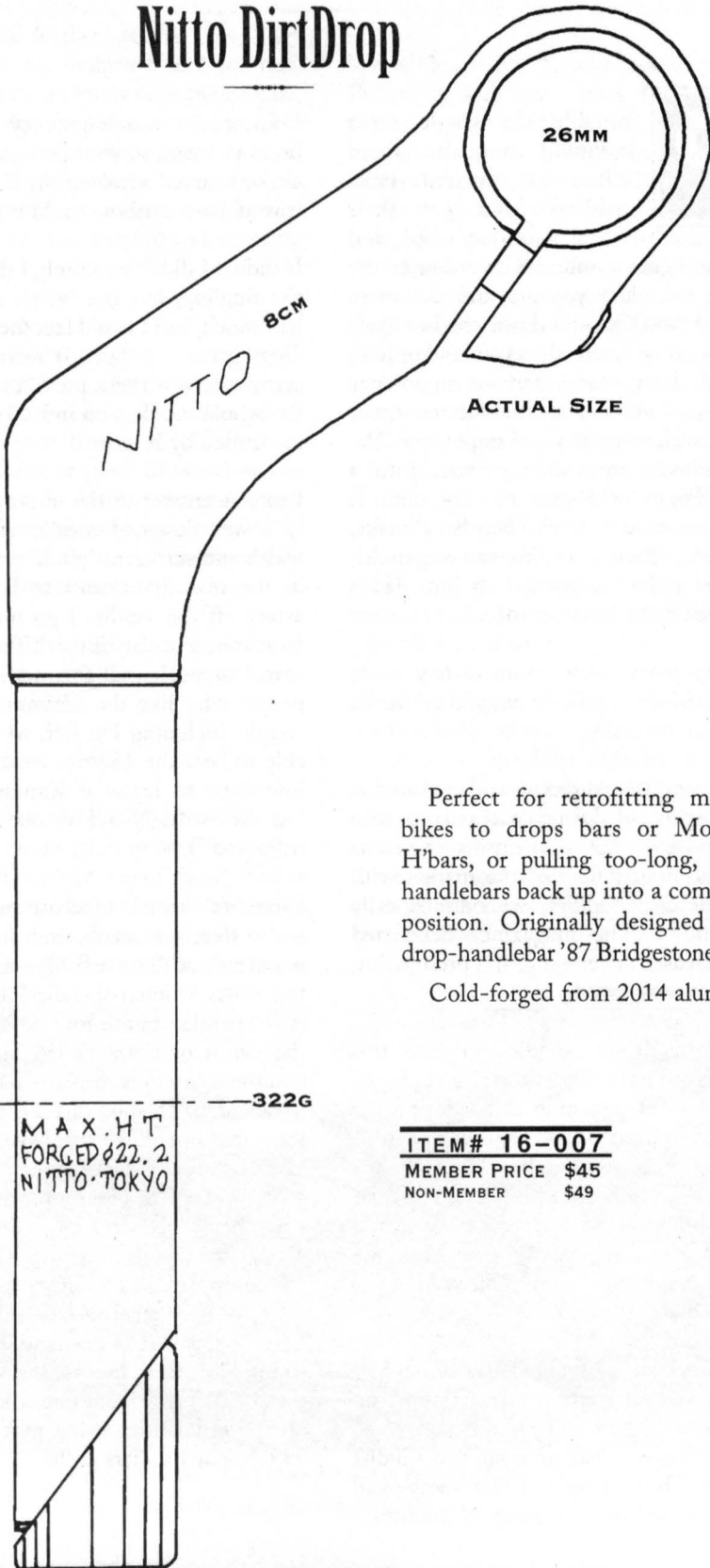

Perfect for retrofitting mountain bikes to drops bars or Moustache H'bars, or pulling too-long, too-low handlebars back up into a comfortable position. Originally designed for the drop-handlebar '87 Bridgestone MB-1.

Cold-forged from 2014 aluminum.

MAX. HT
FORGED ϕ 22.2
NITTO-TOKYO

322G

ITEM# 16-007
MEMBER PRICE \$45
NON-MEMBER \$49

Saddles & Related Items



robably the single most common complaint about bikes is uncomfortable saddles. Men get their penile artery squished, and their penis goes numb, and according to the experts, the older you are and the more frequently you squash it down, the less likely it is to open up again when you kind of wish it would. Last year a famous impotency doctor went public with the statement that cycling is a leading cause of impotency. The bike industry immediately went into a panic. "Poppycock!" was the cry, and "It hasn't happened to me!" Then Ed Pavelka, at the time a Bicycling editor and megamiler, admitted it had happened to him. (He's recovered, is the latest word).

The impotency doctor immediately made the rounds of the talk shows, and all media covered it, naturally.

The bike industry shrieked, and panicked at the prospect of losing participants and scaring off new ones, but many manufacturers and opportunists flooded the market with anti-impotency saddles, with strategically placed holes. The magazines benefitted from increased advertising, and presumably, marriages were saved.

Where do Brooks saddles fit into this equation? That's the question I asked myself. I don't go numb at all during my normal rides, but in the days when I rode rollers a lot, I got numb a lot. (I hadn't riding a B.17, however.) The acid test for penile numbness is always rollers (or wind trainers), so I excavated mine from the garage, brushed the cobwebs off, got out the stopwatch and got on the bike.

In the old days, I'd go numb after about half an hour, and after an hour I'd be numb up to my navel. I hate rollers and trainers, so this time I gave it half an hour, and I didn't go numb. The first signs of numbness—call it tingling—set in after about 38 minutes.

I know the anti-impotency saddles have holes in them, so your penis artery rests on air, so I carved a hole in my B.17. I thought it would work—how could it not?

It didn't. I didn't go numb, I didn't even get the tingling, but the saddle sagged like a hammock, and I could feel the saddle frame digging into my butt. It seems the leather across the top there provides structure for the whole saddle, and indeed this was later confirmed by Brooks.

Brooks's answer to the impotency problem is a well-designed saddle with sufficient width and sufficient "pitch"—the slight rise in the rear that seems to lift your penis artery off the saddle. I go numb on some Brookses, but anything 170mm or wider seems to work well for me. I know many people who like the 160mm wide Pro. A couple, including Pal Jeff, who seem to be able to bear the 152mm wide Swift. I'd be interested to know if Kansas megamilers like the Swift. ("Send me one free—I'll test it for you!")

Women's ischial tuberosities are spaced wider than are men's, and although most women do well on a B.17, some still prefer the wider women-specific jobs. The issue isn't penile numbness and impotency (believe it or not); it's crushing the folds, and the solution is similar—a big hole right smack dab. It shouldn't be a surprise to learn that not all women have their folds in exactly the same place, which explains why some women are a lot more sensitive to bike seats than others are.

The only Brooks model we list here is the B.17, in both steel and titanium rails. We have several others on hand, but sell them so infrequently: The Pro, the Women's Pro, the B.72...if you want one, ask or just put it on the order form using part number 99-999. Seventy dollars each.

⌘ SADDLES ⌘

Brooks saddles are made by hand, and that means there are slight differences from saddle to saddle. In the B.17, for instance, the skiving (shaved leather) at the lower edge varies. There's no foolproof tool for this, and doing the entire lower edge in one pass, keeping the edge the same width its whole length, is impossible for mere mortals. Sometimes the tool slips off or dives into the leather, and the cut isn't made in one pass. You can see the starting and stopping points.

That's not a defect.

One of our members, a leatherworker, says you should rub beeswax into the skived lower edge of your Brooks saddle. Burnish it in with a horn or piece of wood or cap from a Bic pen. It darkens the pores and seals them from sucking up water. Why miss any opportunity to rub beeswax into leather? Talk about heaven!

Some Brookses have drooping eyelids that partly cover the saddlebag loops. Carve them up with a knife.

That's not a defect, either.

Once in a rare while, the saddles are cockeyed too much (they're often cockeyed acceptably). If you get one of those, send it back with a note. The charm of hand made is one thing, but we don't want you riding around on a lopsided saddle, thinking

they're all that way, not being happy! Nineteen in twenty Brooks saddles are virtually perfect, and we sort before sending.

We sell about 360 Brooks saddles per year. I'm pretty sure that makes us Brooks' top dealer, at least in the United States. That's not saying much, though, because so few dealers even sell Brooks saddles. I don't get it—is it because they aren't supported by tons of advertising? Is it because people don't know what to make of a leather saddle, or have heard rumors about them taking a long time to break in? They don't take long at all; maybe a hundred miles, that's all. It can't be the cost, because there are plenty of saddles in the same \$70 to \$140 price range (although, if you're perfectly comfortable on a \$25 plastic saddle, why pop for more?). Is it the weight? A steel-railed leather saddle typically weighs about 3-4 ounces more than its equivalent plastic saddle, so what's going on there? We'd rather sacrifice comfort and ride on a piece of plastic, all for a psychological advantage?

Brooks is a good company. It makes great saddles. With all the high-tech shenanigans going on in the bike industry, I think if Brooks were a new company, it wouldn't get off the ground. So the only explanation as to why it continues to make saddles is that there are too many cyclists out there already, who know the truth and keep Brooks alive.

—Grant

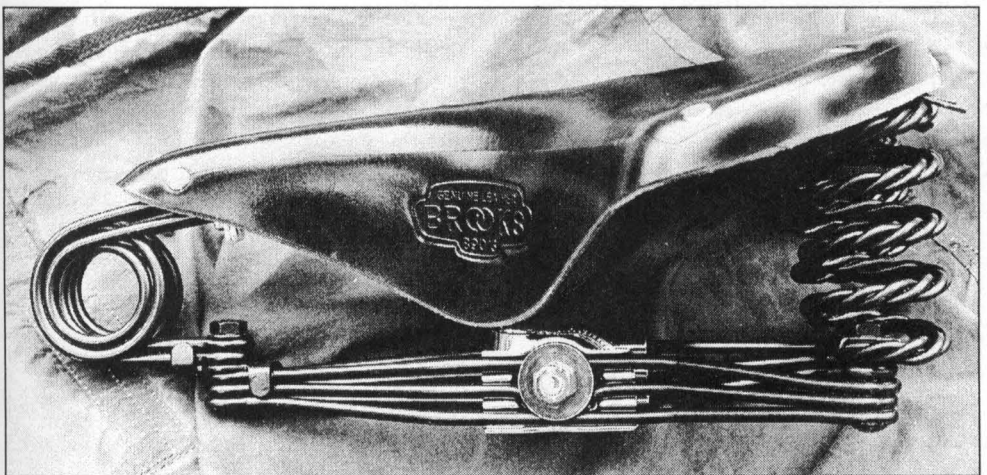

*The Brooks B.90/3. As comfortable and as heavy as bike saddles get.
We don't stock it, we can get it. Want it? Ask.*

About That Brooks Saddle...

IT DOES NOT NOT REQUIRE A LONG BREAK-IN PERIOD, during which you'll hurt, bleed, and go numb and impotent. It's shaped right and is pretty comfortable right off the bat. There is some breaking in as the saddle molds itself to your butt, but even a new, hard Brooks will be reasonably comfortable if you set it up right.

Before you mount any new saddle, measure your saddle height from the center of the bottom bracket to the top, where you sit. Brooks saddles are taller than plastic saddles, so when you take off your old saddle and put on a Brooks, you'll have to lower the seat post.

When you hold your Brooks horizontal and look closely, you'll see that the rear portion is 3mm to 5mm higher than the middle (neck) and front (nose). That's called *pitch*, and it's an important feature, because it keeps the pressure off the relatively important area between your anus and genitals.

THE KEYS TO SADDLE COMFORT ARE:

- 1) sufficient width to support your sit bones.
- 2) relatively flat rear portion, for the same reason
- 3) proper pitch to reduce pressure on your perineal region
- 4) a narrow neck, so you don't scrape your thighs.

If you're used to a skinny saddle, you might find a more supportive saddle, like the B.17, slightly uncomfortable at first. If it's at the right height and angle, the discomfort is probably due to your sit bones getting used to the pressure of support. Put up with it for a week or two, and eventually the pressure on the saddle will make small depressions in the rear portion, and from then on you'll be fine.

CARE

A light coating of Proofide once or at most twice a year, topside and bottom. Actually, the guy in the world who has repaired the most Brooks says put it on top, only, and he probably knows, but in my head it makes sense to put it on the bottom, too, so that's what I'll do. In wet weather, cover it with a bonnet or plastic bag. If the elements get to it and your saddle starts to sag or flare, tension the nose. If the sides are really splayed, drill 5 to 6 holes in the lower edge, forward of the seat post and on both sides, then lace the two sides together with a shoe lace.

In last year's catalogue I said that with proper care and no major soakings, you'll probably get 15,000 miles out of your Brooks. Immediately, several customers wrote in claiming twice that, easily. I just like to put a bad spin on things, so you aren't disappointed. Also, there are so many factors that affect the life of your saddle. If you weigh 250 and ride it wet for long miles, bye-bye Brooks. If you insist on soaking it for a day or two in your homemade sardine-and-neatsfoot oil concoction just because the town expert said to, same thing. It's probably best to say that as a natural material, leather is not going to keep its shape as long as scientific plastics. But it looks better, and is far more comfortable, and the cost of a leather saddle is incredibly low, considering the hand work that goes into it. Every fine bicycle, and every sore butt deserves one!

Brooks makes about 20 models. We can order any one of them you like. But over the years the one that works the best for most riders is the B.17.—*Grant*

BIKE SEATS!

STEEL

| |
|---------------------|
| ITEM# 11-006 |
| MEMBER PRICE \$68 |
| NON-MEMBER \$72 |

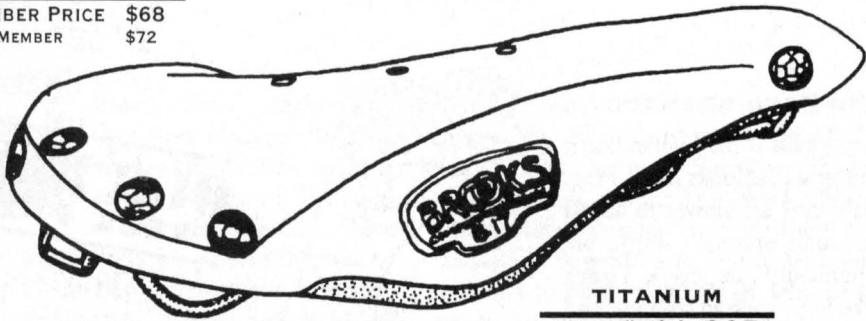

TITANIUM

| |
|---------------------|
| ITEM# 11-007 |
| MEMBER PRICE \$128 |
| NON-MEMBER \$139 |

BROOKS B.17

One of Brooks's older models, much older than the Pro, and for many riders, it's the most comfortable, least genital-numbing saddle out there. Ours is a spiffed up (just for Rivendell) B.17 with thicker leather than the normal B.17, 13mm hand-set copper rivets, and a skived lower edge. Wide enough and flat enough in back to support your sit bones, and shaped right so if you set it up properly with the rear portion slightly higher than the neck, it won't cut off flow to your plumbing or crush your folds. A perfect mate for a Carradice. Two choices: Honey brown with black powder coated rails, about 522g; or medium grey with titanium rails, about 440g.



BROOKS PROOFIDE

Brooks-approved leather dressing for Brooks-approved saddles. One can is all you need for many years.

| |
|---------------------|
| ITEM# 11-005 |
| MEMBER PRICE \$6 |
| NON-MEMBER \$7 |



BROOKS SPANNER (TENSION TOOL)

Cute, compact, chromed. You may ride your Brooks for years and never need to use this, but if you ever want to tension the leather, heaven help you if you're without one, because no normal tool will fit into that tight area.

| |
|---------------------|
| ITEM# 19-013 |
| MEMBER PRICE \$5 |
| NON-MEMBER \$7 |

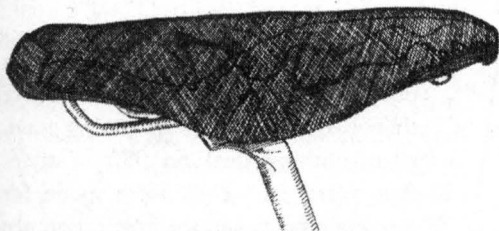

CARRADICE B.17 BONNET

Inspired by shower caps and made of black coated nylon, elastic, with leather reinforcements, this is what you need for super sweaty bottoms and rain rides. Leather-reinforced slots let you thread Carradice straps through it. Paranoid cyclists should place a plastic bag underneath this—not to imply that it isn't totally waterproof by itself, but there is some stitching, so some leakage might happen.

| |
|---------------------|
| ITEM# 11-014 |
| MEMBER PRICE \$15 |
| NON-MEMBER \$18 |

SADDLE PILLARS

NITTO FROG SEAT POST

Nitto calls it the Jaguar, but it from the side it looks like a Frog. Two-bolters are slower to adjust than one-bolters, but are mechanically superior, since they're less prone to slipping and require less tightening force (per bolt) than a single bolt. This one's easier to use, since the bolts are 6mm allens, accessible from underneath. Nitto claims this is the strongest seat post they've ever tested. We try to keep them in stock, but if you want one, please be prepared to wait.

ITEM# 11-016

MEMBER PRICE \$75

NON-MEMBER \$80

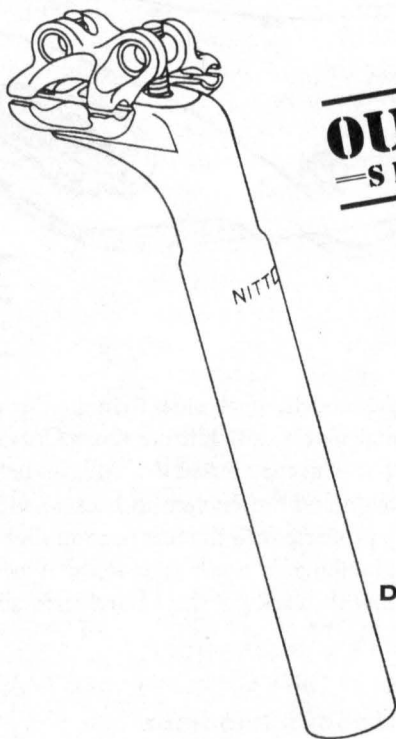

**OUR BEST
SEAT POST**

DIAMETER-27.2 Ø

LENGTH-210MM

WEIGHT-268G

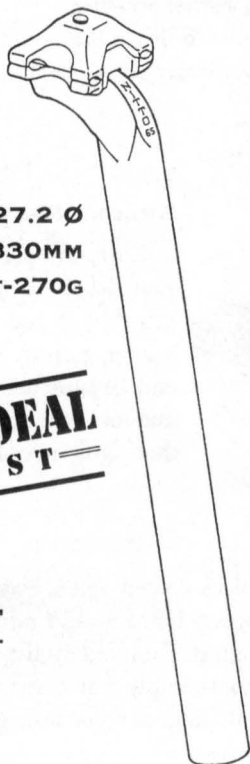

DIAMETER-27.2 Ø

LENGTH-330MM

WEIGHT-270G

**OUR BEST DEAL
SEAT POST**

ITEM# 11-015

MEMBER PRICE \$36

NON-MEMBER \$49

NITTO ONE-BOLT SEAT POST

This post is so strong and so pretty and plenty light enough and so cheap, that you'd have to have some really good reason—like maybe your riding buddy owns another seat post company—for getting any other post.

How can we sell them for \$36, when posts not nearly as good sell for twice that? Because we got a screaming good, all-or-nothing deal on 350 of them four years ago. They were made for mountain bikes, but the only difference between a Nitto mountain post and road post is the length, so if the length bugs you or you want to save 20g, cut some off. Just make sure you have at least 65mm/2.6-inches sticking into your seat tube.

A Case For the Manual Bike

P

Phase One technology increased chances for survival. Things like making stone tools and fire and shelter are Phase One. Once survival was assured, people had the time to develop Phase Two technology—recreation and entertainment things like marbles, harps and tag. Much of today's technology is Phase Three. That's when, now that we've long stopped fretting about survival and grown bored with traditional forms of entertainment and recreation, we invent things that allow us to shut off our brain, grow extra fat, lose coordination and still get by. Things like remote controls, electric pencil sharpeners, and video games are Phase Three. Whether a calculator or a computer art program is Phase Two or Three depends on who's using it, and why. In the early elementary grades, they're definitely Phase Three. If Phase Three totally takes over, future generations won't know how to play tic-tac-toe with chalk on the sidewalk.

I think modern bicycle technology is about Phase 2 3/4. The overriding goal of modern bike parts makers and the bike industry in general, is to make the bike easy to operate, because they think non-cyclists are intimidated by a bike's complications. The industry also knows the same non-cyclists like things that combine a macho facade for a he-man image, with a high tech core for the shortest possible learning curve. Manufacturers see it as following trends and giving people what they want. But when they simultaneously eliminate other alternatives, and their advertising of the new widgets supports the media, the old stuff doesn't stand a chance.

The practice of introducing new things every year is applauded for "growing the sport," and the new things are aimed at those who want to get into fitness-enhancing sports cheap and master them fast. "Mastery" is reduced to figuring out which buttons to push, not how or why or even when to push them. As you read this, millions are being spent on drivetrains that shift by themselves, relieving you of the chore, even, of pushing buttons.

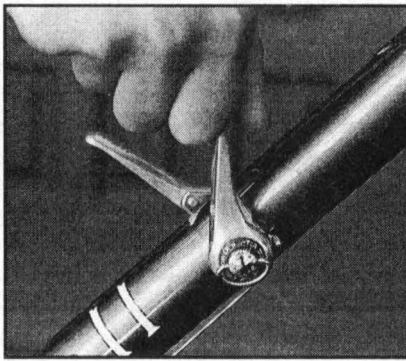

The problem with automatic bikes is that they don't allow you to learn how, so, if you believe that learning is part of the fun, then they aren't as fun. If bikes are just a way to move and get exercise, then that's good enough. But at a certain level, part of the fun of riding is interacting with the bike, and that's

where manual bikes beat the automatics. They sure don't beat them on the sales floor.

The first requirement for a manual bike is a shifter with a friction shift mode. It can index, too, but it's a manual only when it's in the friction mode in the same way that an autofocus camera with the manual override is a manual when it's in manual mode. Most new cyclists don't know what friction shifting is, and among those who do but don't have much experience with it, there's a pervading misconception that friction shifting is unnecessary at best, and requires timing, sensitivity, and years of experience to master; and is therefore outdated. Not so! Friction shifting is easier than tying shoelaces, and takes one one-hundredth as long to master.

The second requirement for a manual bike is a frame and fork with no moving parts to "take the edge off." (We're not ragging on

suspension here; we're just defining "manual bike.") There's a notion that comfort must come from without; but a good position on the bike allows you to relax and soak up shocks unconsciously. Good technique, such as lifting your butt off the saddle when you're going over bumps, helps even more.

Suspension has its place. If you race against other riders who use suspension, then you'll be handicapped without it. But if thrills and fun are your goals, the manual bike is at least its equal, and certainly a less alien sight on a quiet mountain trail (leave your neon advertising riding jersey at home, too). If you define thrills as something like riding at the edge of control without panic, then you can do it just as well, but more slowly, on a manual bike. And, since you're riding 1-2 mph slower (it won't be more than this), the thrills and fun last longer. As a bonus, any crash you do suffer will be at a lower speed.

Not a bad tradeoff!

In bicycle marketing, racers are put on a pedestal, and anybody who doesn't race is encouraged to revere and emulate those who do. Racing used to improve the breed, but now that racing has become more specialized, racing bikes have mutated into weirder and weirder forms that often have no benefits at all for the non-racer.

Manual bikes are simple and good. Not just mechanically, but to operate, too. Nobody is holier for riding one, and we aren't on a mission to convert experienced riders who already know what they like. The point we're trying to make is that manual bikes are easy, and they involve you more, and when so many other widgets in your life are Phase 3, a Phase 2 bicycle can be a good thing.

—Grant

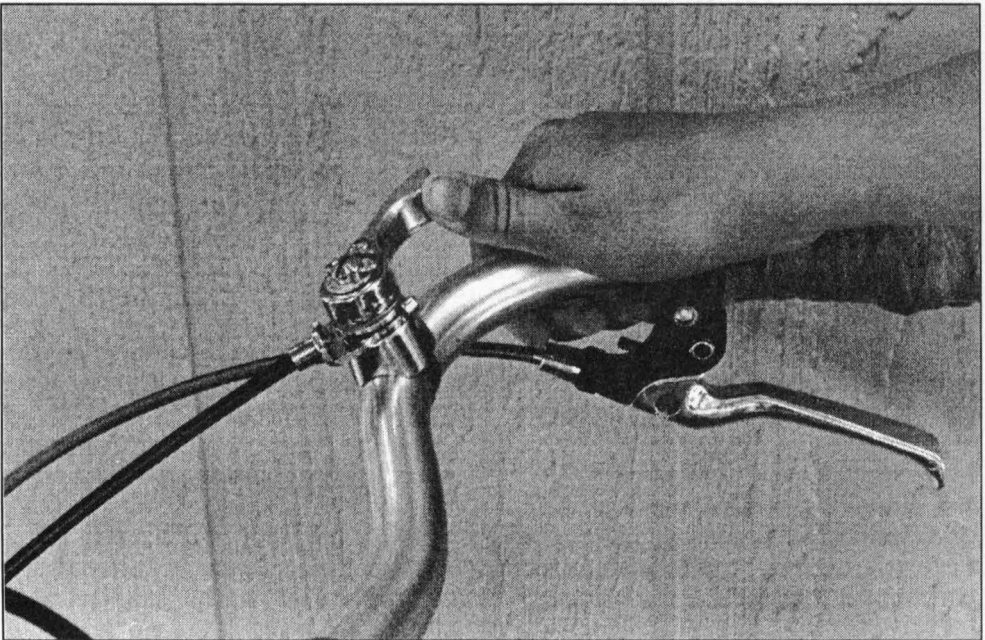

Downtube Shifters

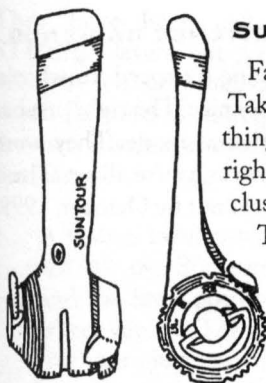

SUNTOUR SUPERBE PRO 6/POWER RATCHET SHIFTERS

Fantastic shifters, either on the downtube, mounted onto Kelley TakeOffs, or as half the component in Hybrid Bar-ends. The neat thing here is that both shifters have SunTour's power ratchet, and the right one indexes most modern (Shimano, Sachs, SunRace) 6-speed clusters, too. With the right derailleur, such as a SunTour XC Pro.

There's a grey band of rubber across the grip-portion of the lever. This improves your grip while shifting, a boon to slimy fingered cyclists worldwide.

ITEM# 17-038

MEMBER PRICE \$35
NON-MEMBER \$38

SUNTOUR SPRINT POWER RATCHET SHIFTERS

Sprint was a 1987 SunTour group that went head to head with Shimano's 600 group and got trounced. One reason was that it didn't index. So in that way, you can regard these as the levers that killed Sprint. The irony is that, in ways that matter here in the be-blinded world of Rivendell, they're better than any shifter Shimano-san has ever made. If you want non-indexed shifters, you won't find any better than these. Perfect on the downtube, on TakeOffs, or on hybrid bar-ends. They don't slip, the shift great.

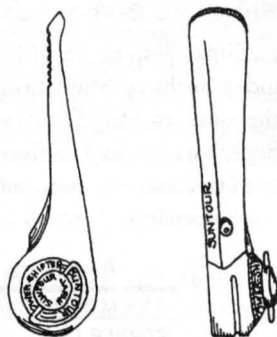

ITEM# 17-036

MEMBER PRICE \$27
NON-MEMBER \$32

SUNTOUR SUPERBE PRO 7/FRICTION SHIFTERS

The left one has a really fine power ratchet, which is as good as shifting gets. The right indexes most modern 7-speed clusters, provided you have the right derailleurs and so forth; and has two other modes, as well. One is a fake index, which "clicks" on the same spots as the real index, but the clicks are softer and overrideable. The other is a pure, smooth, friction mode. To find this, just line up the red marker-indicator on the dial halfway between index and fake-index (marked F or Fric or Friction) on the dial. The integral lever stops are curved to fit standard 28.6mm downtubes, but people have put them on oversized downtubes as fat as 31.8mm, and no problem. These can't be mounted on Kelly TakeOffs.

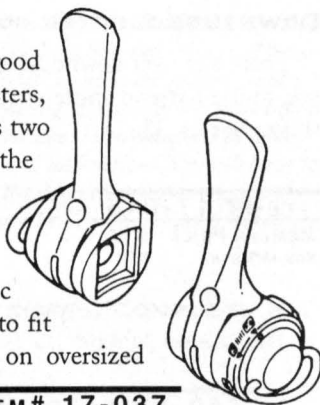

ITEM# 17-037

MEMBER PRICE \$25
NON-MEMBER \$28

Handlebar-End Shifters



SUNTOUR 1986 6SP/POWER RATCHET BAR-ENDS

These were made in 1986, for indexing six-speed freewheels. The left lever is pure power ratchet, very nice. The right one has the index mode as well as a pure friction mode. They work great, and if you can get over the blackness, you're all set. These are the last of them; we expect to be sold out by October, 1999.

ITEM# 17-031

MEMBER PRICE \$45
NON-MEMBER \$49

SHIMANO 8-SP/FRICTION BAR-ENDS

Either 8-sp or 7 sp. Good shifters, and if you want to index Sachs or Shimano or SunRace clusters, these are the ones to get. Or if you want to make your own SuperMix bar-end shifters, these are the ones to get, but then you toss the lever part. If you do that, please order the 8-speeders.

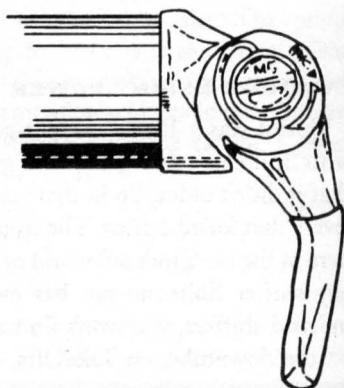

8-SPEED

ITEM# 17-062
MEMBER PRICE \$68
NON-MEMBER \$71

7-SPEED

ITEM# 17-019
MEMBER PRICE \$68
NON-MEMBER \$71

DOWNTUBE SHIFTER BOSS ADAPTERS

These slip over downtube shifter bosses, allowing you to use bar-end shifters on bikes with downtube shifter bosses. 33g.

ITEM# 17-045
MEMBER PRICE \$17
NON-MEMBER \$18

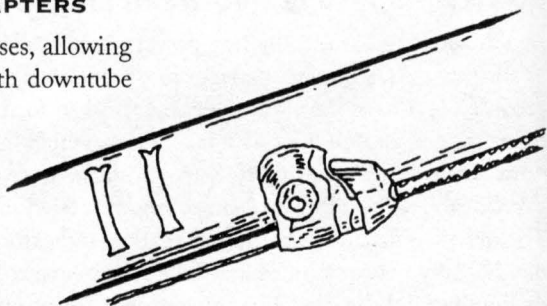

Kelly TakeOffs

They have been called "Poor Man's STI/Ergo" levers, but that focuses on their relatively cheap price, and what's good about TakeOffs is how they work, and all the their advantages over STI and ERGO.

Such as:

1. A VISUAL INDICATION OF WHAT GEAR YOU'RE IN. Sometimes that's handy, and the lever position tells you about where you are. The dials Shimano now has are just another interference between you and the bike. It's never necessary to know what gear you're in, and you can always look back there if you gotta know, so a shift lever position suggestions is more than ample as an indicator.
2. YOU CAN SHIFT FROM MORE HAND POSITIONS. Try shifting STI or Ergo from the top of the bars. You can shift TakeOff-mounted levers from all over the bike. If you want convenience, take it all the way.
3. YOU GET THE CONVENIENT POSITION AND YOUR CHOICE OF SHIFTERS. Many of our customers want the position, but don't want to give up their beloved friction shifting. This way, you get it all. Or, you can always buy downtube shifters that index 6-7-8-9 speeds, if

that's what you want. And they all have friction back-up modes, as well.

4. THEY LET YOU USE PARTS YOU MAY ALREADY HAVE. A spare pair of road brake levers, from when you stripped them off to go modern? Old downtube shifters from the Pleisostene Age? Get a set of TakeOffs and bring them to life again in a different configuration.

There are some situations where STI or Ergo shifting is faster, and if you're a competitive road racer or just like to pretend, be forewarned that off-the-saddle shifting with Ergo still beats this. And, if you're down in the drops and chasing hard and just want to drop the chain to the next highest gear, either STI or Ergo will do that about 10 percent easier. But it's already easy enough, and for any non-competitive situation, the slight speed increase of STI or Ergo doesn't mean beans.

If you have a few bikes, set them up differently. Try TakeOffs on one of them. You'll never rue the day, and there's a good chance they'll be your favorite.

For more information, see Chris Kelly's website: www.kellybike.com.

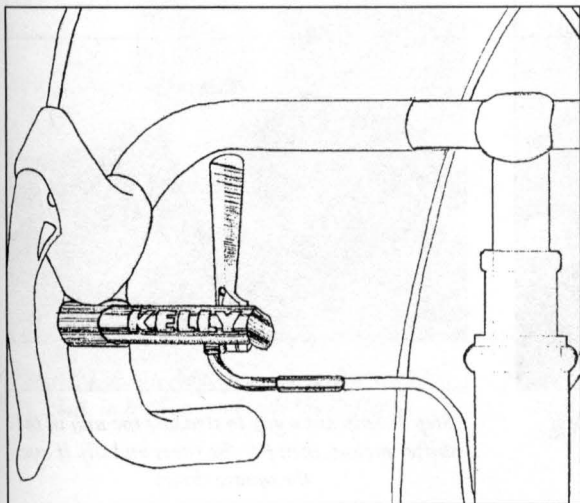

TakeOffs accept downtube shifters, and even Shimano bar-end shifters. A "complete kit" includes the mounts, cables and housing, a couple funny little tubes, downtube shifter adapters as cable stops, and instructions. You still have to buy the downtube shifters. If you get them here, get SunTour Sprints.

TAKEOFFS, COMPLETE KIT
(cables, mounts, no shifters)

| |
|---------------------|
| ITEM# 17-051 |
| MEMBER PRICE \$75 |
| NON-MEMBER \$80 |

SuperMix Bar-Ends



he best bar-end shifters we've used are made by grafting SunTour Sprint downtube shifters onto Shimano bar-end shifter mounts. The mounts aren't available separately, so you have to spend \$68 to buy the complete Shimano bar-end shifter set, and THEN buy the additional downtube shifters. (Unless you already have some.) But if you buy the Shimano shifters and the SunTour Sprints on the same invoice, we'll sell you the latter for \$13, less than half price.

But forget about price. This set up is positively dreamy. If you like bar-ends and you want friction, you will fall head over heels in love instantly. Truly, the Taj Mahal of bar-end shifters.

Last November (1998) we started working with Dia-Compe on a mount that takes the place of the Shimano mount, so we wouldn't (and you wouldn't) have to buy the whole Shimano rig, just to toss the shifters that come with them and put on others. (The shifters that come on them are fine, but if you don't need the indexing, spend another \$13 and get the Sprints.) Anyway, we dearly hoped to have them months ago, but things take time, and here it is catalogue time and we still don't have them. Dia-Compe says "prototypes by mid-June." We'll see how that shakes out, and as always, we will keep you posted in the Reader. Meanwhile, buy the Shimanos and put on the Sprints yourself. Here's how.

What you need:

- Shimano bar-end shifter mounts
- Sprint DT shifters
- Dykes
- A file

The first step is to tighten the mounts into the handlebar end, but we aren't showing that here. Pretend they're in there already.

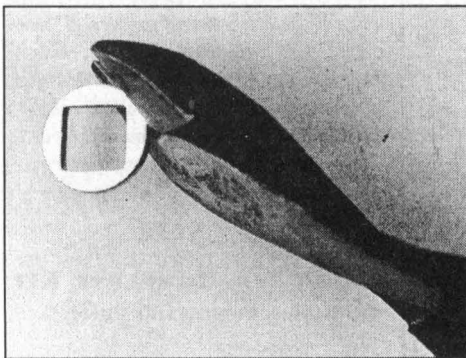
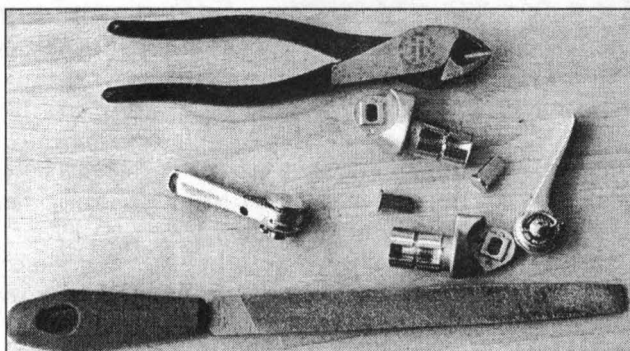

Step 1: Snip off the shifter boss stop. File it smooth.

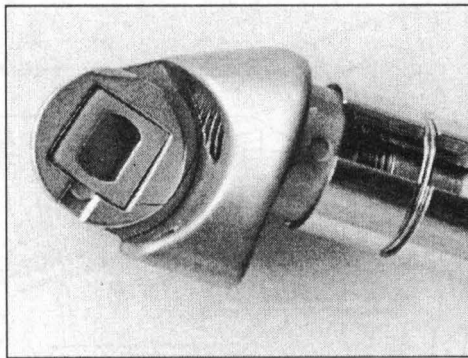

Step 2: Snip out a gap to straddle the nub in the shifter mount, then file the edges and slip it over the square thing.

SHIFTERS

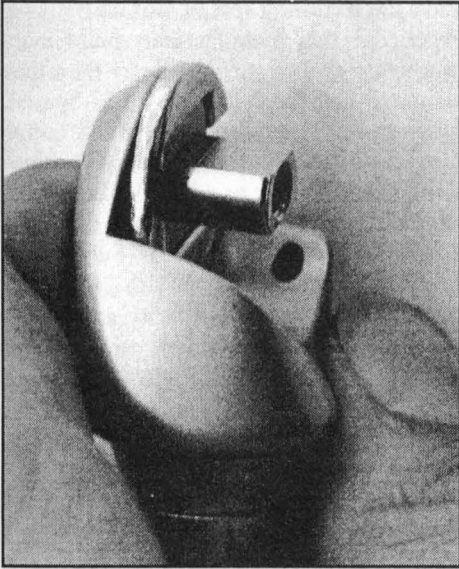

Step 3: Put the internally threaded loose boss into the mount.

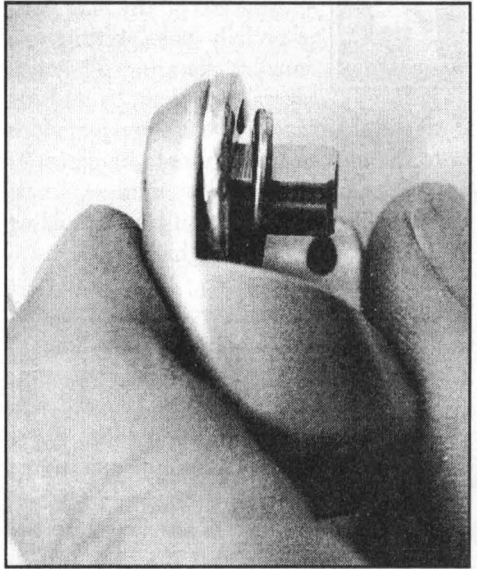

Step 4: Put the silver SunTour washer onto it. Push it up flush.

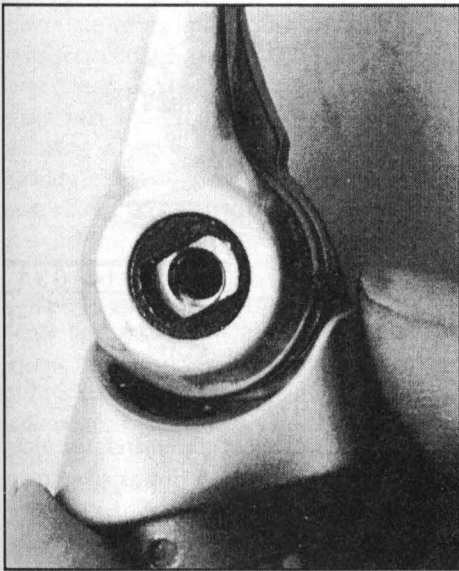

Step 5: Line up the flats in the shifter with the flats in the boss, and slide the shifter on.

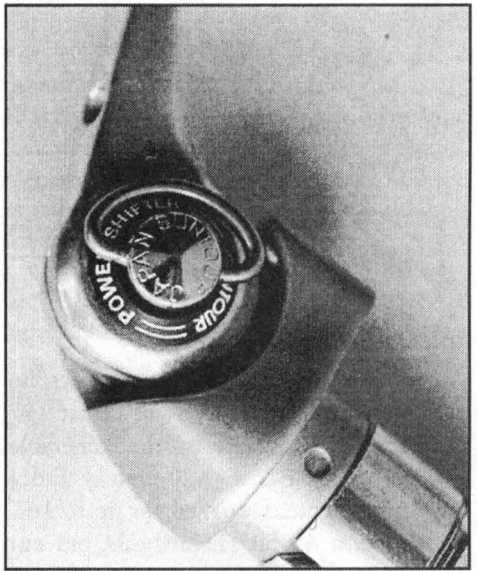

Step 6: Put the plastic SunTour badge back on (if it fell off), and then hold it all together with the wing bolt. These are the smoothest, slickest, best bar-end shifters you can get.

Front Derailleurs



Front derailleurs have the easiest job of any bike part, especially when shifting to a smaller chainring. They just de-rail the chain by pushing it off the chainring, and the chain just plops onto the next one. Upshifts to bigger rings are harder, but the only way to mess one up is to pedal too slowly; and if you're pedaling that slowly, why shift to a harder gear?

There are front derailleurs for every gearing and frame configuration. Here's how to pick one that'll work for you for sure.

1. Make sure it fits your seat tube. Every derailleur we sell fits 28.6mm seat tubes, the standard size for steel frames. Aluminum seat tubes are fatter, and require a bigger clamp.

2. Capacity. Front derailleurs have different capacities, which means some are designed for two chainrings no more than 14t or 16t

apart, and others are designed for triples, and a 24t chainring spread. But it's been our experience that manufacturers build more range into their front derailleurs than they claim to. Our much ballyhooed \$7 Special, for instance, is rated to 16t, which means SunTour intended it to be used with something like a 50 x 34, or a 52 x 36. In the real world, it works great with up to a 50 x 46 x 24 with a 13 x 32 in the rear. Subtract 24 from 50 and you come up with 26t—a full 10 teeth above its rated capacity, and 2 teeth beyond the recommended capacities of most touring or mountain bike front derailleurs! Can we interest you in a \$7 Special now?

In this catalogue we have just two front derailleurs. We stock more models, but these are the only ones we have in sufficient quantity to list here; and besides, they work with all normal bikes. If you need a SunTour Cyclone or NOS Dura-Ace, we may have that, too. Ask.

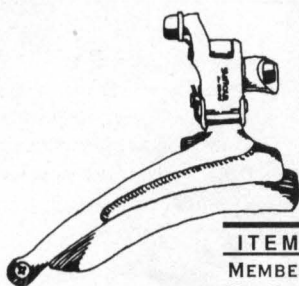

ITEM# 17-027
MEMBER PRICE \$27
NON-MEMBER \$33

SUNTOUR ALPHA 5000

Our most popular model, since, despite our protests, most don't trust \$7 derailleurs. Compared to the venerable SunTour Lite, it is slightly prettier and a few grams lighter. Designed for up to 16T difference in double chainwheels, but our experience shows that it works great on triples with up to a 22t tooth difference. Almost every built-up Rivendell or Heron gets built with this.

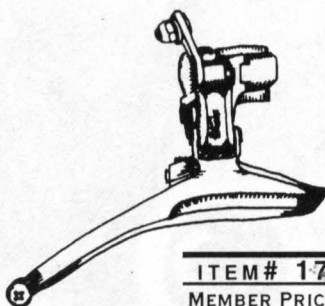

ITEM# 17-034
MEMBER PRICE \$7
NON-MEMBER \$9

SUNTOUR LITE

Works great, looks fine, and the only weird thing is that the clamp is sized for a 31.8mm seat tube, so you need the supplied shim and a single wrap of bar tape to make it fit a normal seat tube. I/Grant ride this every day. Good for road doubles with up to a 16t difference in chainwheels; and half-step + granny triples.

How To Pick A Rear Derailleur

THE BIG DEALS ARE CAPACITY AND CHAIN WRAP.

Capacity is how big a rear cog it'll shift to. This is determined by how low the upper pulley is when it's all the way inward, close to the spokes. If the pulley runs into the cog, it won't shift onto it. They (the rear derailleur makers) can design a derailleur with a low pulley, but then it won't shift as well on the lower range of gears (the small cogs).

Some racing derailleurs from the past had a 24t capacity. You could always get another 2t out of them, though. Most racing derailleurs these days go to 26t or 28t, and you can usually get another 2t out of them, too. We don't advocate doing that, but if you have a rear derailleur that's rated to 26t on your bike, and you have a special ride coming up and want just a little lower gear, try it out before buying a new derailleur. We've managed to get to 32t with a derailleur rated to 27t, just by shortening the chain, which pulls the pulley down. There are other ramifications to this—for instance, you'll lose access to some of the larger rear cogs when you're on the big chainring; and probably it'll screw up your indexing if you've got it, but the point is, nobody ever died from braking these particular rules, and sometimes knowing what you can and can't do can save you dough.

Chain wrap is the derailleur's ability to bend the chain and take up slack. The longer the rear cage is (the thing that the pulleys are in), the more chain the derailleur will wrap. If you ride with a 26t spread up front, like 50t big ring and 24t small ring (50 minus 24 is 26), and a big one in back (13 x 32, or 19t, because 32 minus 13 is 19),

then you need a rear derailleur that can wrap 26 + 19, or 45 teeth. Nobody makes one, which is why no manufacture specs a bike with those chainring combinations. But here again, that doesn't mean you can't use them. When you have a triple, it's pretty well understood, or at least hoped, that you use the small front chainring (the 24t-er) with only the 3 largest cogs. It's a bail-out gear, a gear to use when you need something really low, and by definition that rules out using it with the smaller rear cogs. So that changes things. You still have the 26t spread up front, but if you limit your 24t chainwheel to the 3 largest rear cogs, you don't need to subtract the 13 from the 32; you just have to subtract the smallest cog you'll use with it from it. That may be a 22t cog (on a 13-14-15-18-22-26-32 seven speed freewheel). So 32 minus 22 is 10; add the 26 from up front, and you get 36t. Lots of derailleurs can wrap that many teeth!

Don't be confused by the numbers. They're easy to understand once you get the hang of it, and you don't have to be a math-type. For instance, I got a D- in Algebra 2. It's not that I was dumb; it's because all I thought about was trout (and girls, but I actually caught trout). In any case, the following pages have all our rear derailleurs, and we tell you what they're good for. If we explain it poorly here, just call and ask and we'll try another way.

Our actual stock is larger than what we list here, but these are the ones we have in catalogue-able quantities. If you recall a model from a past catalogue, we might have a few.

—Grant

SHIMANO RX100 REAR DER

Basic, great shifting Shimano model for two-chain-wheel road bikes and sub-29t rear cogs. All silver, simple, solid, and it shifts as good as any. RX100 continues to be a diamond-in-the-rough in the Shimano line.

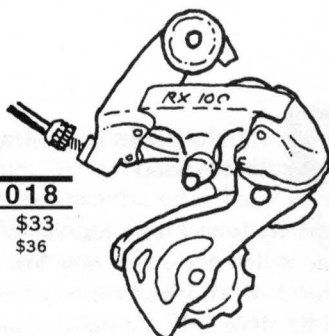

| |
|---------------------|
| ITEM# 17-018 |
| MEMBER PRICE \$33 |
| NON-MEMBER \$36 |

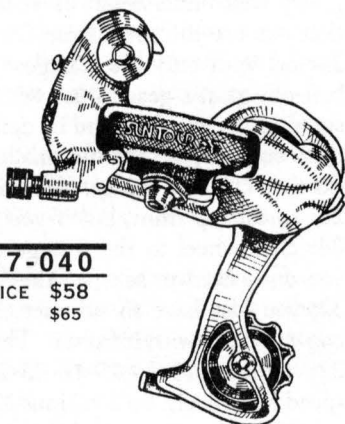

SUNTOUR XCPRO SHORTIE

This was SunTour's best mountain triple derailleur, in a short cage version. If you can live with a rear cog no larger than 28t, you don't do better than this one. Finely finished, strong, and good for at least 40 thousand shifts. Perfect for road doubles and non-wide range triples—something like 46 x middle x 24, with up to 28t in the rear.

| |
|---------------------|
| ITEM# 17-040 |
| MEMBER PRICE \$58 |
| NON-MEMBER \$65 |

SHIMANO DEORE XT/GT

As good a rear derailleur as there ever needs to be. Indexable, frictionable, and Shimano makes it, so you know it works. This one has gone through several changes throughout the years, all small, none of them made it any worse, and even the first ones, about 10 years ago, were just fine. Largest rear cog: 32T. Performance and Nashbar can always beat our price, sometimes by as much as \$20. They must buy them cheaper than we do, but we feel obliged to offer this anyway, so here it is.

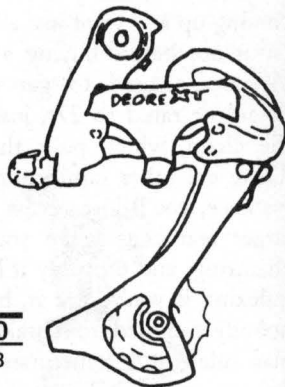

| |
|---------------------|
| ITEM# 17-010 |
| MEMBER PRICE \$48 |
| NON-MEMBER \$50 |

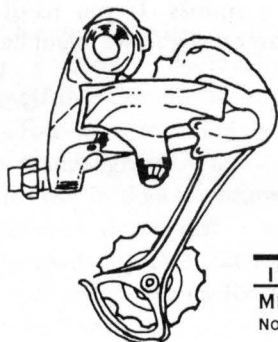

SHIMANO 105 RACING TRIPLE

For triples up front and up to 28t in the rear. This year's version is shiny silver, looks great, and given all that, it's hard to justify anything fancier and costlier. For triples with more than 28t in the rear, see our Touring triples.

| |
|---------------------|
| ITEM# 17-059 |
| MEMBER PRICE \$40 |
| NON-MEMBER \$49 |

Chainrings & Gearing



ff-the-shelf, two-chainring style road bikes come with 53t big rings and 12t small cogs, and the resulting 119-inch gear isn't all that useful.

If you just want to ride solo or with friends who aren't bent on dropping you, you'll probably want a big ring between 46t and 51t, and a high gear between 96 and 104.

The smaller ring lowers your top gear, so you'll "run out of gear" earlier. But it also lowers all subsequent gears, so you'll probably ride them more. Smaller big chainrings are a revelation!

FIVE WAYS TO GEAR A BIKE

1. CROSSOVER (DOUBLE)

Road racing gearing. With chainwheels ten to fourteen teeth apart (53 x 42 is typical these days), and the rear cogs close together. It's popular with racers because shifting is easy. The drawback: You don't get a very low gear. If you ride flat roads or are strong enough to race, that's okay.

2. ALPINE (DOUBLE)

Big differences in the chainrings, like Crossovers, combined with medium range rear cogs, usually up to 26 or 28 teeth. A popular gearing on production bikes in the '70s, but not seen that much anymore. The gearing range is too low for racers, and the shifting sequence is too awkward for gear freaks, but if you want to avoid triples and you don't need super low gears, it actually works okay.

2. HALF-STEP + GRANNY (TRIPLE)

Closely spaced middle and outer chainrings plus an independent small (granny) chainring, and a wide range in the rear. A typical

HSG has chainrings of 50/46/28 combined with a 13 x 32 rear, but there are dozens of other ways. HSG is a good way to get a wide range of gears, small increments between them, and a simple shifting sequence. If you're interested read RR11 & 12, or send for reprints of the half-step stories in those issues.

3. MOUNTAIN TRIPLE

Big jumps between the chainrings, and a wide range in the rear: 46/ 36/ 24 x 12/ 28, for instance. It's like Alpine gearing, with an extra chainring, and is good for off-road riding, where the terrain slows you down quickly, and small decreases in gearing aren't all that useful. Modern "compact" triples are a variation, but with smaller rings and rear cogs: 42/32/22 x 11/26.

4. RACING TRIPLE

Big, ten-tooth jumps in the front rings and small jumps in the rear, which is typically an 8- or 9-speed. 50/40/30 x 12/26 is typical. You select the front chainring for the approximate highs and lows the next few miles will require, and then shift in the rear. The 8- and 9-speed rear cogs require more rear wheel dish, so you get weaker wheels. If you don't need the range, you can do a racing triple with a 6 or 7 rear cogs.

There are lots of ways to gear a bike, and they all work! Cyclists couldn't even coast until the '30s, and when multiple gears came about it was a royal pain to change gears. It's not quite sane to keep rejoicing about advancements that were made fifty or more years ago, but it's a good perspective to keep handy.

—Grant

Chains



e like cheap strong silvery chains, and if they have master links, yahoo. Cheap, because chains are no fun to buy. Strong, obviously.

Silver, because silver looks good and the light color makes it easy to tell when it's yucky.

The new 9-speed chains are not so smart.

They're too skinny, the pins are too short, they can't easily be serviced by non-surgeons. To be avoided when possible.

It has been pointed out to us that Nashbar sells chains cheaper than we do. Well, we do what we can, but I imagine Arnie Nashbar has a little bit more buying clout than I do.

—Grant

SUNRACE SILVER

A good-pretty-inexpensive chain that works with anything between friction and 8-speed indexing. Shiny silver, looks great on any bike, and won't break. Has master link.

| |
|---------------------|
| ITEM# 13-031 |
| MEMBER PRICE \$10 |
| NON-MEMBER \$11 |

SACHS P51

A German chain, strong, silver and black, and it comes with a built-in "power link," which lets you take it apart and assemble it by hand. Good for anything short of 9-speeds.

| |
|---------------------|
| ITEM# 13-019 |
| MEMBER PRICE \$19 |
| NON-MEMBER \$20 |

International Freewheels

SRAM bought Sachs a couple years ago, and in those two years, has stopped making both 6-speed and 7-speed freewheels. That's not joyous news. We're getting freewheels wherever we can: SunRace from Taiwan, Sachs from Germany, and Shimanos from Singapore. The time has come to quit being a freewheel snob, and just pick one that has a good enough range of gears, and just pedal, shift, and go. Call for the latest selection, which will probably include some of the following:

6 SPEEDS

REGINA

12-14-16-19-22-26

| |
|---------------------|
| ITEM# 13-028 |
| MEMBER PRICE \$45 |
| NON-MEMBER \$49 |

SHIMANO

14-17-20-24-28-32

| |
|---------------------|
| ITEM# 13-036 |
| MEMBER PRICE \$16 |
| NON-MEMBER \$17 |

7-SPEEDS

SACHS

12-13-15-18-22-24-28

| |
|---------------------|
| ITEM# 13-015 |
| MEMBER PRICE \$48 |
| NON-MEMBER \$50 |

SUNRACE

13-14-16-18-21-24-28

| |
|---------------------|
| ITEM# 13-029 |
| MEMBER PRICE \$20 |
| NON-MEMBER \$23 |

CRANKS

TA ZEPHYR CRANK

TA is short for "traction avant," which means "traction front," and refers to a long-since forgotten front-wheel drive automobile mechanism of some sort. Zephyr means a *soft, gentle wind*. TA cranks have long been regarded as top-quality and somewhat quirky. Mostly, that's the fault of the very fine but quirky Cyclotouriste model, which is still made and favored among French traditionalists, but nobody else. The soft, gentle wind is totally quirk-free. It has a straight forward design that uses a minimum of hardware, is compatible with all front derailleurs and many bottom brackets, and compatible chainrings are common throughout the free world.

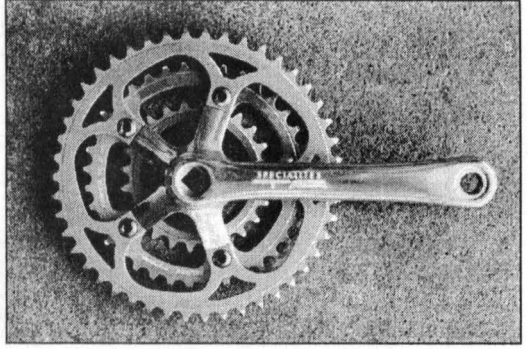

Since the Ritchey Logic was discontinued last year, this is our favorite triple crank. It has a 110/74/58 bolt circle diameter, which means it accept outer chainrings up to infinity, middle chainrings as small as 34t, and inner chainrings as small as 24t on the 74mm circle, or as small as 20t on the 58mm one. That means you can tour with a 26t rear cog!

What we like about this crank: It's forged. It has a low Q-factor (around 153mm with a Phil 123mm spindle). It's silver, it's well finished. It's made by one of the oldest crank makers, and one with the rare distinction of never having made a low-brow crank. It's French. It does carry over one TA tradition that everybody should copy, but nobody does—recesses for pedal washers, which protect the finely polished crank arms from getting gouged by the pedal shoulders when you tighten the pedals on.

For road triples, a 119 to 123 bottom bracket spindle generally works well. For mountain triples, a 122.5 to 123. For road doubles, a 112 to 114. **SOLD WITHOUT CHAINRINGS**, but with all the bolts, nuts and spacers, and instructions.

TA 175

| ITEM# | 12-124 |
|--------------|--------|
| MEMBER PRICE | \$200 |
| NON-MEMBER | \$210 |

TA 172.5

| ITEM# | 12-123 |
|--------------|--------|
| MEMBER PRICE | \$200 |
| NON-MEMBER | \$210 |

TA 170

| ITEM# | 12-122 |
|--------------|--------|
| MEMBER PRICE | \$200 |
| NON-MEMBER | \$210 |

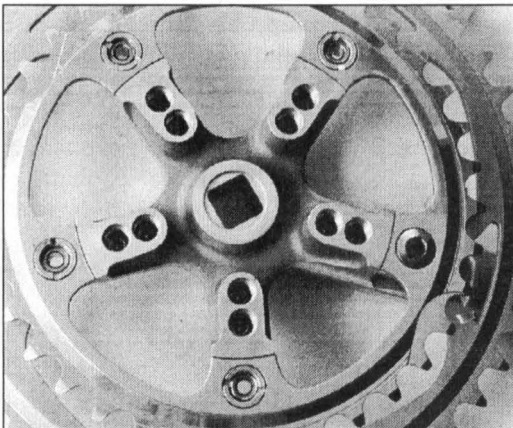

This is the backside of the Soft, Gentle Wind, showing the extra set of holes good for 58mm bolt circle chainrings. Smart!

Bottom Brackets



he Flintstones didn't use bottom brackets, just bottom bracket spindles, and if we want to get technical and still talk about the

Flintstones, we can say that the spindles were axles, not spindles. Spindles turn, axles don't. A bottom bracket consists of a spindle, bearings, and whatever it takes to hold it all together, usually cups (in the case of cup-and-cone models) or retaining rings (in the case of sealed models).

THE LENGTH OF THE SPINDLE is determined by the crank you use and the frame it's going on. Most crank makers specify a length, but a particular frame may call for something else. Ask us; we may know.

Another consideration is the taper dimension. There is a JIS standard, popular in Japan and on most mountain bike bottom brackets; and an ISO standard, common on road cranks, especially European ones. They both have similar tapers, about 2-degrees, but the ISO spindle is skinnier, so if you put it into a JIS crank, the crank may slide on too far.

CUP-AND-CONE BOTTOM BRACKETS are a dying breed, but not because they aren't good. Manufacturers, who use up the bulk of the bottom brackets made, don't like them because they require skilled labor and more time to install and adjust. Bike shops generally dislike them for the same reason. Your local shop may be an exception, but probably isn't. Still, if you take both a cup- and-cone bottom bracket and a cartridge bottom bracket of the same price and quality and subject them to the same loads, the cup-and-coner will probably last five times as long. The weak point in a

cartridge model is the bearing retainers. They're fine for even-loading situations in industry, but have a hard time with the hard, uneven, twisting loads imposed by a strong stout guy torquing them up the steep driveway. Ca-rack! Ca-runch!

Phil Wood makes a fantastic bottom bracket. Actually, it is perfect. It costs a lot, and is worth every cent. They've been doing them for 28 years, and I've been in the thick of bikes for that long, and have heard of only three problems, ever, and those were a long time ago. They're machined from 17-4 stainless (you can tell, because it's magnetic), and use only the best quality bearings. They come in too many widths to fit too many cranks, and if you're a weight nut, there's a titanium model also. You can get Famous Name sealed bottom brackets for about half what a Phil costs, but none has Phil's quality or reputation.

The Ritchey cup-and-cone models are no longer made, but we have plenty, and they mate perfectly with Ritchey cranks, which are now available only in Compact drive, which we don't cotton to or carry. They're unique among cup-and-coners in that their bearings are farther apart than usual. It's a smart design, but makes adjusting them slightly more challenging. Use a green Park pin spanner and you'll do fine.

The Generic models combine perfectly compatible parts from different makers, resulting in high grade bottom brackets for very little dough.

If you have a question regarding bottom bracket/crank compatibility, call us up.

—Grant

◊ BOTTOM BRACKETS ◊

PHIL WOOD BOTTOM BRACKET

Totally reliable, no maintenance for fifteen to thirty thousand miles. Specify spindle length: 103, 108, 111, 113, 116, 116 for Superbe, 119, 123 and threading: English, Italian, French, and Swiss. Ti models available, \$265. They're a couple ounces lighter. Mounting instructions included.

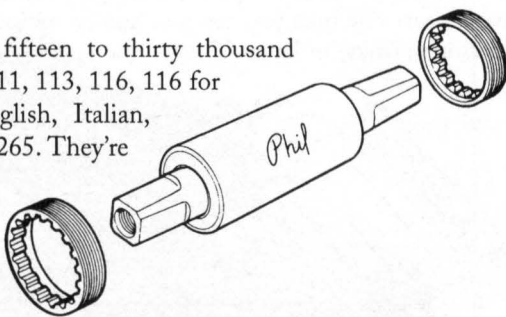

ITEM# SEE CHART

MEMBER PRICE \$123
NON-MEMBER \$128

| Spindle length | Item # |
|----------------|--------|
| 108 | 12-045 |
| 111 | 12-046 |
| 113 | 12-047 |
| 116 | 12-048 |
| 116.5 Superbe | 12-049 |
| 119 | 12-050 |
| 123 | 12-051 |

Retaining Rings: \$17 per set
 English # 12-053
 Italian # 12-054
 French #12-052

PHIL WOOD BB TOOL

For installing and removing Phil bottom brackets. You can do it with one, but it's easier with two. Use with vise grips or a crescent. Sold each.

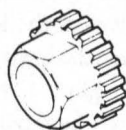

ITEM# 19-035

MEMBER PRICE \$9
NON-MEMBER \$12

RITCHEY LOGIC

Two grades. The Pro, with ground and polished bearing surface; and the Comp, not as hard or smooth, but still good for 15,000 miles.

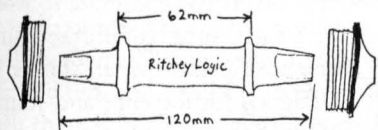

COMP

ITEM# 12-055
MEMBER PRICE \$22
NON-MEMBER \$49

PRO

ITEM# 12-117
MEMBER PRICE \$40
NON-MEMBER \$49

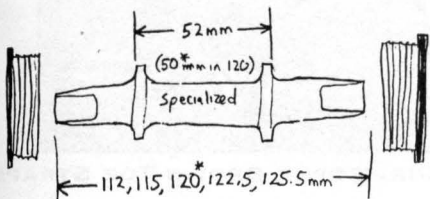

GENERIC & GOOD BOTTOM BRACKET

Specialized Pro spindles and excellent, but not pro grade Tange Cups, with 11-ball retainers. Fits most Japanese cranks. Fantastic deal. Specify the spindle. English cups.

115MM

ITEM# 12-006
MEMBER PRICE \$15
NON-MEMBER \$17

122.5MM

ITEM# 12-009
MEMBER PRICE \$15
NON-MEMBER \$17

CUPS & BEARINGS

ITEM# 12-001
MEMBER PRICE \$12
NON-MEMBER \$15

⊕ PEDALS, CLIPS, AND STRAPS ⊕

The performance difference between clippable and clipless pedals has been grossly exaggerated. Even if you prefer clipless pedals for your race bike or weekend marauder, it's good to have at least one bike you can just hop on and ride. All the pedals we offer are made by Mikashima (mks) in Japan. They're good pedals and good values.

—Grant

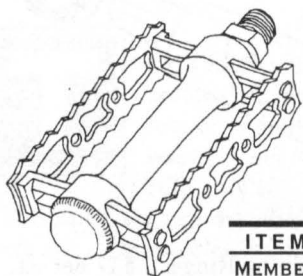

MKS TOURING/CYCLO CROSS PEDALS

Our most popular pedal, and the one that draws the most raves. It looks like a cheap rat-trap pedals from the '70s, but it's excellent quality, lasts for years of hard use, and is our first choice for off-road, city, and general rough-stuff riding. Big foot support. Excellent pedal for toe-clipless riding, too, since both sides are the same. Easy to flip into if you use clips.

ITEM# 14-020
MEMBER PRICE \$38
NON-MEMBER \$43

MKS SYLVAN TRACK PEDALS

Classic track-style aluminum cages with screw-on dustcaps, and serviceable bearings. Not pro quality, but they break in nicely, get smoother as they go, and ought to last 15,000 miles. Sometimes the factory adjustment is a little tight (as factory adjustments tend to be). If so, remove the dustcap, hold the wrench flats in a bench vise, and loosen the locknut. Then loosen the cone 1/12 turn, and cinch down the locknut.

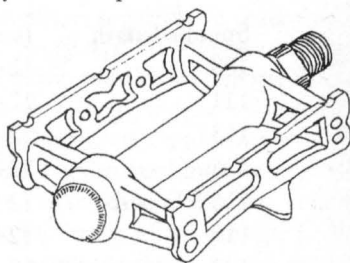

ITEM# 14-021
MEMBER PRICE \$45
NON-MEMBER \$49



MKS PLATFORM

Our cheapest pedal in price and quality, but it's not garbage by any means, and it's the best pedal we know of for pedaling with sneakers, Hush Puppies, dress shoes, or thongs (shoe-type). I've often worn Converse All-Stars and pedaled up the local 11-mile mountain with no measurable loss in time or comfort. If you commute to work in regular shoes, or just want a nice, comfortable and easy-to-flip-into pedal, this is it. Designed for toe clips and straps, of course.

ITEM# 14-030
MEMBER PRICE \$45
NON-MEMBER \$49

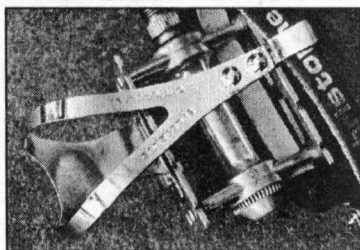

CHRISTOPHE TOE CLIPS

Chromed steel toe clips that were the standard for decades. Shown with pedals and straps, not included!

| | |
|------|--------|
| Size | Item # |
| S | 14-015 |
| M | 14-014 |
| L | 14-013 |
| XL | 14-014 |



CHRISTOPHE BROWN TOE STRAPS

Not laminated, but you probably aren't going to race in them, so it doesn't matter. They comes with ALE buckle pads, as long as our supply lasts. A good deal! Note the routing.

ITEM# 14-031
MEMBER PRICE \$9
NON-MEMBER \$49

SHOES!

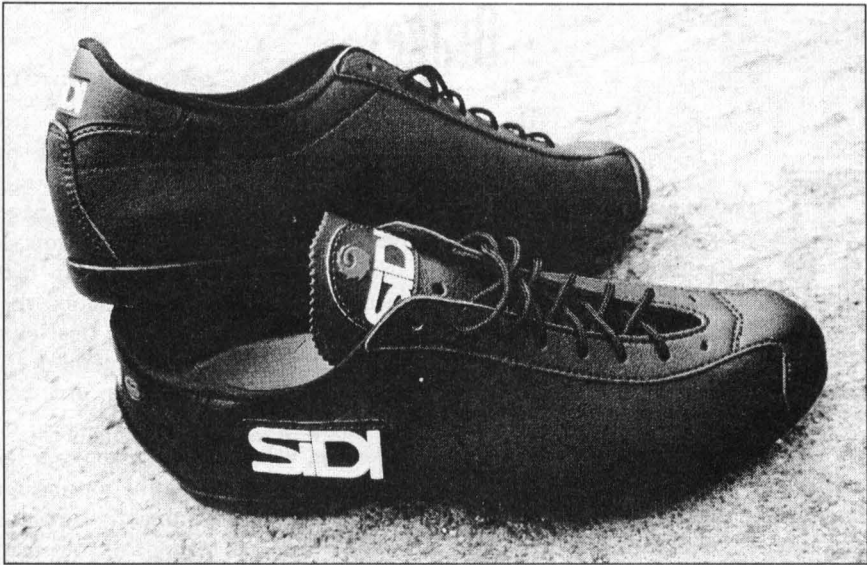

SIDI TOURING SHOES

The cycling shoe situation is bleak for us knuckledraggers who still don't ride clipless. Two years ago Adidas came out with a clippable shoe; then had some financial problems presumably unrelated, and was promptly sold to somebody else, who trimmed the line, and you know what got chopped first. Last year, NorthWave followed with its "classic" shoe, but that just meant it laced up and was black. They never made a cleat for it. You can get sport-util-ity shoes with lugged soles and SPD capabilities, but they don't slide easily into toe clips. You can get BMX shoes, with dark green suede leather uppers and a shiny white rand, but I'd rather ride in Cons. You can send to England for some nice all-leather jobs, pay in £ and hope they fit, then have a cobbler put on half-soles. Or you can get these Sidis. Sidi has made them for a decade at least, but hasn't exported them, because the U.S. market is generally not interested. But after minimal pleading, they agreed to bring them in just for us, believe it or not. (Not available in stores!) They're great shoes. Lorica (fake leather) uppers, person-made-sole with ridges that grip vertical pedal cages (they work great on regular road pedals); and traditional laces, so your velcro habits won't work.. They fit most feet. You can walk in them. They're water and mud resistant. Sizing: Everybody here ordered samples in our "old Sidi size," and they were too small. The chart below is based on our own experience with these shoes. If you get the wrong size, return them unriden for a replacement. If pair no. 2 doesn't fit, return them for credit. If we have more than 50 returns, we're bowing out of shoe biz. Note: A men's 8 is a women's 9.5, etc. A size and a half difference

—Grant

| Men's Size | Sidi Size | Item # |
|------------|-----------|--------|
| 7 | 39 | 22-052 |
| 7.5 | 40 | 22-053 |
| 8 | 41 | 22-054 |
| 8.5 | 42 | 22-055 |
| 9 | 43 | 22-056 |
| 9.5 | 44 | 22-057 |
| 10 | 45 | 22-058 |
| 10.5 | 46 | 22-059 |
| 11 | 47 | 22-060 |

| ITEM# | SEE SIZES |
|--------------|-----------|
| MEMBER PRICE | \$125 |
| NON-MEMBER | \$125 |

Brakes



We're one of the last places you can buy single-pivot sidepulls. In the mainstream market they're dead, and I don't know any manufacturer who still makes them. Dual-pivots have taken over.

Dual pivot brakes work great. They're the bike equivalent of power brakes, but the advantages come at a price, and the price, in this case, is fender clearance.

"Fender clearance?!" you say, "I don't need no stinking fender clearance!"

If you don't ride your nice bike in the rain, that's true, you don't. But our deal here is that we think every bike should have the potential to be an year-round, all-weather bike, and we're doing our part to make that a reality for you, by selling single pivot sidepulls.

Don't get the idea that they're less brake than a dual pivot. True, you do have to squeeze harder for the same amount of stopping power. But cyclists did this for years, and nobody complained. Certainly, modern brake shoes have supercharged the performance of thousands of brakes, and if your braking demands are high, Mathauser-equipped Cyclones and

Shimano 600s are ideal. If your hands are weak, THEN go for the dual pivots. If you already have dual-pivots, don't take my mentioning that as an accusation that you have weak hands. We offer dual pivots as well. Can we talk about something else?

Likewise, V-brakes have taken over the off-road market, and soon the touring market, as well. It's awkward to get defensive about why we don't sell this or that, but that's our lot right now, so bear with me.

V-brakes were developed because dual-suspension mountain bikes presented problems with placing the rear brake cable housing stop. So Shimano came up with a powerful brake that didn't require one, and that is the V-brake. It had nothing to do with any real or perceived inadequacy in cantilever brake performance. There is no question that V-brakes are powerful, and for certain applications are even advantageous. But we, and thousands of others less conservative, quarrel with the notion that cantilevers are inferior. The time will come when you can't get cantilevers, and at that time we'll offer V-brakes just like everybody else, but we aren't there yet, and we won't call it *progress* when it happens. Can we talk about something else?

—Grant

Cables & Housing

Top, professional quality.

SunTour brake cables & housing—\$6 Item #15-025

For front and rear brake cables, taupe housing, stout cables, and four housing caps.

Brake cables, no housing—\$3 each Item #15-001

Stiff, strong, smooth. QBP brand. Coated, which is why they cost so much.

Derailleur cables—\$3 each Item #17-003

Smooth and coated. Same QBP brand as above. Index compatible.

BRAKES

SUNTOUR CYCLONE

These are the brakes Peter and I and Pal Jeff use to slow down. They work great and lack nothing. There's a true micro-adjusting quick release and a rubber barrel adjuster—two features that make life wonderful, and two features lacking in modern sidepulls. They center by means of two 5mm hex keys; simple. New old stock from the mid-'80s.

Maximum reach: 50mm.

Specify allen or nutted centerbolts, or we'll assume you want allen.

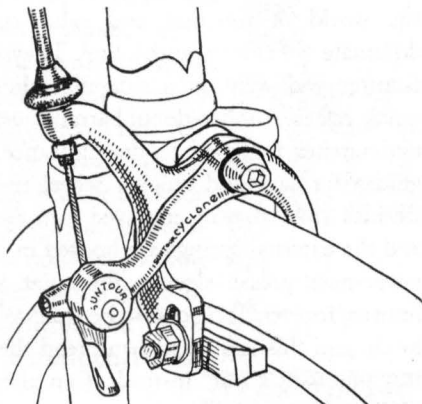

CALIPERS ONLY

ALLEN

NUTTED

ITEM# 15-026

ITEM# 15-027

MEMBER PRICE \$45
NON-MEMBER \$49

MEMBER PRICE \$45
NON-MEMBER \$49

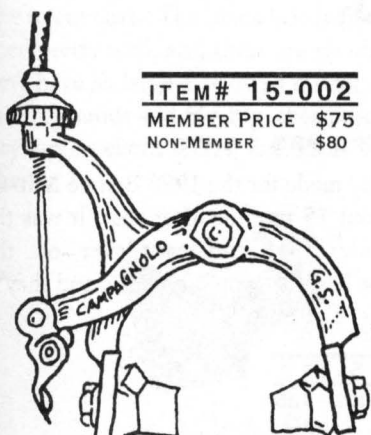

ITEM# 15-002

MEMBER PRICE \$75
NON-MEMBER \$80

COMPLETE
BRAKE SET

CAMPAGNOLO GRAN SPORT

Back in the Stone Age these were Campy's cheapies, which was like getting first runner-up in the Miss World contest (or Mr. Universe, whatever). Cold-forged, clean design that hides nothing, and everything is practical and well thought-out. At \$75 per complete brakeset, these have got to be the best deal around, and the only thing we'd change is the cable housing, which—although good enough for Eddy Merckx, isn't as good as the new delrin-lined stuff, which we sell for \$5, including cables.

SHIMANO RX100 DUAL PIVOTS

The best value in a dual-pivot sidepull. Though not as shiny as Ultegra and Dura-Ace, they're shiny enough, and really powerful. About 30g heavier per pair than single-pivot models. One thing we like about Shimanos over Campy is the caliper-mounted quick-release. It's not micro-adjusting, as on the Shimao 600 or SunTour Cyclone, but it works fine, anyway. Perfect choice for a sidepull-style Rivendell LongLow

STANDARD REACH

ITEM# 15-040

MEMBER PRICE \$57
NON-MEMBER \$60

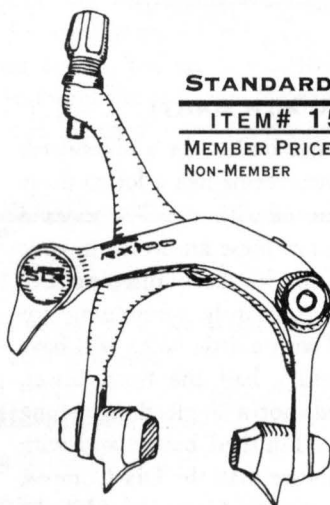

CALIPERS ONLY

SHIMANO 600 EX SIDEPULLS

What a find these are! New old stock from 1985. These Shimano 600 EX sidepulls are a window into the world of function and value that used to dominate Shimano's entire line. They have all the features you want in a sidepull: Micro-adjusting quick-release, rubber-donut barrel adjuster, rounded underarches for good fender clearance, and wheel guides for easy and quicker wheel re-installation. Besides that, they're engraved, not just screened, and the external springs are housed in low-friction, never-need-grease sleeves, for quiet and smooth returns, forever. Too good to be true? Well, the only hitch, and this is a small one, and read the whole thing before you write them off, is that the rear one uses a nut instead of an allen bolt. You can still use them on allen-style brake bridges, because we supply a really nifty sleeve-washer that fills in the gap just perfectly. Don't let that scare you! These are fantastic brakes. In twenty years you'll wish you'd bought two pair.

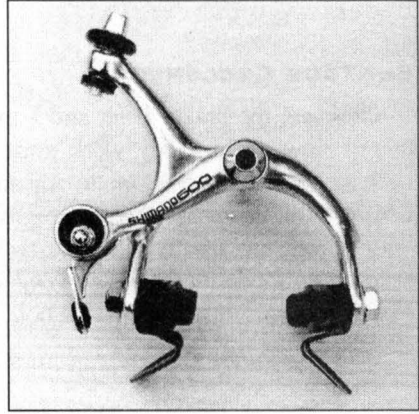

ITEM# 15-042
MEMBER PRICE \$50
NON-MEMBER \$52

Cantilevers

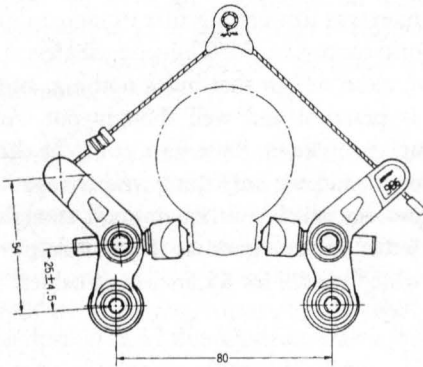

DIA COMPE 986 CANTI

Originally made for the 1990 Bstone MB-Ø, and for about 15 months after that, it was the most popular high-end cantilever on the market. The best deal you'll ever see, and they're good brakes. Ti Finish.

ITEM# 15-012
MEMBER PRICE \$25
NON-MEMBER \$27

SHIMANO XTR CANTI

Eighty-five dollars for a bikesworth of cantilevers seems like a lot to those of us still cursed with mid-'70s prices in our heads; but these are worth it, easy. Naturally, they've been discontinued, but we're constantly scrounging for them, and with a little luck, we'll have them in stock half the time. Silver, cold-forged, not a single thing wrong with these. Finished better, and with better hardware than the Dia-Compes, but at \$25, the Dia-Compes are still the better deal.

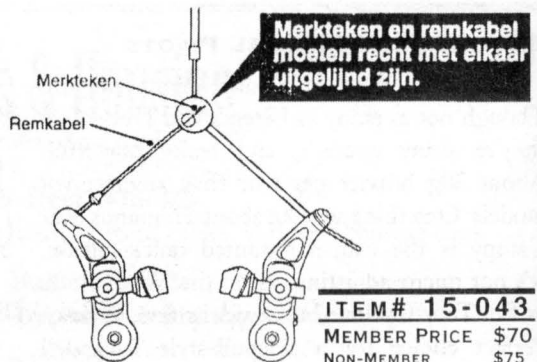

ITEM# 15-043
MEMBER PRICE \$70
NON-MEMBER \$75

BRAKE ACTUATORS

SUPERBE ROAD LEVERS

SunTour's best, pro-quality road lever, built without compromises, blah blah blah, AND with gum hoods! Gum rubber is pure latex, which sounds synthetic but isn't. It's the juice of the gum tree, and it makes surgical gloves, slingshot rubbers, and brake lever hoods. The synthetic hoods work as well and last longer, but nothing matches gum for looks, and a pair of these hoods will last you a good seven to ten years. Then you replace them, and if you can't get gum again, go for the blackies or see if Tim Zowada (616-348-5416) will sew you up some leather ones for the bargain price of \$36. Enough about the hoods! The levers beneath them are wonderfully simple, just six parts. These are non-aero, so you can move them around on the bar more easily, retape, switch stems or bars—all the normal activities that aero levers make difficult. You'll love the look of these, and the shape. Our first choice for a traditional road bike.

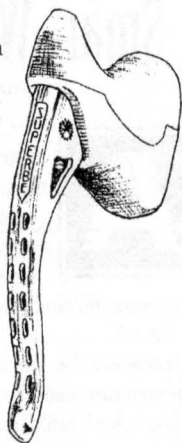

| | |
|---------------------|------|
| ITEM# 15-048 | |
| MEMBER PRICE | \$54 |
| NON-MEMBER | \$60 |

DIA-COMPE AGC 251 AERO ROAD LEVER

These were made when the U.S. dollar was strong, the Yen was weak, and Japanese makers didn't have to figure out how to cut costs. The black hoods fit snug, the metal is polished pretty well, and there are no obvious shortcuts. They don't have as large a body as modern aero levers, so if you have big hands and like big levers, these aren't the ones. But they are excellent levers, and good enough quality for any bike,



| | |
|---------------------|------|
| ITEM# 15-013 | |
| MEMBER PRICE | \$50 |
| NON-MEMBER | \$55 |



| | |
|---------------------|------|
| ITEM# 15-037 | |
| MEMBER PRICE | \$25 |
| NON-MEMBER | \$29 |

SHIMANO RX100 ROAD LEVERS (AERO)

Shimano's strength has always been the great values and perfect function of its midpriced parts, and the RX100 group is an example. These levers feel good, pull enough cable for cantilevers or sidepulls, and have metal, not plastic bodies. You can buy \$240 levers and not get that. If you want the most aero lever for the least money, these are it. Plenty of room for big hands.

MATHAUSER BRAKE SHOES

The best we've tried, but increasingly hard to get, so we reduced our selection to the ones least likely to be unavailable.

Basic road—\$4 (each shoe) ITEM #15-020

Fits all sidepulls. They look crude, but outstop all others.

Basic cantilever—\$20 (set of four) ITEM #15-017

Smart Wheels, Pretty Wheels, Spoked Wheels!



wheel laced with shiny, slender, sparkling silver spokes, with its strength-belying delicacy, is the universal symbol of bikes and bicycling, and both an engineering phenomenon, and a work of art.

Wheels are the last remaining bicycle part whose manufacture can't be totally robotized. There are robot wheel builders, but the spokes have to be stuck in the hub by hand. In the big factories, it's pretty amazing to watch. Young women grab six to ten spokes at a time in their fist, then fan them out just right, and stick them in the hub in one motion. A few rounds of that, taking a minute or so, and the hub's all full of spokes and ready to be joined to the rim. Once that's done, it goes into one of several types of wheel-robots, and out comes a fairly true and reasonably tight wheel. A guy at the other end catches it and makes it perfect, because a robot can do only so much.

As traditional and archetypal and symbolic as spoked wheels are, they're also the best kind. They're the best because there's a safety and repairability built into them that spokeless wheels don't have. If one spoke on a 32 to 48-spoke wheel breaks, big deal.

If two break, bigger deal, but it's not likely to happen on the same ride, and even if it does, you've still got 30 to 46 spokes to ride home on. Be careful around those 20-spoke wheels that are starting to pop up, though. They require heavier rims. With fewer spokes, each spoke is under greater tension (stress). If one breaks, the whole wheel will be so badly potato-chipped that you won't be able to ride two feet. All in all, it is not a best-of-both worlds kind of deal.

Expensive spokes cost \$0.35 each. A cheap spoke wrench costs four dollars, so fixing a spoked wheel costs less than a candy lunch, provided your effort doesn't make it worse. For guidance, buy Jobst Brandt's The Bicycle Wheel for twenty-four dollars, and now you're up to twenty-eight dollars. You replace the spokes, you're back on the bike, and you've just learned something valuable and added to your tool chest and library.

Spoked wheels suffer minor injuries well, but there's no such thing as a minor injury in a high

tech wheel. They cost a mint. They're faster in wind tunnels, and probably good for time trials, but for everyday riding they're dumb and expensive. The ultimate wheel, the absolute ultimate road wheel for sub-210 pound riders, is a parallel-sided Mavic MA2 laced with stainless spokes with brass nipples to a top quality hub. If it's a front wheel, it can have 32 or 36 spokes. If it's a rear wheel, it can have 32 to 40 spokes. It will cost, depending on some particulars, between \$150 and \$220, and will last you 15,000 to 35,000 miles, depending on how much wet pumice you ride through on your prolonged, rain-soaked, descents.

Rear wheels don't have to have more spokes than the fronts, but there's logic in doing it that way. The rear wheel is dishd, which makes it weaker; and it carries more weight, which makes it more vulnerable. When you see a pothole or a bump, you unweight the front wheel to get over it without crashing, and that puts more weight on the rear, just in time to smack into it. Four extra spokes back there make a lot of sense. Naturally, it's hard to find 36-spoke wheels on production bikes. It's common knowledge among product managers that dealers don't like bikes with 36 spokes, because customers don't like them, because everyone's trying to save weight in dumb ways.

There's nothing wrong with 36-spoke front wheels, either. For many riders it's overkill, but what's the penalty? An ounce and a half? A slight increase in wind resistance? The penalties with two extra spokes are no greater than the gains with two fewer.

The spoked wheel in 1999 is like the stone arrowhead in 1888. It's the last part of the bike that still has to be made with human labor. It's on the outs. Human labor in developed countries is costly, and companies will invest millions to get around it. In fifteen years the spoked wheel will be as common as toe clips are now.

Even IF the unspoked wheel evolves and surpasses the spoked wheel in reliability, and comes under it in price, and weighs even less, and all of the problems inherent in the current ones just dissolve, none of that will make a well-built spoked wheel any less pretty or reliable.

—Grant

HUBS AND WHEELS

PHIL WOOD HUBS

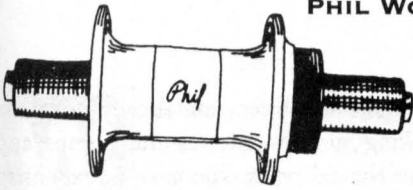

The highest compliment you can pay any hub is, "It's right up there with Phil Wood, almost." The Taj Mahal of hubs. Field-serviceable with two 5mm allens, but you'll probably never have to do it.

SUNTOUR XC 9000 32H FRONT, NO Q/R

SunTour's best in 1988, and right up there with a Phil, almost. If you build your own wheels and you ride 32-hole fronts, this is the best deal in the world. Don't let our super low price cause you any suspicion. These are a great deal. A quick-release is not included, although they are quick-release hubs.



ITEM# 18-052
MEMBER PRICE \$26
NON-MEMBER \$29

ITEM# SEE CHART

MEMBER PRICE \$97
NON-MEMBER \$110

| Hub | Item# |
|-----------------------|--------|
| Front 32° | 18-033 |
| Front 36° | 18-034 |
| Rear 32° x 130 x 6sp | 18-064 |
| Rear 32° x 130 x 7sp | 18-035 |
| Rear 36° x 130 x 6sp | 18-061 |
| Rear 36° x 130 x 7sp | 18-037 |
| Rear 32° x 135 x 6sp | 18-063 |
| Rear 32° x 135 x 7sp | 18-036 |
| Rear 36° x 135 x 6sp | 18-062 |
| Rear 36° x 135 x 7sp | 18-038 |
| Need something wacky? | Call! |

HAND-BUILT WHEELS!

Our wheels are built by two builders: Tim Parker or Joe Young. Each has more than 20 years of building experience, a stellar history, resume, and reputation, and it's highly unlikely that anybody is building wheels any better than these. Tim is in California, Joe is in New Hampshire (603 740 4539 or www.youngwheels.com). Look, shop, dig, snoop, fish around; you won't find better or more beautiful wheels. All wheels are 3-cross, with 14/15 butted DT spokes with brass nipples. Rear wheels are spaced for 7-speed freewheels, but of course accept sixers as well. Notes: The "plain" fronts are incredible bargains. The hubs are "right up there with Phil," but we got them cheaper and are passing that on. If you can live with two different hubs, they're a great deal. "Standard" and "stout" are relative terms. No "standard" or "stout" designations for the 26ers, since that sized wheel in this quality is always stout, anyway. Want a wheel that's not listed? Sixer, fiver, fixed, or 40H? Or need advice? Ask!

Rear Wheels

- 700c x 130 Phil Standard: Phil • 36 • MA2 (fits all standard road frames) \$188
- 700c x 130 Phil Stout: Phil • 36 • CR18 (fits all standard road frames) \$188
- 700c x 135 Phil Stout: Phil • 36 • CR18 (fits our larger A/R frames) \$188
- 26-inch x 135 Phil: Phil • 32 • CR18 (fits standard mtn frames and our A/R) \$188

Front Wheels

- 700c Plain Standard: SunTour XC9000 • 32 • MA2 \$115
- 700c Phil Standard: Phil • 32 • MA2 \$187
- 700c Plain Stout: Shimano XTR • 36 • CR18 \$115
- 700c Phil Stout: Phil • 36 • CR18 \$187
- 26-inch Phil: Phil • 32 • CR18 \$187
- 26-inch Plain Standard: SunTour XC9000 • 32 • CR18 \$115

Rims



We prefer traditional, reliable, box-section rims at least 20mm wide, with parallel braking surfaces. Much of a rim's lateral strength comes from its width, and a little wider is a lot stronger. Parallel braking surfaces bring out the best in any brake, especially cantilevers. We like the looks of silver, and stock only silver rims, but we don't have a major mission to rid the world of anodized or ceramic-coated models.

Many highly touted modern rims have machined sidewalls, to improve braking. But machining has its tradeoffs. When an aluminum extrusion is rolled into a rim, the sides very slightly crumple, and in theory the uneven surface needs to be smoothed out to improve braking. It sounds better than it is. Machining

sidewalls to perfect an already adequate braking surface removes the humps and thins the sidewalls. You have an expensive rim that comes pre-worn out! If you ride machined sidewalls, make sure they're also ceramic-coated, so you don't make the situation worse. All in all, Sun's sanded sidewalls are a better idea.

The best rim doesn't guarantee a reliable wheel, and a mediocre rim can be built into a completely reliable one. **You ride wheels, not rims**, and the builder makes more difference than the rim. Still, if you're going to start from scratch, you might as well start with good rims. The MA2 and CR18 certainly aren't the only good rims out there, but they're strong, consistent, and are our first choices. Too bad they don't come in asymmetrical versions, for rear wheels.

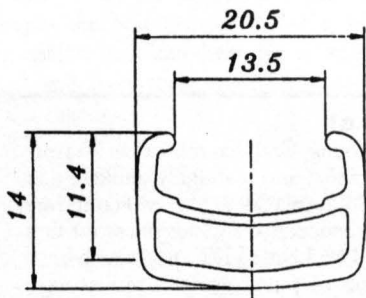

MAVIC MA2

Double eyelets, 20.5mm wide, 460g, and many smart riders—perennial megamiles, usually—who will ride no other road rim. Mavic says “for tires to 700x28,” and if that's an actual 28mm, it means at least any 700x32, although we ride them with 35s, no problem. Silver only, 32H or 36H.

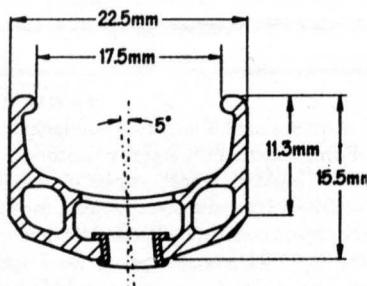

SUN CR 18

A stout, rim for rough roads, heavy riders, carrying loads, or all three. And it's not too heavy. A 700c one weighs 535g; a 26-incher weighs 450g. All the metal well-placed and worth it. Excellent rim!

26" x 32H

| |
|-------------------|
| ITEM# 18-049 |
| MEMBER PRICE \$27 |
| NON-MEMBER \$29 |

32H - MA2

| |
|-------------------|
| ITEM# 18-029 |
| MEMBER PRICE \$35 |
| NON-MEMBER \$37 |

36H - MA2

| |
|-------------------|
| ITEM# 18-030 |
| MEMBER PRICE \$35 |
| NON-MEMBER \$37 |

700C x 36H

| |
|-------------------|
| ITEM# 18-051 |
| MEMBER PRICE \$27 |
| NON-MEMBER \$29 |

700C x 40H

| |
|-------------------|
| ITEM# 18-059 |
| MEMBER PRICE \$27 |
| NON-MEMBER \$33 |

Tires



We like round cross-sections, because they corner better. In a touring or long-distance tire, extra rubber in the middle give better wear, and eventually you'll get a round cross section out of it, at which point it'll corner like a roundy. **We like light tires with high volume**, and you'll notice we don't sell any tire skinnier than 24mm. The whole idea of pneumatic tires is to ride on a cushion of air, and if your air volume is so low that you have to pump it up to 125 psi in order to protect the rim, it doesn't make lots of sense.

Bicycle tire theory and some lab tests say bike tires are too skinny to hydroplane, and that tread traps water and reduces grip on wet roads. But we've found a little **tread helps grip on wet roads**. Experiment yourself; maybe your roads are different than ours.

Since most of the riding we do involves fast, high speed cornering, where, if our tire sidewall blows out, we go into a ditch or smack hard into a rock, we're nuts for strong sidewalls. We sell only black-treaded tires with tannish sidewalls. In the case of the Cat. Pro models, those were made up special for us. In the following chart, the 26-inch tires were measured on a 22.5mm wide Sun CR18 rim. 700c tires were measured on a 20.5mm wide Mavic MA2 rim. We weighed one sample of each tire, and inflated one of each tire to maximum psi and let it sit for a week before measuring it; because tires tend to stretch. All of the tires we sell are made in Japan, and are excellent in all regards. They mount easily, stay on, wear well, and run perfectly true. Our return rate is zero. That's rare with rubber.

—Grant

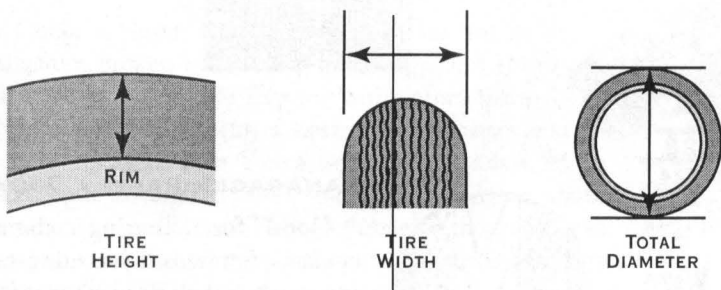

| TIRE SPEC CHART | | | | |
|--|--------|-------|--------|-----------|
| MODEL | HEIGHT | WIDTH | ØMM | WEIGHT |
| Panaracer Pasela-K 26 x 1.25 (kevlar) | 32 | 30.5 | 627 | 246/300g |
| Ritchey Crossbite 26 x 1.9 (kevlar) | 44 | 43 | 656 | 604g |
| Panaracer Cat 1 700 x 28 (kevlar/wire) | 25 | 24. | 680 | 275/320g |
| Avocet Road Slick 700 x 32 (wire) | 27 | 27 | 693.77 | 303g |
| Avocet Road Slick 700 x 35 (wire) | 30 | 32 | 699 | 370g |
| Panaracer Pasela 700x35 (kevlar/wire) | 31.5 | 31.5 | 692 | 369/411gg |

ITEM# 10-027

MEMBER PRICE \$22
NON-MEMBER \$26

▲
**Wire
Bead**

ITEM# 10-026

MEMBER PRICE \$30
NON-MEMBER \$34

▲
**Kevlar
Bead**

PANARACER CAT PRO 700x26 (25MM)

Last year it was labeled 700x28; this year the label is closer to correct, and the tire itself is unchanged.

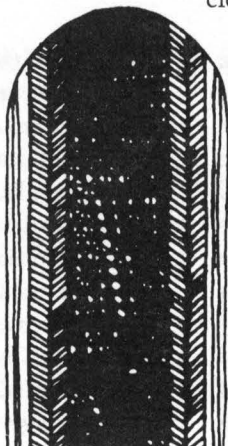

Good for: All-around road riding on decent surfaces. Reasonably light, exceptionally strong, runs absolutely true, and corners great. If you're ready to give up the hard skinnies, but you don't want to step up to the 700x32s, or if your frame won't fit them, this is the way to go. Kevlar or wire bead. A fantastic tire; you'll like it a lot. The tire says "inflate to 105 p.s.i."

AVOCET 700 x 32ROAD SLICK

Good for: All-around road riding on dry roads. These are the best dry-road cornering tires we've tried, and they both have sufficient volume to run as low as 80 p.s.i. if the surface calls for it.

It actually measures 27.5 or so. We used to sell the 700x35, but nobody ever bought it. We can order it for you, same price.

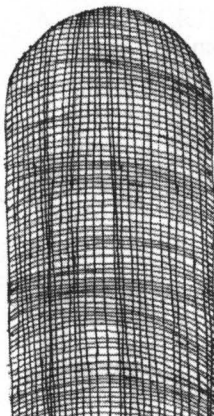

ITEM# 10-005

MEMBER PRICE \$26
NON-MEMBER \$27

ITEM# 10-028

MEMBER PRICE \$24
NON-MEMBER \$26

▲
**Wire
Bead**

ITEM# 10-011

MEMBER PRICE \$30
NON-MEMBER \$32

▲
**Kevlar
Bead**

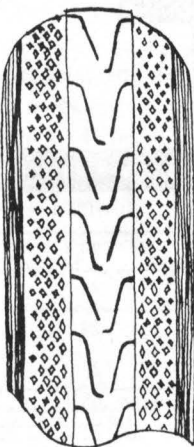

PANARACER PASELA 700x35

Good for: Touring, commuting, tandems, fire trails if you ride sanely, and any rough asphalt. It won't corner like an Avocet until the center rib wears down, but for straighter roads, and certainly for touring and distance riding, it's a better choice. Rave reviews from users. Durable, comfortable, long wearing—you put it on and forget about it. The tire says "inflate to 75p.s.i.," but based on our experience, that's conservative. Kevlar or wire bead.

TIRES

PANARACER PASELA 26 x 1.25

Good for: Fast road riding, light touring, commuting. This is the smallest 26-inch tire we sell, and it's still big enough to protect the rim on bad roads and natural bumps. Just slightly heavier than the skinniest 26 x 1-inch tires (from Ritchey and Continental), but much more volume, for better rim protection and comfort. Tire says inflate to 85psi. That sounds low, but in this tire it works well.

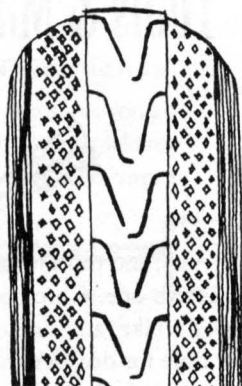

| |
|---------------------|
| ITEM# 10-032 |
| MEMBER PRICE \$25 |
| NON-MEMBER \$28 |

▲
**Wire
Bead**

| |
|---------------------|
| ITEM# 10-010 |
| MEMBER PRICE \$30 |
| NON-MEMBER \$32 |

▲
**Kevlar
Bead**

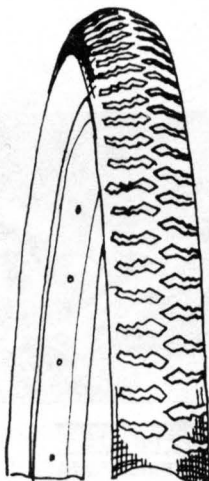

RITCHEY CROSSBITE 26 x 1.9

Good for: Combination road and trailriding, trail riding in general, heavily loaded or rough touring.

Tire people say that for maximum performance, you need to tailor the tread and rubber compound to the particular terrain, and maybe for competition you do. But for all-around trail riding mixed with street, this one works great. Doesn't buzz on asphalt.

| |
|---------------------|
| ITEM# 10-015 |
| MEMBER PRICE \$32 |
| NON-MEMBER \$34 |

COBBWORKS PATCH KITS

Mike Cobb, a clever Northwesterner, makes patch kit containers from broken inner tubes and snaps, and stuffs them full of what you need to fix a flat with, minus the tire levers. Namely, rubber cement, a square of sandpaper, and genuine Rema patches. Kim Young, some of you know, was a Bstone catalogue covergirl (1994), and runs BICAS, a youth bicycle mechanic organization. They go through a thousand or so patches a year, and she says the only patches worth poop are Remas. France and U.S.A.

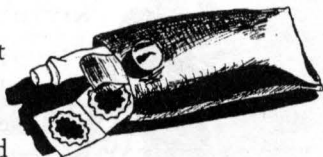

| |
|---------------------|
| ITEM# 10-012 |
| MEMBER PRICE \$4 |
| NON-MEMBER \$5 |

PRESTA-VALVE TUBES, \$4 EA.

700c Item #10-004

BLACK. 97G MINIMUM, 120G MAXIMUM. FITS FROM 700 X 23 TO 700 X 35.

26 Skinny Item #10-003

BLACK. 93G MIN; 135 MAX. THE PERFECT TUBE FOR TIRES UP TO 26 X 1.25.

26 Medium Item #10-002

BLACK. 140G MIN, 165G MAX THE BOX SAYS IT'S FOR TIRES BETWEEN 1.5" AND 2.2-INCHES.

26 Fat Item #10-001

BLACK. 168G MIN, 178G MAX. FOR BIG TIRES.

Tools & Maintenance

HOZAN Y-WRENCH

Everybody needs a Y wrench, and this Hozan is the best and most expensive one. Chromed steel, precise, useful all over a bike, and one of those tools you use all the time for decades and don't appreciate until you can't find it. Every bike shop uses one, and every home mechanic needs one.

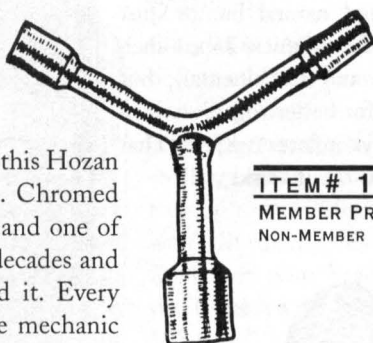

| | |
|---------------------|------|
| ITEM# 19-023 | |
| MEMBER PRICE | \$10 |
| NON-MEMBER | \$11 |

ELDI No. 61 PEDAL WRENCH

Campy, schmampy; VAR, schmar; Park, schmark; Wrench Force, schmrench force. The best pedal wrench is the venerable ELDI No. 61. In fact, say, "No. 61" around an old-timer and her eyes will wellup with tear saliva, as she recalls glorious battles fought and won with her trusty and stalwart "sixty-one." It's been around forever, and you can count on passing this one down to your next generation of "sixty-one-o-philes."

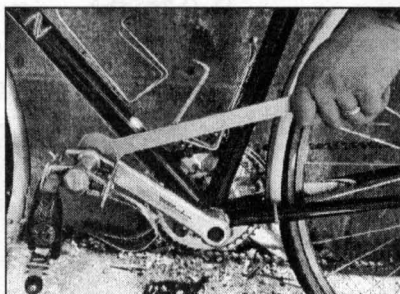

| | |
|---------------------|------|
| ITEM# 19-051 | |
| MEMBER PRICE | \$14 |
| NON-MEMBER | \$15 |

NITTO STEM PRY

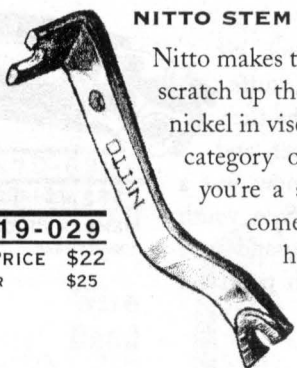

Nitto makes this tool for prying open the stem clamp, so's you don't scratch up the bar sleeve when you put it in. It works better than a nickel in vise grips, or a screwdriver, but nevertheless falls into the category of "non-essential tools for the home mechanic." If you're a shop guy-girl, though, isn't the peace of mind that comes from knowing you'll never scratch your customer's handlebars worth the \$20? Double ended, to fit most stems.

| | |
|---------------------|------|
| ITEM# 19-029 | |
| MEMBER PRICE | \$22 |
| NON-MEMBER | \$25 |

THE TYRE LEVER FORMERLY KNOWN AS VAR

These won't pinch tubes or mark up rims. They're French, they used to be marketed as VAR brand lever, and they are by far the best tire lever I've used for 32mm wide and skinnier tires. I'm now using the Eldi levers on larger tires.

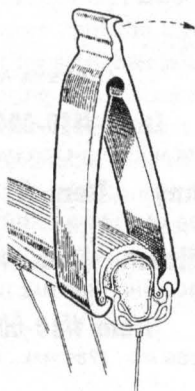

| | |
|---------------------|------|
| ITEM# 19-045 | |
| MEMBER PRICE | \$9 |
| NON-MEMBER | \$11 |

4MM BONDHUS (BALL-HEAD) ALLEN WRENCHES

Handy for bottle cages and racks. The ball-head lets you go in at a slight angle, a real blessing when mounting racks or bottle cages. German, top quality, and when you need one, a standard wrench will drive you bananas. Get it!

| |
|---------------------|
| ITEM# 19-011 |
| MEMBER PRICE \$6 |
| NON-MEMBER \$7 |



ELDI TIRE LEVERS

Peter's favorite lever on any tires, and Grant's on middies and fatties. Unlike the cheap steel levers of yore, these have smoothish rounded edges, and don't harm rims.

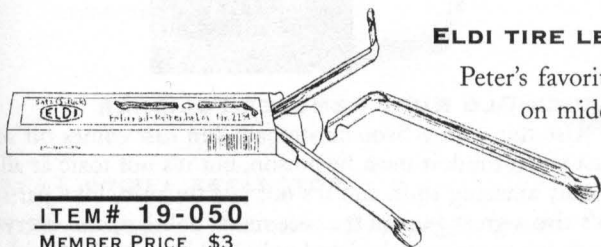

| |
|---------------------|
| ITEM# 19-050 |
| MEMBER PRICE \$3 |
| NON-MEMBER \$4 |

BOESHIELD T-9

This heinous-sounding stuff was developed to keep Boeing's airplanes from rusting; and with Boeing's budget, you can imagine they came up with a good formula. In the chainlube department, we find it every bit as good as White Lightening. It's wax-based, so as chain lubes go, it's relatively tidy and doesn't tend to collect gunk as fast as oil-based lubes. It's not quite as tidy as White Lightening, but an application lasts longer. It's good.

4 oz drip bottle

| |
|---------------------|
| ITEM# 13-033 |
| MEMBER PRICE \$7 |
| NON-MEMBER \$8 |

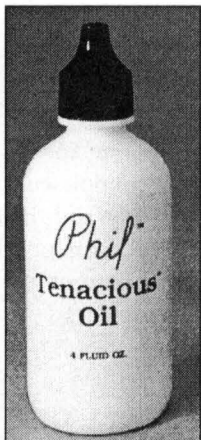

PHIL TENACIOUS OIL

The slowest-running oil on earth, which makes it good for places where you really should use grease, but you either don't have any, or you're too lazy to overhaul and regrease it—just use some of this and you'll be all-right. Good to use on any new pedals. Run a squirm of oil around the bearings, let it soak through, and put the cap back on. Grease is better, this is quicker.

| |
|---------------------|
| ITEM# 31-013 |
| MEMBER PRICE \$6 |
| NON-MEMBER \$7 |

FRAME SAVER

East Haddam, CT. frame builder Peter Weigle developed this to protect steel frames from rusting out from the inside. It works so well and is so cheap (\$3 to \$4 per frame), why not? We've tested 7 other anti-rust goops, and this one is the clear winner. It takes five minutes to spray the frame, and ten minutes to clean up afterward. Use Simple Green or WD-40 or 409 for that.

ITEM# 31-006

MEMBER PRICE \$12
NON-MEMBER \$13

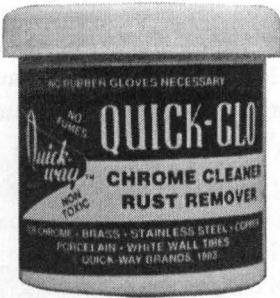
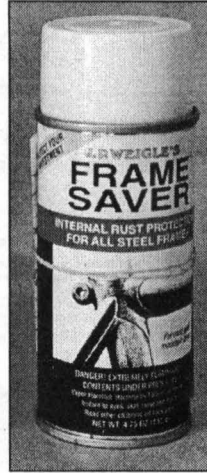

QUICK-GLO RUST REMOVER/POLISHER

Use this with a Scotchbrite pad, and rust comes off so fast you'll think it must be poison, but it's not toxic at all. Really amazing stuff, and it's not just for rusty bike parts. It's also a great general purpose metal polisher, and everybody has some tarnished and ugly-looking metal around.

ITEM# 31-015

MEMBER PRICE \$6
NON-MEMBER \$7

BEESWAX

From local bees. Tons of uses on and off a bike. Put it on all threaded surfaces to prevent loosening. Make emergency cable end-caps, to prevent fraying. Put it on shoelaces to prevent loosening. Strengthen string, lubricate screws and nails. First, break off a small chunk and knead it till it's soft and gummy. It'll harden up again, but will never get crumbly, and will always be ready to rub into threads (like pedal dust caps or headset locknuts).

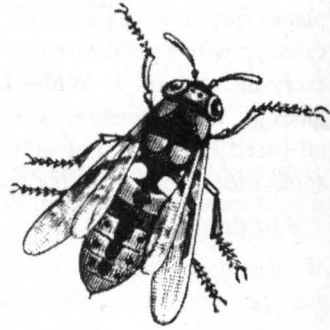

ITEM# 31-002

MEMBER PRICE \$3
NON-MEMBER \$4

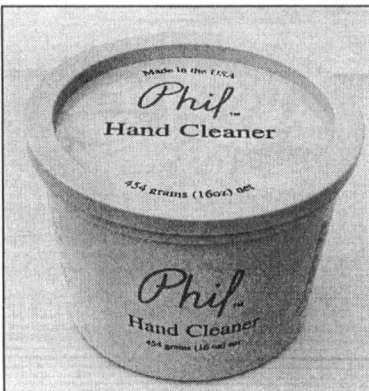

PHIL HAND CLEANER

Second only to Phil Oil in the category of "Cheapest Way To Own A Phil Something." It's also the best hand cleaner we've tried, and we fancy ourselves hand-cleaner connoisseurs. This grainy brown stuff gets out the grime and rinses off in a jiffy. It's all natural, doesn't smell, won't hurt nothing, and when it's all used up, you've got yourself a plastic celeste-colored bowl.

ITEM# 31-038

MEMBER PRICE \$6
NON-MEMBER \$7

Safety Stuff & Another Water Bottle Cage

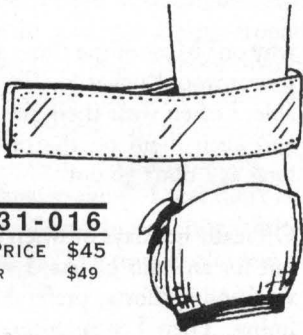

ITEM# 31-016
MEMBER PRICE \$45
NON-MEMBER \$49

ACME ANKLE REFLECTOR

More surface area and reflectivity than any other, and if you think those things don't matter, try again. The best ankle band made, and they fit arms, too.

ACME WHEEL REFLECTOR

White Reflexite with velcro. Each weighs about 4g and goes on and off in seconds. Doesn't throw the wheel off balance or mess with the spoke tension. There's no reason other than vanity to ever ride without them. Certainly, use them at night.

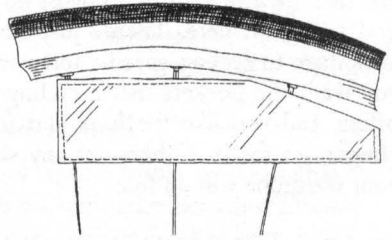

ITEM# 21-080
MEMBER PRICE \$5
NON-MEMBER \$7

CHUCK HARRIS'S REAR VIEW MIRROR

The best mirrors available—they keep their adjustment over long miles and bad ground. Chuck Harris makes them out of recycled materials, and he's made more than 60,000 of them over the years, so you can bet he has it down. The arm is a spoke.

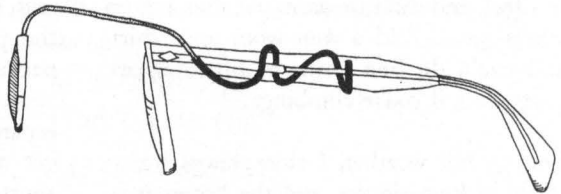

WIRE FRAMES
ITEM# 21-023
MEMBER PRICE \$16
NON-MEMBER \$17

PLASTIC FRAMES
ITEM# 21-022
MEMBER PRICE \$16
NON-MEMBER \$17

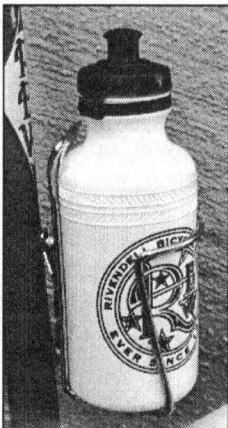

ALE BOTTLE CAGE

One of cycling's great mysteries is the popularity of aluminum bottle cages. They mark up bottle and make them so ugly you don't want to touch them. Steel and titanium and plastic don't do that, but Ti cages cost a lot, and plastic ones are ugly. This one is chromed steel, about 100g. Sturdy, reliable, looks great, and no amount of jiggling will blacken the bottle. It ought to last a decade. 93g.

ITEM# 29-001
MEMBER PRICE \$10
NON-MEMBER \$14

Sensible System for Summer



we sell cycling-specific clothing, but lack of it won't ruin an otherwise good ride. I'm not talking about some 24-hour road ride, or some kind of marathon; just a regular half-hour to four-hour bicycle ride. The guy I know who rides the most rides almost exclusively in a long-sleeved oxford cloth shirt. My Pal Jeff rides in a long-sleeved cotton work shirt, and half the time I do, too. There's no rebellion going on here. There's just no great advantage to cycling-specific torso-wear. If you want the pockets that a cycling jersey offers, and you like the look and fit of a clinger, go for it. Otherwise, any shirt in your wardrobe will do fine.

Don't let scientists and techies scare you off cotton. It gets sweaty and stays wet, which means you leave it at home in cold or unpredictable weather. But for one-to-three-hour fairweather rides in known territory and mild to warm weather, cotton works great. Add a thin wool undershirt, and you'll do fine down to fifty degrees. Forty-two, if you're climbing.

During hot weather, I ride almost exclusively in long-sleeves, and the hotter it is, the more likely you'll find me shrouded in seersucker. Seersucker is a hot-weather fabric, because it's crinkliness keeps it off your skin; and it's usually really light, to boot. The long sleeves keep the sun off my skin, which is more pleasant than rubbing greasy SPF 30 into my arm hair. What I lose in the wind not being able to cool me off, I gain in shade. Given a choice, go for the long-armed versions—they're made for cyclists!

Cycling shorts make more of a difference than cycling tops. I can't stand lycra shorts. Partly it's because I'm getting fatter, but mostly it's because I don't feel natural in them. I'd never wear them off the bike, so

why on? Most of the time, most of the year, I wear wool Kuchariks. They're so comfortable, I often wear them for a morning ride, and keep them on the rest of the day, as long as I don't go out.

On really hot days or when I just want to go out for an hour or less, I wear baggy plaid weekender shorts, preferably with a mesh lining. Then I wear either regular cotton undies under them (if it'll be a short ride), or those Andiamo! jobs—the cycling-specific underwear that promises to “turn any pair of shorts into cycling shorts!” They come in two versions: mid-thigh and brief. Some are white, some are black. They're padded. Being tight and stretchy and synthetic, they don't feel all that cozy, but they add some comfort on longer rides, and at least I can keep them hidden with the baggies.

You can get cycling-specific baggies, but it seems to me that's sort of like buying shoes with built-in sox. The only benefit of having the padded part integral with the baggy part is that the maker can call them cycling shorts. When the shorts and undies are separate, you can ride, wash the undies, and get another several wearings out of the shorts. A familiar and sensible concept! And, you can wear the shorts by themselves when you aren't riding.

I ride a lot on Mt. Diablo, which teems with cyclists every weekend, because if you like pretty climbs and fun turns on descents, it's the best cycling road in the world. Usually it's Jeff and I, and we're the worst-dressed cyclists on the mountain. There's a turnaround halfway up, and riders stop there to rehydrate or wait for their friends. I always feel disreputable in my non-uniform, and it probably does Rivendell no good, to see the bikes associated with such slob. Jeff is usually better-dressed than I am, but not by a lot.

—Grant

WOOL SHORTS (KUCHARIK)

Kucharik has been making cycling clothing since 1934, and these are the best wool shorts we've ridden. They still ride up like the wool shorts of old, but not as much, and most importantly, they don't ride down or give you a ring around the thigh, or that "too bad I have to pour myself into a spandex suit to enjoy the sport I love" feeling. You won't wear plastic after wearing these. Superwash wool with a fake chamois. They fit better after the first washing. These don't last as long as thick synthetic shorts. In time, the fabric tears at the edge of the chamois. The tears don't seem to grow.

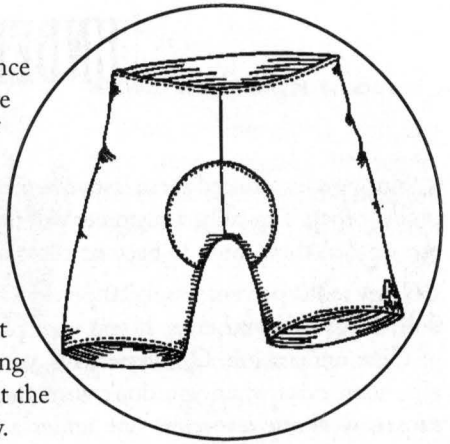

S: to 29w (#21-038)

M: to 33w (#21-036)

L: to 36w (#21-034)

XL: 37-40 (#21-040)

| ITEM# | SEE SIZES |
|--------------|-----------|
| MEMBER PRICE | \$58 |
| NON-MEMBER | \$63 |



KUCHARIK SS JERSEY

Made to our specification by Kucharik. Different from the standard Kuchariks. These are grey with blue cuffs and collar, with a 7-inch zipper, non-elasticated hem. Three pockets in back. Cut fuller than most jerseys. They shrink almost two sizes if you wash and dry them warm. If you wash cold and air dry, they'll shrink a size. If you want it loose, order a size up.

| ITEM# | SEE SIZES |
|--------------|-----------|
| MEMBER PRICE | \$80 |
| NON-MEMBER | \$85 |

M: 36-38 (#21-109)

L: 40-42 (#21-110)

XL: 42-44 (#21-111)

XXL: 44-46 (#21-112)

XXXL: 48-50 (#21-122)

SMART WOOL (BRAND) SOCKS

Eighty percent Superwash wool with 20 percent nylon. The bottoms are thicker than the tops, the toes are tough, they don't shrink, they wear forever. Three years, at least.

M: M 4.5 to 8; W 6 to 9.5 (#21-082)

L: M8.5-11.5; W 10 to 12 (#21-081)

XL: M 12-15; W 13.5-16.5 (#21-083)

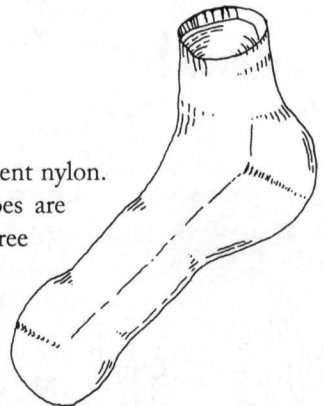

| ITEM# | SEE SIZES |
|--------------|-----------|
| MEMBER PRICE | \$9 |
| NON-MEMBER | \$10 |

UNDERWOOLIES!

Since we introduced these last year, they've quickly become our most popular item besides pine tar soap. Typically, a customer will try out one, like it, then buy two more just like it and one of the others. Sure to become the most worn items in your clothing mound.

They're 90 percent wool, 10 percent nylon, but feel like 96/4. Soft and cozy, and they don't stink like synthetics. If you wear plastic jerseys and get chilled on descents, wear one of these underneath. On warm days, you can wear one instead of a regular jersey. On hot afternoon rides when you don't want the sun to bake you and you don't want to freeze at sunset, wear the sleeveless one under a lightweight, long-sleeve cotton t-shirt or button-down. These thin woolies are the most versatile cycling garments you can own. Great for cold weather cycling, wood chopping, knot tying, hiking, running, skiing, skipping, shopping. All are well made in Nova Scotia, and very nice.

SHORT SLEEVE THIN WOOLY

Want to ride in wool, but don't want to pop for a real jersey? Here's a cheap solution. So comfortable and versatile. Lacks a zipper and pockets, but for \$24, who cares? Equally good general wear, too.

- S: #21-117
- M: #21-118
- L: #21-119
- XL: #21-120

| ITEM# | SEE SIZES |
|--------------|-----------|
| MEMBER PRICE | \$23 |
| NON-MEMBER | \$27 |



SLEEVELESS THIN WOOLIES

Wear this under a cotton shirt or any jersey. You won't overheat on the climb, and it'll prevent freezing a cool descent.

- S: #21-113
- M: #21-114
- L: #21-115
- XL: #21-116

| ITEM# | SEE SIZES |
|--------------|-----------|
| MEMBER PRICE | \$16 |
| NON-MEMBER | \$19 |



LONG SLEEVE THIN WOOLY

Ideal on cooler days, but works well up to 90-degrees, too, since it's so thin. We wear them alone or under other layers; like under the scratchy grey job on the right. Good pajama top, too.

- S: #21-123
- M: #21-124
- L: #21-125
- XL: #21-126

| ITEM# | SEE SIZES |
|--------------|-----------|
| MEMBER PRICE | \$28 |
| NON-MEMBER | \$32 |

CLOTHING

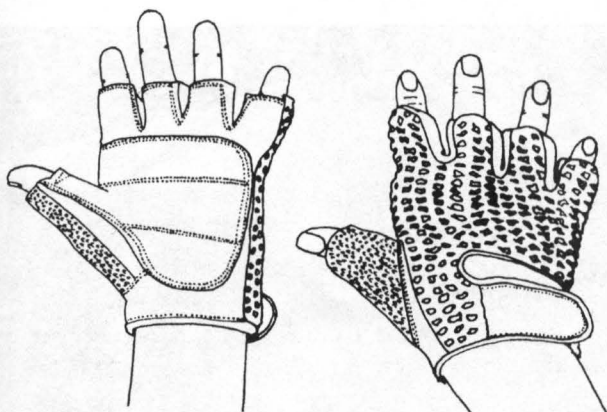

ACME COW SKIN GLOVES

Most cycling gloves look like they were designed by superheroes for superheroes. These are made to our spec, and just the opposite. Simple, Pakistani-made cotton crochet-backed gloves with cowskin palms and terry-cloth thumb.

S: # 21-084

M: # 21-085

L: # 21-086

XL: # 21-087

| ITEM# | SEE SIZES |
|--------------|-----------|
| MEMBER PRICE | \$15 |
| NON-MEMBER | \$16 |

RIVENDELL CYCLING CAP

Great shape, nice design, and every 4 months we have a new hue. No choice, but we won't pick anything bad. If you wind up with two of the same, that may be fine!

| ITEM# | 21-130 |
|--------------|--------|
| MEMBER PRICE | \$9 |
| NON-MEMBER | \$10 |



BIG SMITH SHOP APRON

Big Smith has been making work clothes since 1916, and it's doubtful this apron has changed since then. You pull on the waist cords to adjust the neck loop, then wrap the ends around your back and tie it off in front. Two lower pockets hold stuff, and the upper one holds pencils and allens. It's sewn at the top only, so you don't lose things when you lean over. Brown duck.

| ITEM# | 22-041 |
|--------------|--------|
| MEMBER PRICE | \$17 |
| NON-MEMBER | \$18 |

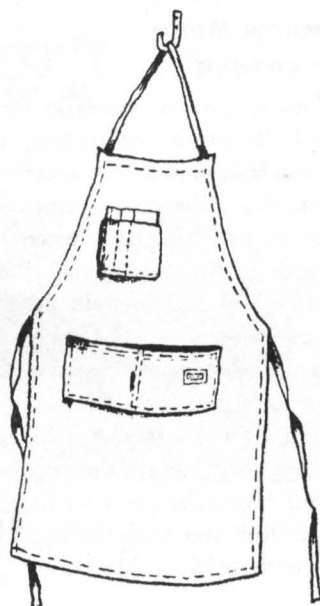

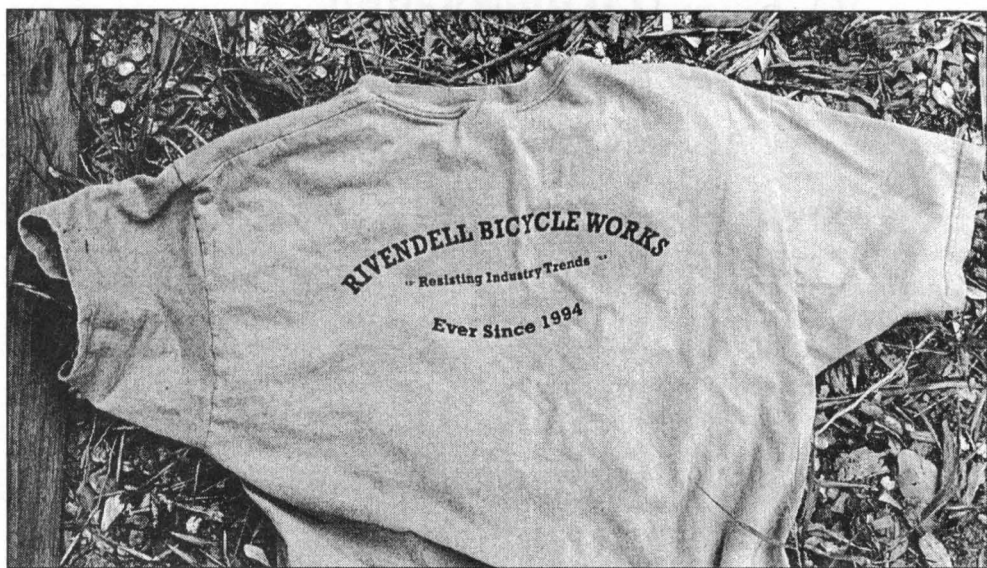

HOUSE T-SHIRT

All cotton, Rivendell logo on the front, with a catchy slogan on back. Various colors (natural, grey-green, or grey-blue) and (L through XXL), all depending on the time of year. You pick the size and take whatever color and slogan happens to be in stock then.

L: # 22-019

XL: # 22-021

XXL: # 22-022

| ITEM# | SEE SIZES |
|--------------|-----------|
| MEMBER PRICE | \$14 |
| NON-MEMBER | \$16 |

TOMBOW MONO MP ERASER

This is the best eraser in the world. Almost no palimpsest, if you can believe it. Bible paper?—no problem. Cheap newsprint?—same no problem. Back when I worked at Bridgestone, all the Japanese guys had them. I tried one and found out why. On my trips to Japan I'd always come back with a few dozen. I'm down to three and Tombow USA doesn't carry them, so I had a friend buy these for me at retail in Japan. That's why they're \$2 each; but what else can you buy for \$2 that's the very best of its kind in the world? Especially good for kids. Eberhard Faber and Magic Rub and Staedtler-Mars have a lot to envy in the Tombow Mono MP eraser.



| ITEM# | 31-026 |
|--------------|--------|
| MEMBER PRICE | \$2 |
| NON-MEMBER | \$3 |

Soaps! \$4 per Bar

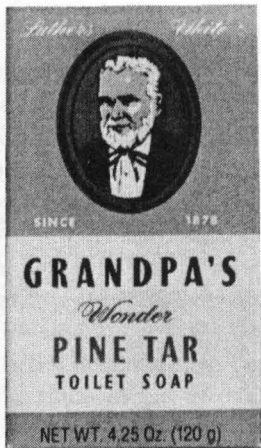

PINE TAR SOAP

Made the same way since 1878, with a strong pine tar scent that cuts through the stench, but washes off thoroughly. Most women hate the smell, most men love it. Many washers use it to cure or appease skin problems, or as a contact lens wash; and besides that, it's also the best shampoo you'll find. It never builds up, doesn't strip your hair of oils, but gets out the grease. Our best selling item by far. Hefty, 4oz. cake.

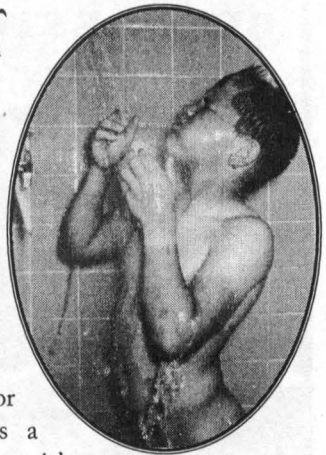

ITEM# 25-001

MEMBER PRICE \$4
NON-MEMBER \$5



PATCHOULI SOAP

Patchouli is a plant extract used a lot in India for centuries, and popularized in this country by hippies in the mid-'60s. Lather up with this, and the smell lingers. Mix it with Pine Tar.

ITEM# 23-005

MEMBER PRICE \$4
NON-MEMBER \$5

LIP IVO

If you ever use lip stuff, you might as well try the original, first made in 1903. It's vanilla with peppermint, and unlike real Chapstick, it's non-addictive. We sell it because I can't find it anywhere else. Not too waxy or slimy, and it actually stays on. It's only a dollar, for crying out loud, and most people who try it come back for more.



ITEM# 31-009

MEMBER PRICE \$1
NON-MEMBER \$2

∞ RIVENDELL BICYCLE WORKS ∞

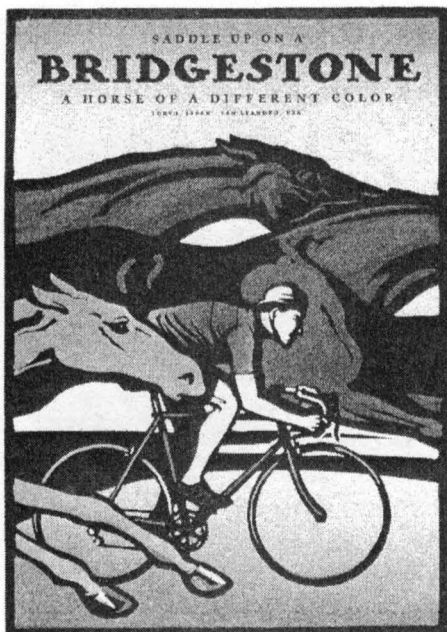

BSTONE POSTER

At the turn of the century, posters were the main advertising medium for bicycles, and these two, by English linoleum-block print artist Christopher Wormell, are the equals of any. They were commissioned during the last two years of Bstone. They're 24-inches wide, 36-inches tall, and have sold in poster-specialty shops for \$17. Dwindling supply.

ITEM# 31-004
 MEMBER PRICE \$8
 NON-MEMBER \$9



HERON POSTER

An 18 x 24-inch colored pencil poster by 19-year old Lafayette, CA artist Andrew Denman, who also drew the Carradice Boxy bag somewhere else in this catalogue. The colors are neat, and there's lots to look at.

ITEM# 24-031
 MEMBER PRICE \$7
 NON-MEMBER \$8

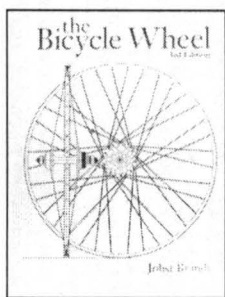

THE BICYCLE WHEEL

Wheel-building theory and practice, and widely regarded as the definitive book on wheels. Good for wheelbuilders and non-wheelbuilders. The spoked wheel is a beautiful thing, and a symbol of the bicycle, and this book makes you appreciate it even more. Written by Jobst Brandt.

ITEM# 23-008
MEMBER PRICE \$25
NON-MEMBER \$26

TOURING BIKES

English framebuilder-physicist Tony Oliver's look at bike frames— what goes into them, what's good, what's bad. We don't buy his whole program (he likes brazed-on front derailleurs because he's anal about clamping things onto paint, for instance), but that's a difference of opinion, not a criticism. This book will open your eyes, educate you, fascinate you, and you'll probably buy one as a gift later on, after reading it yourself. There's no way you'll regret buying this book. If your spouse is into bikes and you don't know what to buy for him/her, but you happen to be reading this right now and you have \$40 burning a hole, this is a sure hit.

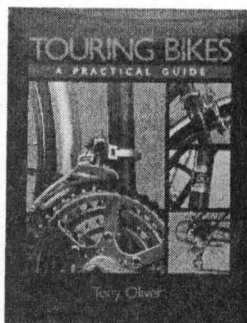

ITEM# 23-002
MEMBER PRICE \$40
NON-MEMBER \$49



A BOOK OF NONSENSE

Edward Lear's magnum opus, first published in 1848. Limericks, short stories, a dictionary, stuff on animals, and a botany lesson. A perennial best-seller here, if you can believe it. We offer a double-your-money-back guarantee if you don't love this book, but you pay the return postage—an offer we've been taken up on just 3 times out of more than 200 books sold. Edward Lear was a genius, and this book appeals to all ages, for various reasons.

ITEM# 23-004
MEMBER PRICE \$14
NON-MEMBER \$16

THE COMPLETE BOOK OF KNOTS

Everyone should know how to tie at least 10 knots, but most people know just five, and they don't always get them right. This book, written by a guy who edited the Ashley book, is the least-overwhelming, best knot book I've read. It tells the history and best use of tons of knots, and has the best instructions I've seen for the venerable Monkey's Fist, always a party favorite.

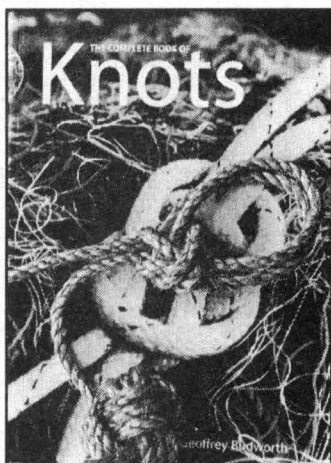

ITEM# 23-011
MEMBER PRICE \$19
NON-MEMBER \$20

GEAR CHART 700c/27 WHEEL

CHAINRING

REAR COG

| | 20 | 22 | 24 | 25 | 26 | 27 | 28 | 29 | 30 | 31 | 32 | 33 | 34 | 35 | 36 | 37 | 38 | 39 | 40 | 41 | 42 | 43 | 44 | 45 | 46 | 47 | 48 | 49 | 50 | 51 | 52 | 53 | 54 |
|----|----|----|----|----|----|----|----|----|----|----|----|----|----|----|----|----|----|----|----|-----|-----|-----|-----|-----|-----|-----|-----|-----|-----|-----|-----|-----|-----|
| 11 | 49 | 54 | 59 | 61 | 64 | 66 | 69 | 71 | 74 | 76 | 79 | 81 | 83 | 86 | 88 | 91 | 93 | 96 | 98 | 101 | 103 | 106 | 108 | 110 | 113 | 115 | 118 | 120 | 123 | 125 | 128 | 130 | 133 |
| 12 | 45 | 50 | 54 | 56 | 59 | 61 | 63 | 65 | 68 | 70 | 72 | 74 | 77 | 79 | 81 | 83 | 86 | 88 | 90 | 92 | 95 | 97 | 99 | 101 | 104 | 106 | 108 | 110 | 113 | 115 | 117 | 119 | 122 |
| 13 | 42 | 46 | 50 | 52 | 54 | 56 | 58 | 60 | 62 | 64 | 66 | 69 | 71 | 73 | 75 | 77 | 79 | 81 | 83 | 85 | 87 | 89 | 91 | 93 | 96 | 98 | 100 | 102 | 104 | 106 | 108 | 110 | 112 |
| 14 | 39 | 42 | 46 | 48 | 50 | 52 | 54 | 56 | 58 | 60 | 62 | 64 | 66 | 68 | 69 | 71 | 73 | 75 | 77 | 79 | 81 | 83 | 85 | 87 | 89 | 91 | 93 | 95 | 96 | 98 | 100 | 102 | 104 |
| 15 | 36 | 40 | 43 | 45 | 47 | 49 | 50 | 52 | 54 | 56 | 58 | 59 | 61 | 63 | 65 | 67 | 68 | 70 | 72 | 74 | 76 | 77 | 79 | 81 | 83 | 85 | 86 | 88 | 90 | 92 | 94 | 95 | 97 |
| 16 | 34 | 37 | 41 | 42 | 44 | 46 | 47 | 49 | 51 | 52 | 54 | 56 | 57 | 59 | 61 | 62 | 64 | 66 | 68 | 69 | 71 | 73 | 74 | 76 | 78 | 79 | 81 | 83 | 84 | 86 | 88 | 89 | 91 |
| 17 | 32 | 35 | 38 | 40 | 41 | 43 | 44 | 46 | 48 | 49 | 51 | 52 | 54 | 56 | 57 | 59 | 60 | 62 | 64 | 65 | 67 | 68 | 70 | 71 | 73 | 75 | 76 | 78 | 79 | 81 | 83 | 84 | 86 |
| 18 | 30 | 33 | 36 | 38 | 39 | 41 | 42 | 44 | 45 | 47 | 48 | 50 | 51 | 53 | 54 | 56 | 57 | 59 | 60 | 62 | 63 | 65 | 66 | 68 | 69 | 71 | 72 | 74 | 75 | 77 | 78 | 80 | 81 |
| 19 | 28 | 31 | 34 | 36 | 37 | 38 | 40 | 41 | 43 | 44 | 45 | 47 | 48 | 50 | 51 | 53 | 54 | 55 | 57 | 58 | 60 | 61 | 63 | 64 | 65 | 67 | 68 | 70 | 71 | 72 | 74 | 75 | 77 |
| 20 | 27 | 30 | 32 | 34 | 35 | 36 | 38 | 39 | 41 | 42 | 43 | 45 | 46 | 47 | 49 | 50 | 51 | 53 | 54 | 55 | 57 | 58 | 59 | 61 | 62 | 63 | 65 | 66 | 68 | 69 | 70 | 72 | 73 |
| 21 | 26 | 28 | 31 | 32 | 33 | 35 | 36 | 37 | 39 | 40 | 41 | 42 | 44 | 45 | 46 | 48 | 49 | 50 | 51 | 53 | 54 | 55 | 57 | 58 | 59 | 60 | 62 | 63 | 64 | 66 | 67 | 68 | 69 |
| 22 | 25 | 27 | 29 | 31 | 32 | 33 | 34 | 36 | 37 | 38 | 39 | 41 | 42 | 43 | 44 | 45 | 47 | 48 | 49 | 50 | 52 | 53 | 54 | 55 | 56 | 58 | 59 | 60 | 61 | 63 | 64 | 65 | 66 |
| 23 | 23 | 26 | 28 | 29 | 31 | 32 | 33 | 34 | 35 | 36 | 38 | 39 | 40 | 41 | 42 | 43 | 45 | 46 | 47 | 48 | 49 | 50 | 52 | 53 | 54 | 55 | 56 | 58 | 59 | 60 | 61 | 62 | 63 |
| 24 | 23 | 25 | 27 | 28 | 29 | 30 | 32 | 33 | 34 | 35 | 36 | 37 | 38 | 39 | 41 | 42 | 43 | 44 | 45 | 46 | 47 | 48 | 50 | 51 | 52 | 53 | 54 | 55 | 56 | 57 | 59 | 60 | 61 |
| 25 | 22 | 24 | 26 | 27 | 28 | 29 | 30 | 31 | 32 | 33 | 35 | 36 | 37 | 38 | 39 | 40 | 41 | 42 | 43 | 44 | 45 | 46 | 48 | 49 | 50 | 51 | 52 | 53 | 54 | 55 | 56 | 57 | 58 |
| 26 | 21 | 23 | 25 | 26 | 27 | 28 | 29 | 30 | 31 | 32 | 33 | 34 | 35 | 36 | 37 | 38 | 39 | 41 | 42 | 43 | 44 | 45 | 46 | 47 | 48 | 49 | 50 | 51 | 52 | 53 | 54 | 55 | 56 |
| 27 | 20 | 22 | 24 | 25 | 26 | 27 | 28 | 29 | 30 | 31 | 32 | 33 | 34 | 35 | 36 | 37 | 38 | 39 | 40 | 41 | 42 | 43 | 44 | 45 | 46 | 47 | 48 | 49 | 50 | 51 | 52 | 53 | 54 |
| 28 | 19 | 21 | 23 | 24 | 25 | 26 | 27 | 28 | 29 | 30 | 31 | 32 | 33 | 34 | 35 | 36 | 37 | 38 | 39 | 40 | 41 | 41 | 42 | 43 | 44 | 45 | 46 | 47 | 48 | 49 | 50 | 51 | 52 |
| 29 | 19 | 20 | 22 | 23 | 24 | 25 | 26 | 27 | 28 | 29 | 30 | 31 | 32 | 33 | 34 | 34 | 35 | 36 | 37 | 38 | 39 | 40 | 41 | 42 | 43 | 44 | 45 | 46 | 47 | 47 | 48 | 49 | 50 |
| 30 | 18 | 20 | 22 | 23 | 23 | 24 | 25 | 26 | 27 | 28 | 29 | 30 | 31 | 32 | 32 | 33 | 34 | 35 | 36 | 37 | 38 | 39 | 40 | 41 | 41 | 42 | 43 | 44 | 45 | 46 | 47 | 48 | 49 |
| 31 | 17 | 19 | 21 | 22 | 23 | 24 | 24 | 25 | 26 | 27 | 28 | 29 | 30 | 30 | 31 | 32 | 33 | 34 | 35 | 36 | 37 | 37 | 38 | 39 | 40 | 41 | 42 | 43 | 44 | 44 | 45 | 46 | 47 |
| 32 | 17 | 19 | 20 | 21 | 22 | 23 | 24 | 24 | 25 | 26 | 27 | 28 | 29 | 30 | 30 | 31 | 32 | 33 | 34 | 35 | 35 | 36 | 37 | 38 | 39 | 40 | 41 | 41 | 42 | 43 | 44 | 45 | 46 |
| 33 | 16 | 18 | 20 | 20 | 21 | 22 | 23 | 24 | 25 | 25 | 26 | 27 | 28 | 29 | 29 | 30 | 31 | 32 | 33 | 34 | 34 | 35 | 36 | 37 | 38 | 38 | 39 | 40 | 41 | 42 | 43 | 43 | 44 |
| 34 | 16 | 17 | 19 | 20 | 21 | 21 | 22 | 23 | 24 | 25 | 25 | 26 | 27 | 28 | 29 | 29 | 30 | 31 | 32 | 33 | 33 | 34 | 35 | 36 | 37 | 37 | 38 | 39 | 40 | 41 | 41 | 42 | 43 |

Numbers shown are in "gear inches," the normal American and English way of calculating gears. By looking at the numbers, you can tell whether a 44 x 23 or a 36 x 19 is the bigger gear, and so forth. Formula: rear cog/front cog x nominal wheel diameter (26 or 27). The distance traveled method takes into account actual wheel diameter, and that's a smarter way to go...but it's sort of like Esperanto in that regard. For comparing one combination to another, this works fine.

GEAR CHART 26" WHEEL

CHAINRING

REAR COG

| | 20 | 22 | 24 | 25 | 26 | 27 | 28 | 29 | 30 | 31 | 32 | 33 | 34 | 35 | 36 | 37 | 38 | 39 | 40 | 41 | 42 | 43 | 44 | 45 | 46 | 47 | 48 | 49 | 50 | 51 | 52 | 53 | 54 |
|----|----|----|----|----|----|----|----|----|----|----|----|----|----|----|----|----|----|----|----|----|----|-----|-----|-----|-----|-----|-----|-----|-----|-----|-----|-----|-----|
| 11 | 47 | 52 | 57 | 59 | 61 | 64 | 66 | 69 | 71 | 73 | 76 | 78 | 80 | 83 | 85 | 87 | 90 | 92 | 95 | 97 | 99 | 102 | 104 | 106 | 109 | 111 | 113 | 116 | 118 | 121 | 123 | 125 | 128 |
| 12 | 43 | 48 | 52 | 54 | 56 | 59 | 61 | 63 | 65 | 67 | 69 | 72 | 74 | 76 | 78 | 80 | 82 | 85 | 87 | 89 | 91 | 93 | 95 | 98 | 100 | 102 | 104 | 106 | 108 | 111 | 113 | 115 | 117 |
| 13 | 40 | 44 | 48 | 50 | 52 | 54 | 56 | 58 | 60 | 62 | 64 | 66 | 68 | 70 | 72 | 74 | 76 | 78 | 80 | 82 | 84 | 86 | 88 | 90 | 92 | 94 | 96 | 98 | 100 | 102 | 104 | 106 | 108 |
| 14 | 37 | 41 | 45 | 46 | 48 | 50 | 52 | 54 | 56 | 58 | 59 | 61 | 63 | 65 | 67 | 69 | 71 | 72 | 74 | 76 | 78 | 80 | 82 | 84 | 85 | 87 | 89 | 91 | 93 | 95 | 97 | 98 | 100 |
| 15 | 35 | 38 | 42 | 43 | 45 | 47 | 49 | 50 | 52 | 54 | 55 | 57 | 59 | 61 | 62 | 64 | 66 | 68 | 69 | 71 | 73 | 75 | 76 | 78 | 80 | 81 | 83 | 85 | 87 | 88 | 90 | 92 | 94 |
| 16 | 33 | 36 | 39 | 41 | 42 | 44 | 46 | 47 | 49 | 50 | 52 | 54 | 55 | 57 | 59 | 60 | 62 | 63 | 65 | 67 | 68 | 70 | 72 | 73 | 75 | 76 | 78 | 80 | 81 | 83 | 85 | 86 | 88 |
| 17 | 31 | 34 | 37 | 38 | 40 | 41 | 43 | 44 | 46 | 47 | 49 | 50 | 52 | 54 | 55 | 57 | 58 | 60 | 61 | 63 | 64 | 66 | 67 | 69 | 70 | 72 | 73 | 75 | 76 | 78 | 80 | 81 | 83 |
| 18 | 29 | 32 | 35 | 36 | 38 | 39 | 40 | 42 | 43 | 45 | 46 | 48 | 49 | 51 | 52 | 53 | 55 | 56 | 58 | 59 | 61 | 62 | 64 | 65 | 66 | 68 | 69 | 71 | 72 | 74 | 75 | 77 | 78 |
| 19 | 27 | 30 | 33 | 34 | 36 | 37 | 38 | 40 | 41 | 42 | 44 | 45 | 47 | 48 | 49 | 51 | 52 | 53 | 55 | 56 | 57 | 59 | 60 | 62 | 63 | 64 | 66 | 67 | 68 | 70 | 71 | 73 | 74 |
| 20 | 26 | 29 | 31 | 33 | 34 | 35 | 36 | 38 | 39 | 40 | 42 | 43 | 44 | 46 | 47 | 48 | 49 | 51 | 52 | 53 | 55 | 56 | 57 | 59 | 60 | 61 | 62 | 64 | 65 | 66 | 68 | 69 | 70 |
| 21 | 25 | 27 | 30 | 31 | 32 | 33 | 35 | 36 | 37 | 38 | 40 | 41 | 42 | 43 | 45 | 46 | 47 | 48 | 50 | 51 | 52 | 53 | 54 | 56 | 57 | 58 | 59 | 61 | 62 | 63 | 64 | 66 | 67 |
| 22 | 24 | 26 | 28 | 30 | 31 | 32 | 33 | 34 | 35 | 37 | 38 | 39 | 40 | 41 | 43 | 44 | 45 | 46 | 47 | 48 | 50 | 51 | 52 | 53 | 54 | 56 | 57 | 58 | 59 | 60 | 61 | 63 | 64 |
| 23 | 23 | 25 | 27 | 28 | 29 | 31 | 32 | 33 | 34 | 35 | 36 | 37 | 38 | 40 | 41 | 42 | 43 | 44 | 45 | 46 | 47 | 49 | 50 | 51 | 52 | 53 | 54 | 55 | 57 | 58 | 59 | 60 | 61 |
| 24 | 22 | 24 | 26 | 27 | 28 | 29 | 30 | 31 | 33 | 34 | 35 | 36 | 37 | 38 | 39 | 40 | 41 | 42 | 43 | 44 | 46 | 47 | 48 | 49 | 50 | 51 | 52 | 53 | 54 | 55 | 56 | 57 | 59 |
| 25 | 21 | 23 | 25 | 26 | 27 | 28 | 29 | 30 | 31 | 32 | 33 | 34 | 35 | 36 | 37 | 38 | 40 | 41 | 42 | 43 | 44 | 45 | 46 | 47 | 48 | 49 | 50 | 51 | 52 | 53 | 54 | 55 | 56 |
| 26 | 20 | 22 | 24 | 25 | 26 | 27 | 28 | 29 | 30 | 31 | 32 | 33 | 34 | 35 | 36 | 37 | 38 | 39 | 40 | 41 | 42 | 43 | 44 | 45 | 46 | 47 | 48 | 49 | 50 | 51 | 52 | 53 | 54 |
| 27 | 19 | 21 | 23 | 24 | 25 | 26 | 27 | 28 | 29 | 30 | 31 | 32 | 33 | 34 | 35 | 36 | 37 | 38 | 39 | 39 | 40 | 41 | 42 | 43 | 44 | 45 | 46 | 47 | 48 | 49 | 50 | 51 | 52 |
| 28 | 19 | 20 | 22 | 23 | 24 | 25 | 26 | 27 | 28 | 29 | 30 | 31 | 32 | 33 | 33 | 34 | 35 | 36 | 37 | 38 | 39 | 40 | 41 | 42 | 43 | 44 | 45 | 46 | 46 | 47 | 48 | 49 | 50 |
| 29 | 18 | 20 | 22 | 22 | 23 | 24 | 25 | 26 | 27 | 28 | 29 | 30 | 30 | 31 | 32 | 33 | 34 | 35 | 36 | 37 | 38 | 39 | 39 | 40 | 41 | 42 | 43 | 44 | 45 | 46 | 47 | 48 | 48 |
| 30 | 17 | 19 | 21 | 22 | 23 | 23 | 24 | 25 | 26 | 27 | 28 | 29 | 29 | 30 | 31 | 32 | 33 | 34 | 35 | 36 | 36 | 37 | 38 | 39 | 40 | 41 | 42 | 42 | 43 | 44 | 45 | 46 | 47 |
| 31 | 17 | 18 | 20 | 21 | 22 | 23 | 23 | 24 | 25 | 26 | 27 | 28 | 29 | 29 | 30 | 31 | 32 | 33 | 34 | 34 | 35 | 36 | 37 | 38 | 39 | 39 | 40 | 41 | 42 | 43 | 44 | 44 | 45 |
| 32 | 16 | 18 | 20 | 20 | 21 | 22 | 23 | 24 | 24 | 25 | 26 | 27 | 28 | 28 | 29 | 30 | 31 | 32 | 33 | 33 | 34 | 35 | 36 | 37 | 37 | 38 | 39 | 40 | 41 | 41 | 42 | 43 | 44 |
| 33 | 16 | 17 | 19 | 20 | 20 | 21 | 22 | 23 | 24 | 24 | 25 | 26 | 27 | 28 | 28 | 29 | 30 | 31 | 32 | 32 | 33 | 34 | 35 | 35 | 36 | 37 | 38 | 39 | 39 | 40 | 41 | 42 | 43 |
| 34 | 15 | 17 | 18 | 19 | 20 | 21 | 21 | 22 | 23 | 24 | 24 | 25 | 26 | 27 | 28 | 28 | 29 | 30 | 31 | 31 | 32 | 33 | 34 | 34 | 35 | 36 | 37 | 37 | 38 | 39 | 40 | 41 | 41 |

Numbers shown are in "gear inches," the normal American and English way of calculating gears. By looking at the numbers, you can tell whether a 44 x 23 or a 36 x 19 is the bigger gear, and so forth. Formula: rear cog/front cog x nominal wheel diameter (26 or 27). The distance traveled method takes into account actual wheel diameter, and that's a smarter way to go...but it's sort of like Esperanto in that regard. For comparing one combination to another, this works fine.

Rivendell's Hours & Visiting Tips

HOURS

Monday through Friday, 9:10 am to 6:10 pm Pacific time. Although two days a week, usually Tuesday and Friday, we ride until 10:35. We'll try to work out a rotation, so that everyday someone's here by 9:15 a.m.



WILL CALLS

If you're in the area and need to will call something, phone it in first so we can have it ready for you. Also, you don't get to look over our shoulders as we punch in your order. It makes us make mistakes!

We'd like to be open Saturdays, but nobody here wants to work then. Maybe we'll find someone who can enter orders and take phone messages on Saturdays.

VISITING TIPS....AND RULES!

We aren't a normal retailer, and we don't have a browsing area, a shopping area, or the peoplepower to wait on you. Yet we're flattered that you'd like to come by and see us or our stuff. But we have to attend to our daily work of answering the phones, entering orders, servicing our customers on the phone, and so forth. Still, we're glad you want to see us. On the other hand, it tears us in many directions and often costs us an hour or two of work. But you know what? We *want* you to feel comfortable. If you can deal with all that, and can forgive us for not doting on you, and promise not to interpret our attending to business as rudeness, then by all means call first, and come on by. If you're here to see the frames and there's a snowball's chance that you'll order one, please say so.

WHAT TO EXPECT

We have around 1300 square feet, including small show room with a few frames, a small workshop, and an upstairs warehouse/work area, which is where we spend most of our time. It's convenient and affordable, but it's frumpy enough that we'd prefer you didn't take photos and put them on the web.

SIZINGS AND FITTINGS

If you want to be sized and fitted for a frame, schedule it a week in advance. Bring your cycling shoes, and if you're riding clip-less, bring your pedals, too. Sessions last an hour at least, and for that we charge \$150. BUT: If you then order a frame within a month, you may apply all of it toward your purchase.

TO FIND US

From the south or west: Take 680 N to the North Main exit. Set the odometer to zero. Turn right/north onto North Main for .33 miles, then left (at Cruchon's restaurant) onto Third Ave. for 0.1 mile. Just past the Ryder truck rental place, turn left into the Walnut Creek Business Center. We're around the corner, facing Walnut Creek Printing, next to Flathead Jack. Look for the brown door by the brown fence, and the 1561-B sign. Open the door, walk upstairs.

From the north: Take 680 S to the Oak Park exit. Left onto Main for about half a mile, the right onto Third for a tenth of a mile, then left into the Walnut Creek Business Center. Turn right, look for Flathead, hands off his car, and we're next to him. If his car is out, hands off it!

RIVENDELL ORDER FORM

NAME _____ ORDER DATE _____

ADDRESS _____

CITY _____ STATE _____ ZIP _____

SHIP TO, IF DIFFERENT _____

WORK PHONE: () _____ HOME. PHONE () _____

FAX: () _____ EMAIL: _____

| ITEM# | DESCRIPTION | QTY. | SIZE | EACH | TOTAL |
|-------|-------------|------|------|------|-------|
| | | | | | |
| | | | | | |
| | | | | | |
| | | | | | |
| | | | | | |
| | | | | | |
| | | | | | |
| | | | | | |
| | | | | | |
| | | | | | |
| | | | | | |
| | | | | | |
| | | | | | |
| | | | | | |
| | | | | | |
| | | | | | |
| | | | | | |
| | | | | | |
| | | | | | |
| | | | | | |
| | | | | | |
| | | | | | |
| | | | | | |

BACK ISSUES/RR, \$2 EA: 2, 3, 4, 5, 7, 8, 10,11,12,13, 14, 15 (CIRCLE CHOICES)

| SHIPPING | | |
|----------|--------|------|
| | Ground | Air |
| UPS | \$5 | \$12 |
| CANADA | \$15 | \$22 |
| INT'L | \$25 | \$45 |

| | |
|--|--|
| First Subtotal: | |
| Minus any Rivendollars or Gift Cert: | |
| Second, possibly lower subtotal: | |
| Tax (CA only): | |
| Shipping (see left): | |
| Membership or subscription renewal (\$15) | |
| 99-Year Membership/Subscription (\$200) | |
| TOTAL: | |

PAYMENT

Check or money order number: _____ Amount: _____

Credit Card #: _____ EXPIRES (month/year) _____ / _____

ATTENTION NEW MEMBERS!

If you are joining now and already have the catalogue , please put an X here ____.

If you already have a sample copy of the RR, tell us which issue it is (14? 15?) and we'll start your subscription with the next one. I have _____. Thanks.

Meet the Staff



ALLEN ESCOBAR

FAVORITE FOOD: Potato salad

FAVORITE BOOK (fiction): I don't read fiction.

FAVORITE BOOK (non-fiction): "The Rise of Theodore Roosevelt"

THREE FAVORITE MOVIES: Last of the Mohicans, Hunt for Red October, A Few Good Men

IDEAL BIKE RIDE: One day road ride, sunny but cool with a light breeze, hilly with lots of switchbacks, two lane road with no traffic and lots of Redwood trees lining the road.

FAVORITE NON-CYCLING ACTIVITIES: Off-road driving and camping

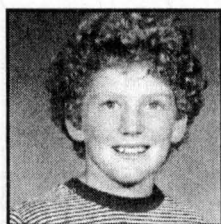

PETER KELLEY

FAVORITE FOOD: Mexican (Super Burrito)

FAVORITE BOOK (fiction): Bonfire of the Varieties

FAVORITE BOOK (non-fiction): Accidental Empires

THREE FAVORITE MOVIES: Hunt For Red October, A Few Good Men, Fletch

IDEAL BIKE RIDE: On and around Mount Tamalpais

FAVORITE NON-CYCLING ACTIVITY: Snow skiing, hiking/camping, water skiing.

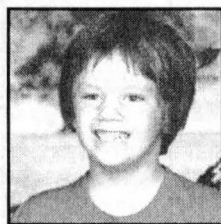

JOE BAUDER

FAVORITE FOOD: Mission-style burrito (w/sour cream, black beans)

FAVORITE BOOK (fiction): Left Out In The Sun (Gary Snyder)

FAVORITE BOOK (non-fiction): 13th Gen Abort. Retry, Ignore, Fail

THREE FAVORITE MOVIES: The Shawshank Redemption, True Stories, anything by the Cohen brothers (Raising Arizona)

IDEAL BIKE RIDE: Any commute, as long as I'm not in a hurry

FAVORITE NON-CYCLING ACTIVITY: Going out with friends

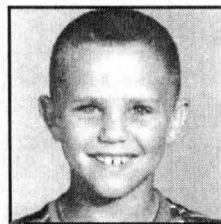

GRANT PETERSEN

FAVORITE FOOD: Figs, apricots, cereal.

FAVORITE BOOK (fiction): Tolkien's trilogy

FAVORITE BOOK (non-fiction): The Survival of the Bark Canoe (John McPhee)

THREE FAVORITE MOVIES: The Sound of Music, The Wizard of Oz, The Fugitive

IDEAL BIKE RIDE: 2-3 day lightly loaded hilly on/off road tour with stores around so I don't have to carry too much food.

FAVORITE NON-CYCLING ACTIVITIES: Trout fishing, playing with my children in the trees in our back yard, playing catch and hitting hard-balls with wood bats.

RIVENDELL ORDER FORM

NAME _____ ORDER DATE _____

ADDRESS _____

CITY _____ STATE _____ ZIP _____

SHIP TO, IF DIFFERENT _____

WORK PHONE: () _____ HOME. PHONE () _____

FAX: () _____ EMAIL: _____

| ITEM# | DESCRIPTION | QTY. | SIZE | EACH | TOTAL |
|-------|-------------|------|------|------|-------|
| | | | | | |
| | | | | | |
| | | | | | |
| | | | | | |
| | | | | | |
| | | | | | |
| | | | | | |
| | | | | | |
| | | | | | |
| | | | | | |
| | | | | | |
| | | | | | |
| | | | | | |
| | | | | | |
| | | | | | |
| | | | | | |
| | | | | | |

BACK ISSUES/RR, \$2 EA: 2, 3, 4, 5, 7, 8, 10, 11, 12, 13, 14, 15 (CIRCLE CHOICES)

| SHIPPING | | |
|----------|--------|------|
| | Ground | Air |
| UPS | \$5 | \$12 |
| CANADA | \$15 | \$22 |
| INT'L | \$25 | \$45 |

| | | |
|--|--------------------------------------|--|
| | First Subtotal: | |
| | Minus any Rivendollars or Gift Cert: | |
| | Second, possibly lower subtotal: | |
| | Tax (CA only): | |
| | Shipping (see left): | |
| Membership or subscription renewal (\$15) | | |
| 99-Year Membership/Subscription (\$200) | | |
| | TOTAL: | |

PAYMENT

Check or money order number: _____ Amount: _____

Credit Card #: _____ EXPIRES (month/year) _____ / _____

ATTENTION NEW MEMBERS!

If you are joining now and already have the catalogue, please put an X here _____.

If you already have a sample copy of the RR, tell us which issue it is (14? 15?) and we'll start your subscription with the next one. I have _____. Thanks.

RIVENDOLLARS

AS USUAL, RESTRICTIONS APPLY.
NOT GOOD TOWARD FRAMES



TEN

RIVENDOLLARS

FIRST TIME BUYERS ONLY

MINIMUM \$50 PURCHASE

Good Through December 31, 2002

Members only, not combinable with other coupons.

TEN

RIVENDOLLARS

MINIMUM \$150 PURCHASE

Good Through December 31, 2002

Members only, not combinable with other coupons.

SEVEN

RIVENDOLLARS

MINIMUM \$80 PURCHASE

Good Through December 31, 2002

Members only, not combinable with other coupons.

FIVE

RIVENDOLLARS

MINIMUM \$30 PURCHASE

Good Through December 31, 2002

Members only, not combinable with other coupons.

Notes



FRONT COVER PHOTO: JACK VOSNEY — BACK COVER PHOTO: SPENCER CHAN
BUILDER PHOTOS: BOB SCHENKER
DESIGN & LAYOUT: CRAIG DAWSON, MEDIA SOLUTIONS, SAN FRANCISCO
COPYRIGHT © 1999 RIVENDELL BICYCLE WORKS



www.rivendellbicycles.com

RIVENDELL BICYCLE WORKS
1561-B THIRD AVENUE
WALNUT CREEK, CA 94596

BULK RATE
US POSTAGE
PAID
WALNUT CREEK
CALIFORNIA
PERMIT#816

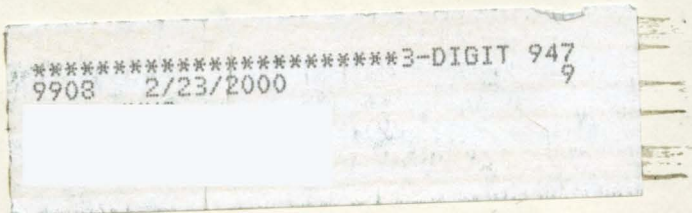

FOUR DOLLARS