

1998



Technology and emotion

Campagnolo

Technology and emotion

From the very beginning Campagnolo, a company that grew out of a symbiosis with the greatest athletes in cycling history, from Coppi and Bartali up to Indurain and Ullrich, always pursued the primary goal of designing and offering reliable bicycle components to the market by immediately responding to the demanding requirements of the world's leading bicycle racers. Consequently all of Campagnolo's products are designed and manufactured for extreme riding conditions, at the same time representing the ideal solution for any kind of cycling enthusiast, whether for the professional bicycle racer or the non-competitive recreational rider. In recent years our efforts in product development have been intense - one need only think of Campagnolo's integrated Ergopower controls, Dual-Pivot brakes, Exa-Drive chainrings and freewheel cassettes, as well as the new 9-speed transmission and a complete range of high-profile rims, which have all revolutionized the standards of modern bicycle technology. All these innovations have been developed with the utmost care, so as to offer products featuring faultless performance and functionality, utilizing designs and materials resulting in the lowest possible weight without ever compromising aspects, such as safety, comfort, elegance and durability, the traditional hallmarks of every Campagnolo product.





groups

CAMPAGNOLO

- 6 New for 1998
- 12 Record
- 18 Chorus
- 22 Athena
- 28 Veloce
- 32 Mirage
- 34 Avanti
- 36 Record track
- 37 Triathlon Components



rims

CAMPAGNOLO



- 53 Range 1998
- 54 Road Rims

INDEX

wheels CAMPAGNOLO



FLUID-DYNAMIC

- 38 Bora Titanium
- 40 Shamal Titanium
- 42 Vento 16-HPW
- 43 Zonda 16-HPW
- 44 Scirocco 20
- 45 Eurus 20
- 46 Ghibli

CLIMB-DYNAMIC

- 48 New for 1998
- 50 Electron
- 52 Proton



groups

CAMPAGNOLO



9 SPEED for Athena and Veloce

The 9-speed system introduced in 1997 on the top-of-the-line Record and Chorus groupsets is now offered with Athena and Veloce as well. Thus the new standard equipment of the latter two mid-range groupsets will include an ultra-light drivetrain, featuring perfect shifting operation and a wide range of gearing options, so as to respond to the demands of all categories of riders, from the amateur cyclist to the competitive bicycle racer. The same 9-speed drivetrain took Bjarne Riis to victory in the 1996 Tour de France! Barely a year after its introduction this system is already made available for the assembly of top-class racing bicycles at a truly affordable price.



Campagnolo has always promoted the use of triple chainrings. These days, especially given the growing popularity of so-called century rides (long distances with a series of tough climbs), there is a rising demand for triple-sets as more and more cyclists wish to participate in these ambitious events. In order to offer a drivetrain with the greatest number of

gearing options possible, including all the latest technical refinements, in its 1998 range Campagnolo has introduced a 3x9-Speed system, specifically designed to work with triple cranksets. This novelty obviously required changes in the Racing Triple and Veloce Triple rear derailleurs as well as up-grading the Veloce Triple crankset to 9-speed specifications and adopting all the remaining essential 9-speed components: Ergopower, chain, rear hub and, of course, a 9-speed cassette. The new Racing Triple rear derailleur, which is offered for Campagnolo's high-end Record, Chorus and Athena 9-Speed triple sets, has been totally redesigned. The 9-Speed Racing T derailleur has a different parallelogram (made of cold-forged aluminum) providing an increased travel to cover the greater width of the 9-speed cassette. Regarding the Veloce groupset, introducing the 3x9 speed transmission has required a special rear derailleur to be combined with the triple chainring crankset.

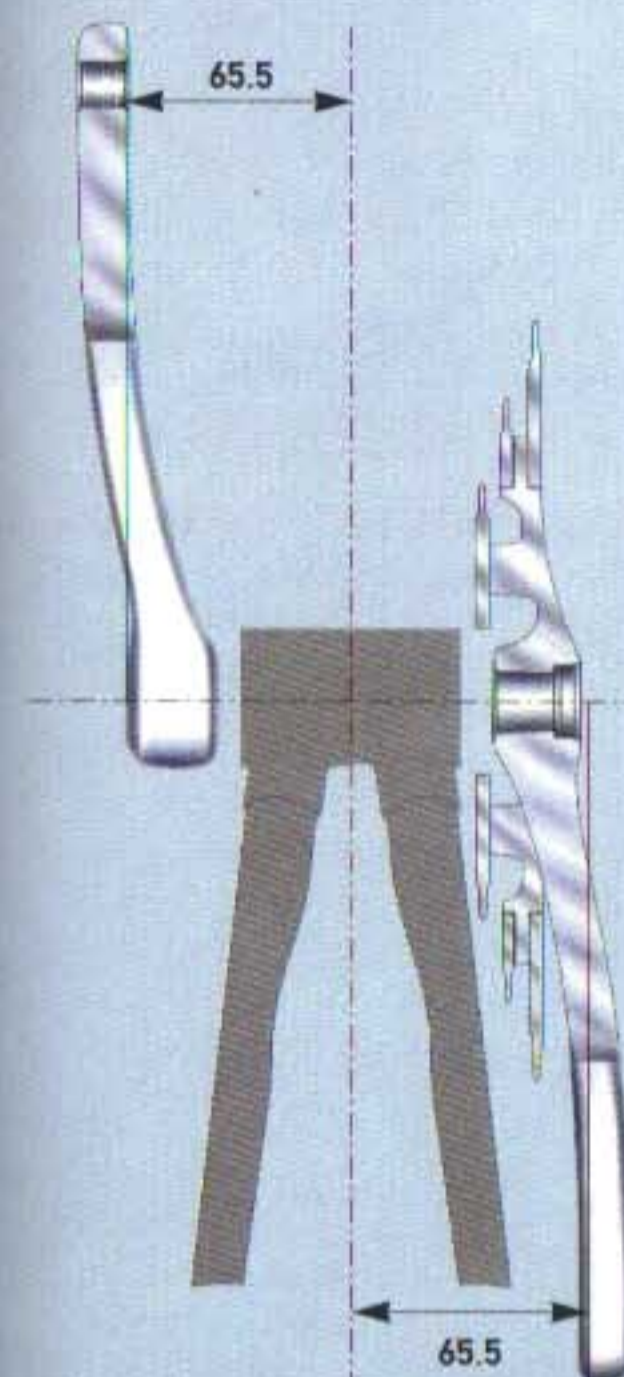

new design of LEFT HAND CRANK on all triple cranksets

In the spirit of offering a product fashioned with the maximum attention to detail regarding both performance and comfort, Campagnolo has redesigned the left hand crank on all triple cranksets, in order to achieve perfect symmetry between the right and left hand crank. Thanks to the new crank design, anyone using a triple crankset will now adopt a totally balanced and comfortable pedaling motion, as the distance between both pedals and the center of the frame will be the same.

further WEIGHT reduction

The search for maximum lightness obtained through a careful analysis of every detail, represents a continuous development. The general objective of light weight, however, is never attained by compromising any of Campagnolo's unique quality standards regarding safety, comfort and durability. Many of the 1998 components have been lightened-up both through the application of advanced materials such as titanium, 7075 aluminum alloy and carbon-fiber, as well as through the study of new designs and alternative profiles. The new Record and Chorus Ergopower controls and freewheel cassettes, the new Record seat-post, the new Pro-Fit pedals, the new Record and Athena headsets and the new Record and Veloce rear derailleurs are perfect examples for Campagnolo's approach in promoting a continuous product innovation.





groups

CAMPAGNOLO



SMOOTH and EFFORT-LESS control lever operation

Across the entire range improvements have been carried out on the Ergo-powers as well. All new right hand Ergopower controls now feature a much smoother action, due to the introduction of a new compensation spring corresponding to the use of a similar spring inserted into all the left-hand levers in 1997.

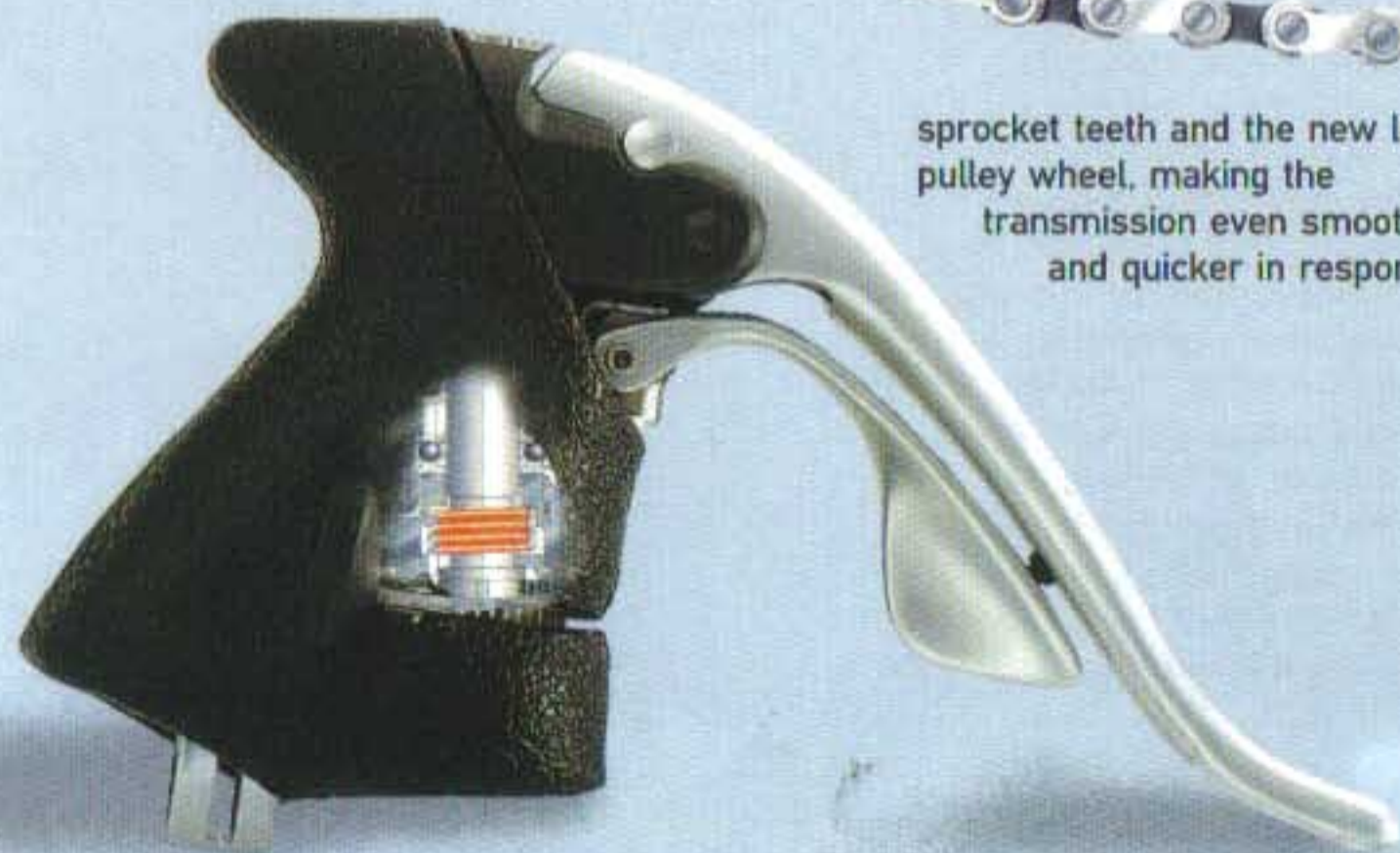

improved NOISE REDUCTION and performance standards

The new 9-speed drivetrains offer even more silent and smoother shifting operation. Thanks to the use of a new lower derailleur pulley, all new 9-speed rear derailleurs offer improved chain alignment, making the transmission



extremely silent in operation. All 9-speed chains are produced with special chamfers (Campagnolo's patented Floating Link Action) and allow perfect interaction between the Exa-Drive sprocket teeth and the new lower pulley wheel, making the transmission even smoother and quicker in response.

DUAL PIVOT brakes for the whole range

Campagnolo has always attributed the greatest importance to aspects of safety and comfort. Although more powerful than traditional caliper brakes, Dual-Pivot brakes provide a more controllable and progressive braking action. Furthermore, compared to traditional caliper brakes, Dual-Pivot brakes require substantially less effort in operation, while producing the same degree of deceleration. Given the advantages of these brakes Campagnolo

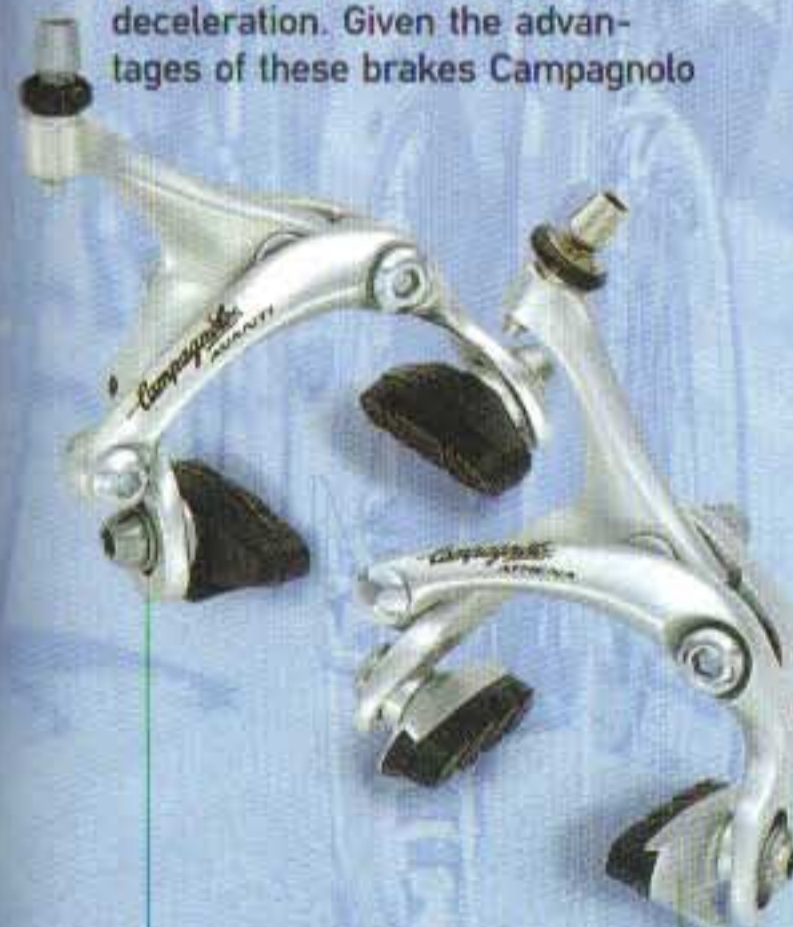

has decided to introduce them throughout the range, equipping the Veloce, Mirage and Avanti groupsets with Dual-Pivot brakes. Both brake arms are made of forged aluminum alloy, operating on miniature ball-bearings or bushings and an eccentric cam which multiplies the input force applied to the control lever during brake activation.

New Avanti brakes: Dual-Pivot brakes as standard equipment on Campagnolo's entry-level component group.



Record brakes: both pivot points contain self-lubricating bearings.

both pivot points contain self-lubricating bearings.

16 kg 24 Kg

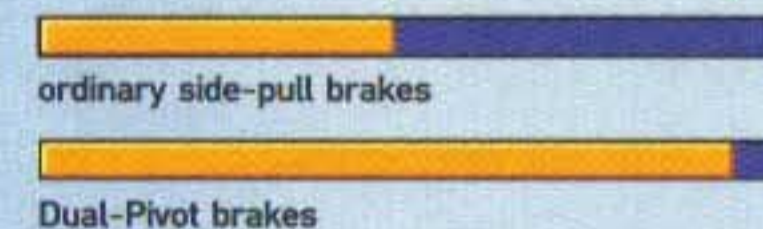

Braking power when applying a force equivalent to 20 kg with ordinary side-pull brakes and Dual-Pivot brakes.

Athena brakes: aluminum brake shoes featuring orbital adjustment.



groups

CAMPAGNOLO

- Release tension display.
- Inclined tabs.
- Interchangeable steel portion of cleat
- Axle featuring minimal play.
- Engaging and release spring.
- Aluminium body.



- Bolt for adjusting release tension.

- Minimal distance (10.5mm) between axle and pedal platform.



new PEDALS



1998 is the year of the new Pro-Fit pedals, designed and produced entirely by Campagnolo. A high-tech pedal concept featuring a meticulous and modern design through which aspects such as reliability, functionality and comfort are taken to unprecedented levels. Size and weight stand out as the most remarkable innovations of this new pedal design: Pro-Fit pedals are small, yet still allow the use of traditional-size cleats; they are extremely light (a pair of pedals totals 266 grams for the Record, 325 grams for the Chorus and 310 grams for the Athena version) and the cornering clearance is far superior to the system previously adopted. The ergonomics of pedaling have been carefully studied resulting in a pedal with four well-distributed pressure points, thus giving superb comfort even at the end of very long rides. The pedal height is significantly reduced placing the foot much closer to the pedal axle, thus facilitating a round pedaling action. Campagnolo pedal axles offer extremely tight manufacturing tolerances so as to guarantee minimum play, while providing unmatched durability. An interesting and highly innovative aspect of Pro-Fit pedals lies in the unique engaging mechanism: the force



required to engage the cleat in the pedal is minimal, remaining consistent regardless of the pre-selected setting of the release tension. Release tension can be varied and is easily selected by means of an adjustment Allen-socket positioned on the accessible side of the pedal body. The rear portion of the pedal contains a window displaying the pre-selected release tension. A further important feature of the Pro-Fit system are the customized cleats which have two slightly inclined tabs in order to avoid accidental disengagement from the pedal caused by unintentional lateral movements of the foot. The ergonomic resting position of the pedal has been designed to benefit an easy and instant engagement of the shoe. Cleats are available in two versions: fixed or with float and have a standard three-bolt mounting pattern, thus adapting to the majority of cycling shoes on the market. Campagnolo offers three different models of Pro-Fit pedals: Record, Chorus and Athena.

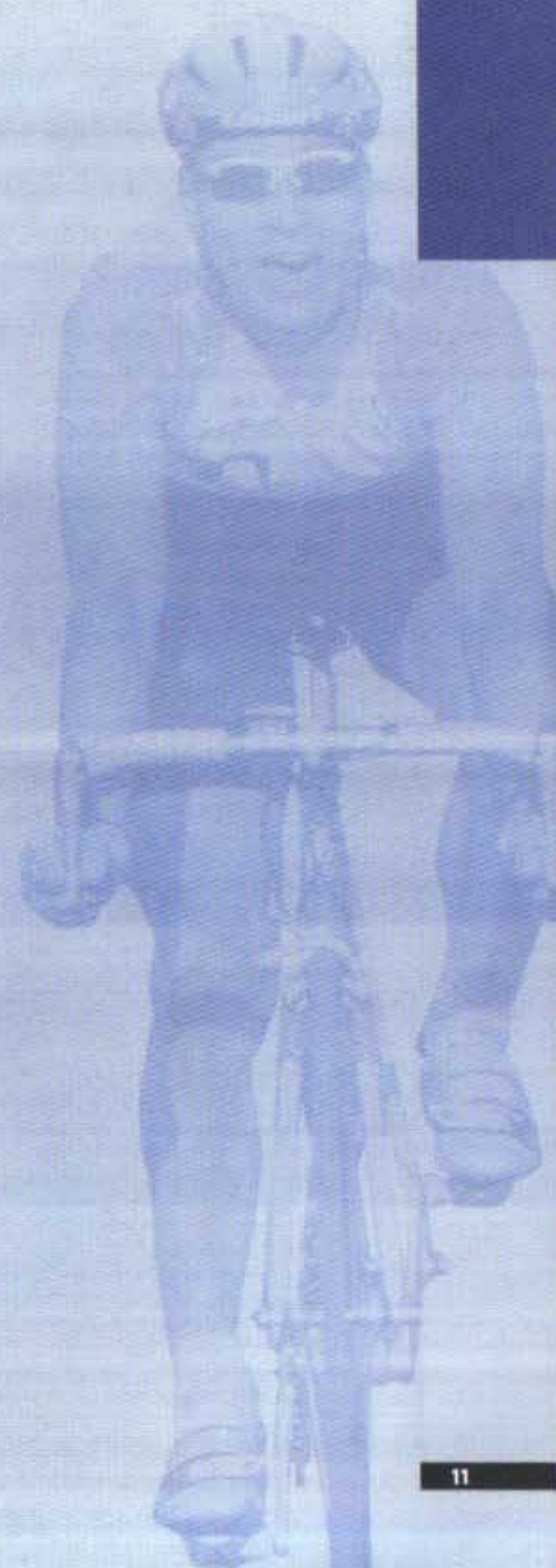



groups

CAMPAGNOLO

RECORD

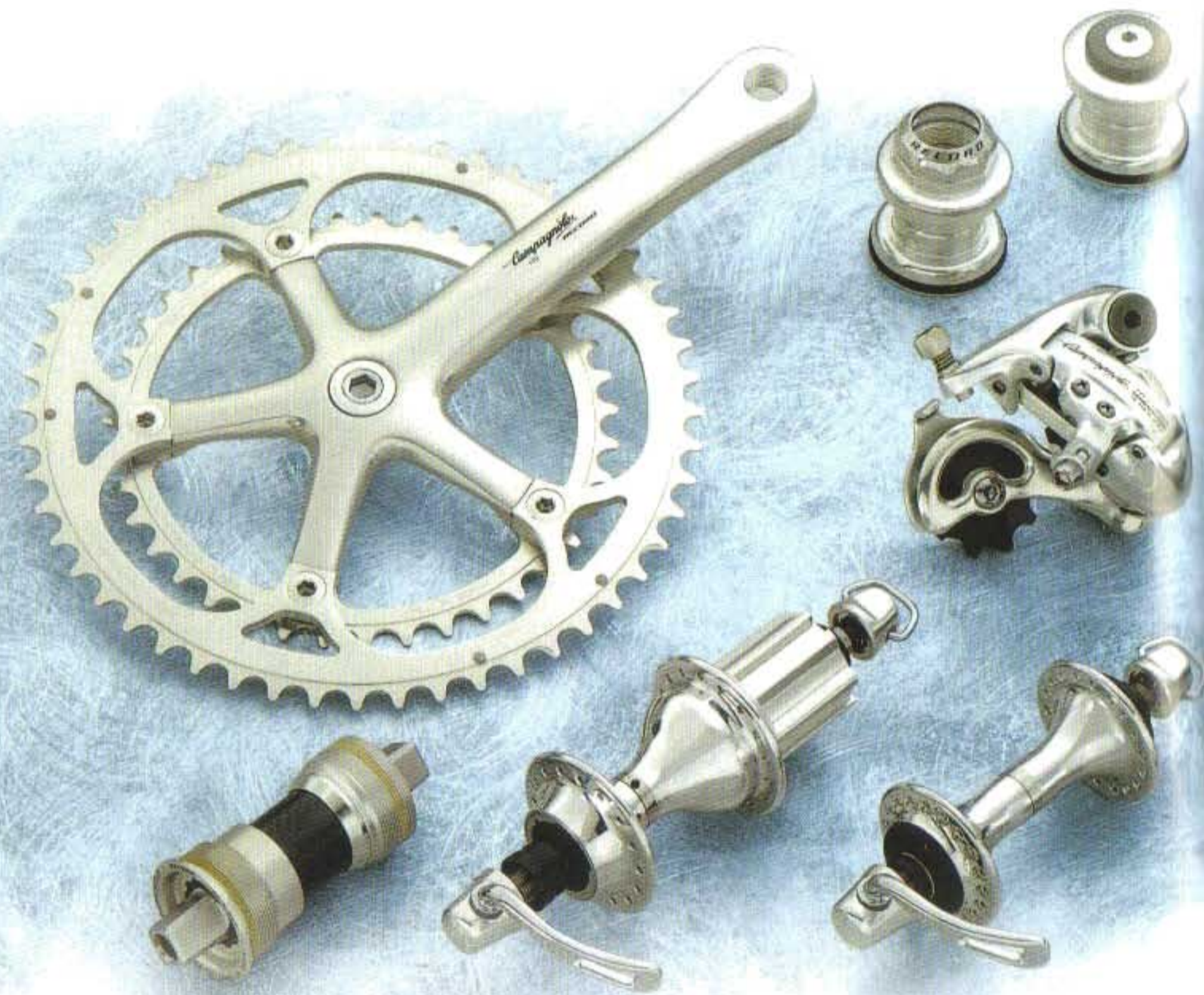

RECORD



groups

CAMPAGNOLO

NEW FOR RECORD



redesigned ERGOPOWER

The top-of-the-line Record groupset for 1998 has been completely redesigned receiving a series of important refinements. Starting with the new Ergopower, the new integrated Record brake/shift controls have received a more compact design with widely improved ergonomics and use a lighter lever for significantly smoother shifting operation. The reduction in size was made possible by lowering the Ergopower body by 2mm and shortening the distance from the brake lever to the handlebars by a total of 8mm (to the benefit of riders with small hands). As a result the new controls offer better grip, especially when reaching the brake lever from the top of the hoods. Furthermore an overall weight reduction of 35 grams could be achieved for the pair of levers. The greater smoothness in front

and rear derailleur shifting operation is the result of adopting a spiral compensation spring and one centimeter longer shifting levers. As with the previous models, the redesigned Record Ergopower offers a range of ergonomic gripping positions. The main pivot for the indexing mechanism is made of surface-hardened 7075 aluminum alloy (a material even lighter than titanium).

new rear DERAILLEUR

The Record rear derailleur ensures smoother and more silent rear derailleur shifting thanks to the use of a new lower pulley giving improved chain guidance. The new rear derailleur cable clamping plate is now made of aluminum, saving 4 grams and improving the overall aesthetics of the component.



New cable clamping bolt and plate.

New lower pulley.

new RECORD EXA-DRIVE MK2 cassettes

The new Record EXA-DRIVE MK2 cassettes are more rigid, providing easier and quicker assembly as well as further weight reductions (e.g. for a 13-23 cassette 13 grams in the case of a standard Record version and 6 grams for the optional titanium version). The new, patented MK2 cassettes are composed of two clusters of each two and three sprockets which are pre-assembled onto a particularly rigid 7075 aluminum carrier, and 4 individual sprockets. This arrangement offers weight reductions and easier cassette assembly. Standard Record cassettes come in six combinations, each featuring a larger cluster of titanium sprockets. The optional



All Exa-Drive MK2 cassettes are compatible with 1997 9-speed cassette hubs

new CASSETTE HUB

The Record freewheel body was redesigned according to the new 4-tooth engaging pattern of the MK2 sprockets. The new cassette hub is 3 grams lighter and fully compatible with all 1997 9-speed cassettes.



full titanium version is available in four combinations with a total of nine titanium sprockets.

RECORD



groups CAMPAGNOLO



new 9-speed CHAIN

The new Record 9-Speed chain (also part of the Chorus and Athena group-sets) has nickel-plated, instead of the previously burnished rollers, in order to provide extended chain-durability. The new chain is designed with special chamfers (the patented Floating Link Action) for perfect interaction with Exa-Drive sprockets and chainrings as well as with the new lower rear derailleur pulley, making the 9-Speed drivetrain even smoother and more silent.

new HEADSET

The new Record headset for unthreaded steerers is 10 grams lighter than the 1997 HS 100 model. This reduction was made possible by using a new 7075 adjusting bolt and a carbon-fiber cover plate. Furthermore, the

lower cup of the 1998 threadless headset carries a lubrication port enabling regular maintenance without having to disassemble the headset. Campagnolo's threadless headset models (a separate version is available for Chorus) are extremely easy to fit, thanks to the exclusive self-centering system of the upper bearing

races, very light in weight and feature a much reduced stacking height in the upper headset portion (only 12.5mm). The system also allows for a quicker and more precise adjustment, providing extremely smooth steering motion and longer durability than traditional headsets.



new SEATPOST

The Record seatpost has been completely renewed. In order to adapt to the popularity of more compact modern frame geometries, the new seatpost has been extended to an overall length of 250mm and at the same time the use of advanced materials actually makes the new model 29 grams lighter than the previous aluminum version. The seat clamps are slimmer and are connected to the head of the seatpost by interacting knurled surfaces offering a steadier grip than wedged seatpost connections. The cold forged-alloy head is press-fit in the seatpost shaft, which is made of a proprietary chrome-vanadium steel alloy tube. The use of this material makes the tube much thinner than the previous aluminum version. In order to maximize the weight reduction of this component, the tightening bolt has a 5mm rather than a 6mm Allen-socket and the washer is made of aluminum instead of steel.

Diagram comparing the weight of the new Pro-Fit Record pedals with the 1997 model.

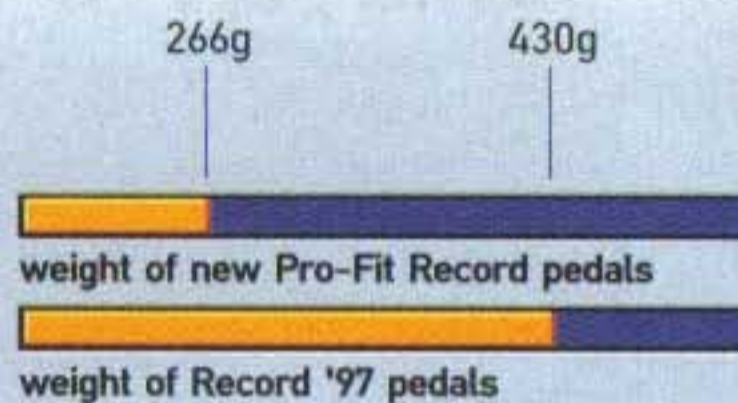

new PEDALS



Thanks to the use of titanium axles the Pro-Fit Record pedals are the lightest in the 1998 range. The overall weight of a pair of pedals has been reduced by 164 grams in comparison to last year's Record model. The common features of all



Campagnolo's Pro-Fit pedals are their compact size, the ample foot support, a consistent cleat engaging tension, regardless of the preselected release tension, a greater cornering clearance and the pedals compatibility with most every cycling shoe on the market.

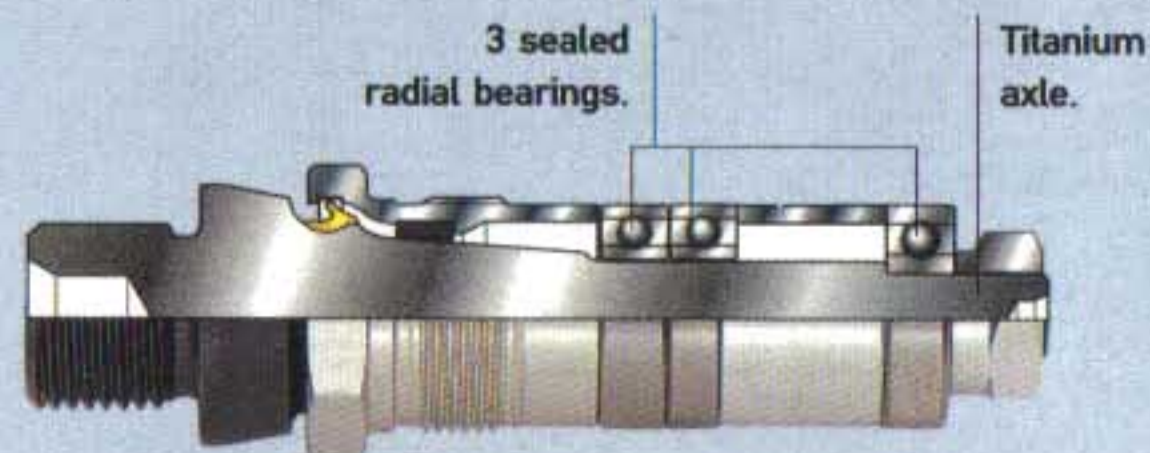



groups

CAMPAGNOLO

CHORUS



CHORUS

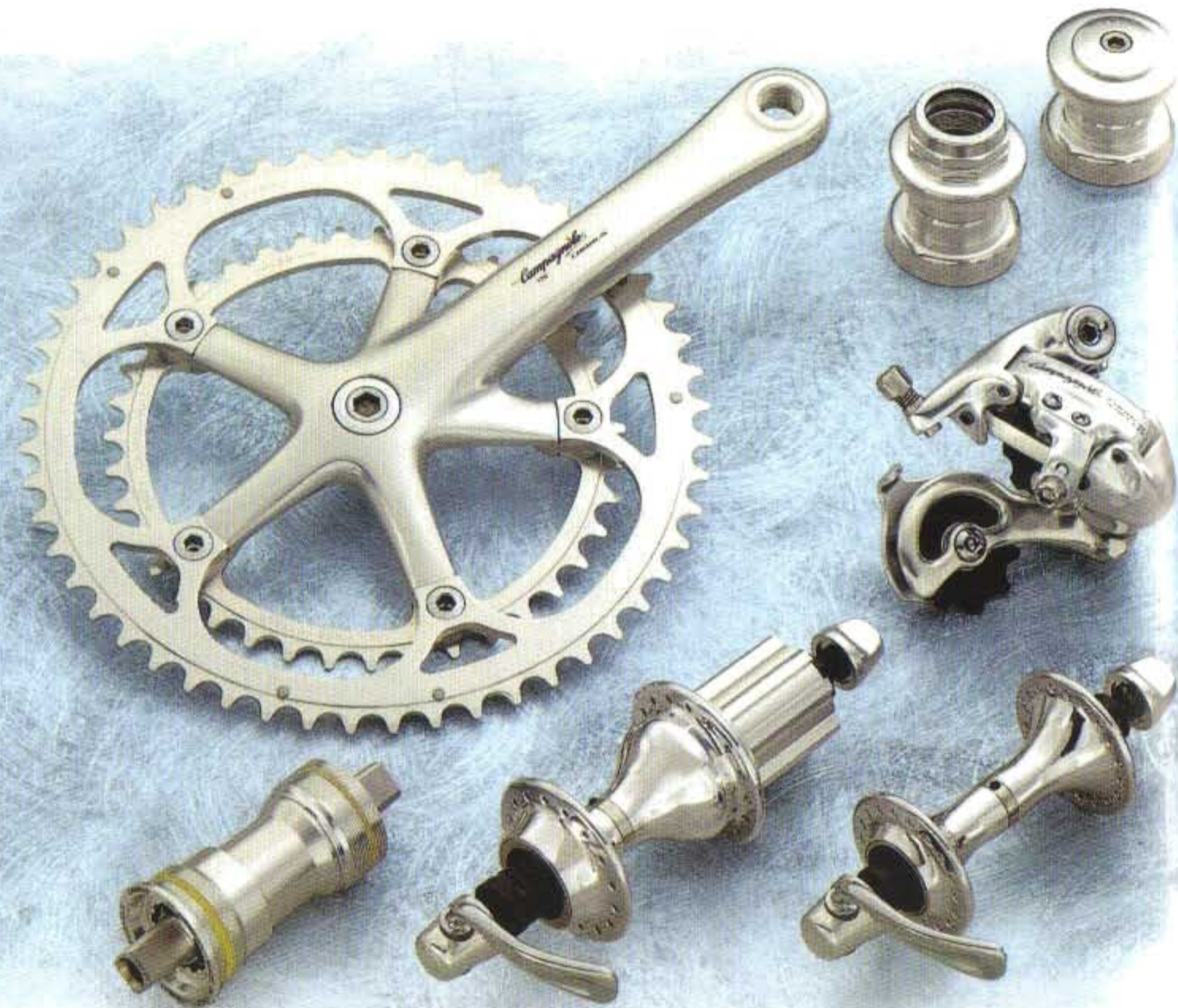



groups CAMPAGNOLO



redesigned ERGOPOWER

The new Chorus Ergopower has a similar design to the Record model. It differs from the top-of-the-line model for having the main pivot shaft of steel as opposed to 7075 aluminum. Furthermore, the shifting levers are not drilled out as the Record ones. The new integrated Chorus brake/shift controls have received a more compact design with widely improved ergonomics and also use a lighter lever for significantly smoother shifting operation. The reduction in size was made possible by lowering the Ergopower body by 2mm and shortening the distance from the brake lever to the handlebars by a total of 8mm (to the special benefit of riders with small hands). As a result the new controls offer better grip, especially when reaching the brake levers from the top of the hoods. Furthermore an overall weight reduction of 46 grams could be achieved on a pair of levers. The greater smoothness in front and rear derailleur shifting operation is the result of adopting a spiral compensation spring and one centimeter longer shifting levers. As with the previous models, the redesigned Chorus Ergopower offers a wide range of ergonomic gripping positions.

new REAR DERAILLEUR

Like all the new 9-speed rear derailleurs also the Chorus model is provided with a new lower pulley to ensure smoother and more silent rear derailleur shifting. More detailed innovations regard the use of a new drilled-out and therefore lighter derailleur mounting bolt and a new aluminum cable clamping plate which is lighter and aesthetically more pleasing. As in the Record version, the Chorus parallelogram is made up of cold forged parts.



New mounting bolt.

New cable clamping plate.

new lower pulley.



new CHORUS EXA-DRIVE MK2 cassettes

Easier fitting and superior weight reductions are delivered with the Chorus EXA-DRIVE MK2 cassettes. The new, patented MK2 cassettes are composed of two clusters of each two and three sprockets which are pre-assembled onto a particularly rigid 7075 Aluminum carrier, and 4 individual sprockets. This arrangement offers weight reductions and easier cassette assembly. Standard Chorus MK2 cassettes feature nine steel sprockets and come in four set combinations. The optional full titanium version is available in four combinations featuring a total of nine titanium sprockets. A special first position sprocket with only four internal spline-engaging teeth provides for additional weight savings. All Exa-Drive MK2 cassettes are compatible with 1997 9-speed cassette hubs. Chorus EXA-DRIVE MK2 cassettes are also part of the standard 9-Speed equipment of this year's Athena groupset and produce an average weight reduction of 30 grams.

new PEDALS PRO-FIT

The new Chorus Pro-Fit pedals are very light, with a compact and highly modern design. The pedal axles are made of steel with adjustable cup and cone bearings and inserted into aluminum fixing cartridges. The high tensile steel axles provide extreme rigidity for very efficient power transmission and high durability of the bearing races. The overall weight of the pedals has been reduced by 106 grams when compared to a pair of last year's Chorus models.

Aluminum fixing cartridge.



Steel axle.

Cone bearings with two sets of 11 1/8" bearings.

Adjustable cup.

new CASSETTE HUB

The Chorus freewheel body was redesigned to match the new 4-tooth engaging pattern of the MK2 sprockets. The new cassette hub is lighter and fully compatible with all 1997 9-speed cassettes.

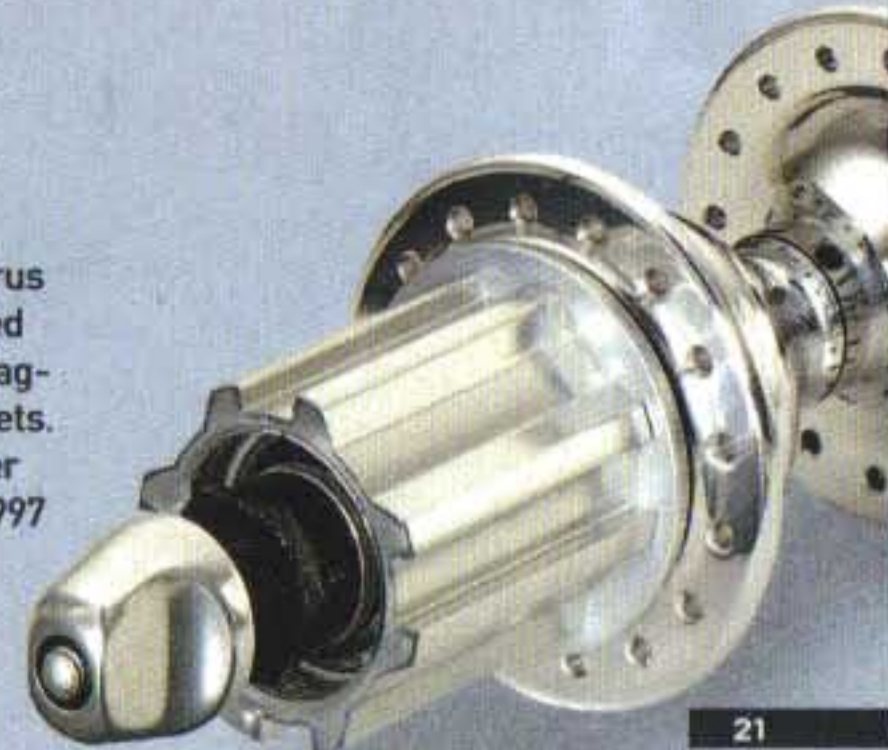
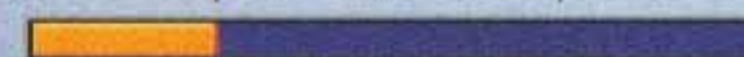

Diagram comparing pedal-axle flex under same applied load

0,43 mm

0,60 mm



flex of new Pro-Fit Chorus pedals

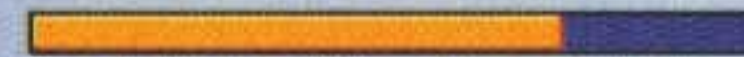

flex of other models on the market



groups

CAMPAGNOLO



ATHENA

ATHENA

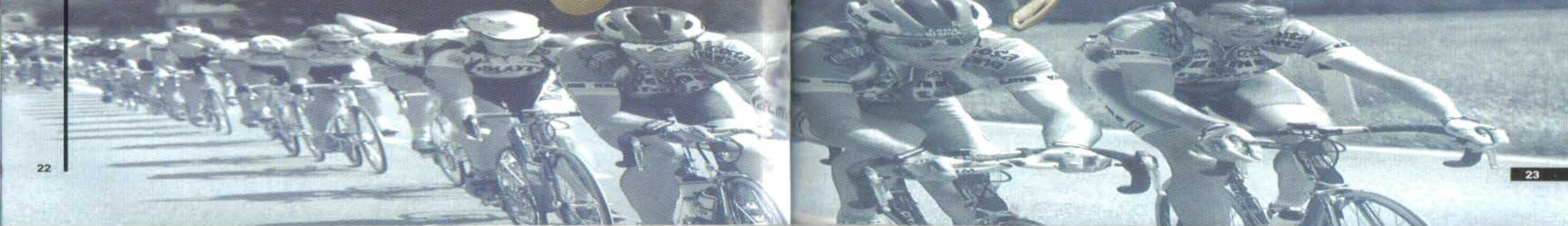



groups

CAMPAGNOLO



new ERGOPOWER 9 speed

The most important news for the new Athena groupset is the fact that it has become 9-Speed. Thus a new right hand 9-speed Ergopower is now part of the system with a special compensation spring for smooth and effortless shifting operation. The total weight of a pair of Athena Ergopower levers is only 430 grams.

New mounting bolt.

New recessed set screws.

New cable clamping bolt.

New lower pulley.



new 9-speed REAR DERAILLEUR

The new Athena group is equipped with a completely innovated rear derailleur. Many changes were introduced to make the derailleur compatible with the 9-Speed system, but also to raise the component to the standards of Campagnolo's high-end groupsets. The 9-Speed system mainly required the adoption of a rear derailleur parallelogram with a wider travel in order for it to adequately operate across all 9 sprockets. Also the derailleur cage plates and the pulleys needed to be narrowed to enable the use of the 9-speed chain. Visible differences refer to the new recessed setting screws and a new cable clamping bolt. Mainly for the sake of weight reductions and improved performance the following additional changes have been introduced: a narrower derailleur cage provides sufficient clearance between the inner cage-plate and the drive-train spokes, a new drilled out mounting bolt is adopted for lightness together with the new lower pulley giving improved chain guidance for smoother and more silent rear derailleur shifting. The plates of the parallelogram and the derailleur cage are made of aluminum.



new EXA-DRIVE MK2 cassettes for ATHENA too

The Athena groupset is equipped with the new Chorus EXA-DRIVE MK2 cassettes with steel sprockets.

new HEADSET

The 1998 Athena groupset comes with a new headset featuring a LOW STACKING HEIGHT design which results in a notable weight reduction (-35 grams) and a shorter stacking height (12.5 + 24 mm). Just as for the top-of-the-line component sets, the new Athena headset features differential ball-bearings with diagonally set bearing races to provide easy and precise adjustment, as well as high durability.





groups

CAMPAGNOLO

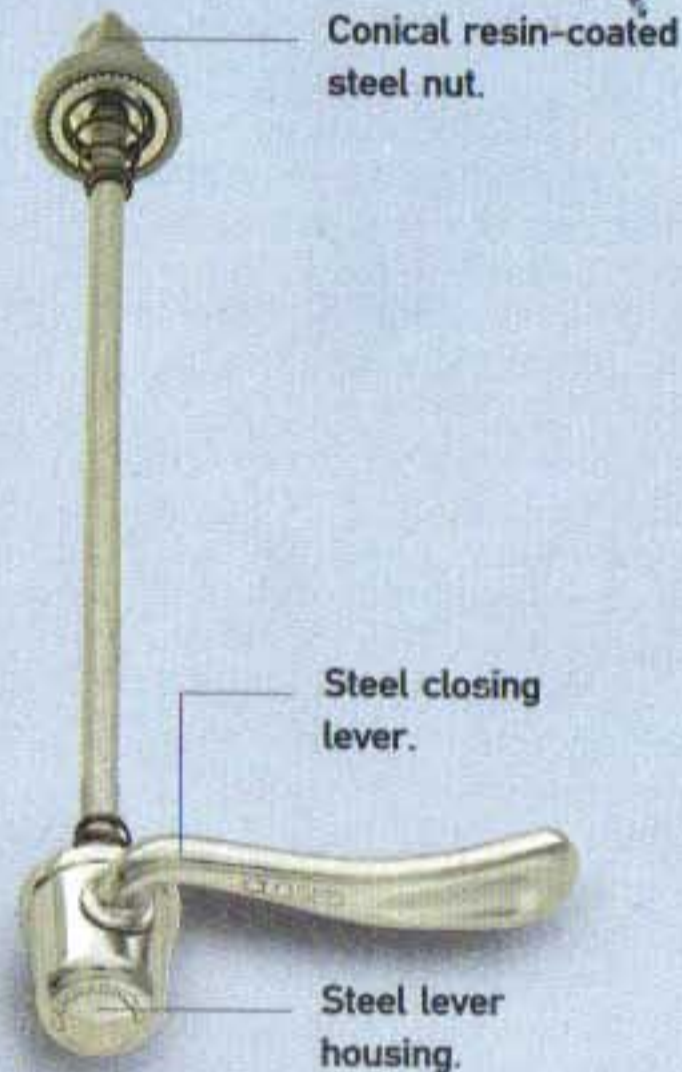

Conical resin-coated steel nut.

Steel closing lever.

Steel lever housing.

new HUBS and QUICK RELEASE SKEWERS

The new 9-Speed Athena hubs feature a significant reduction in weight and a new quick release design. The rear cassette hub in particular has an aluminum freewheel body with a new spline pattern especially designed to accept the new EXA-DRIVE MK2 cassettes. The freewheel pawl carrier and hub-axle are made of steel and the rear hub has a standard OLD-dimension of 130 mm. The total weight saving obtained with the new hub equals 43 grams. Thanks to a new design the quick release skewers weigh 19 grams less a pair. The closing lever and lever housing body are of steel, while the new conical adjusting nut is made of resin-coated steel.

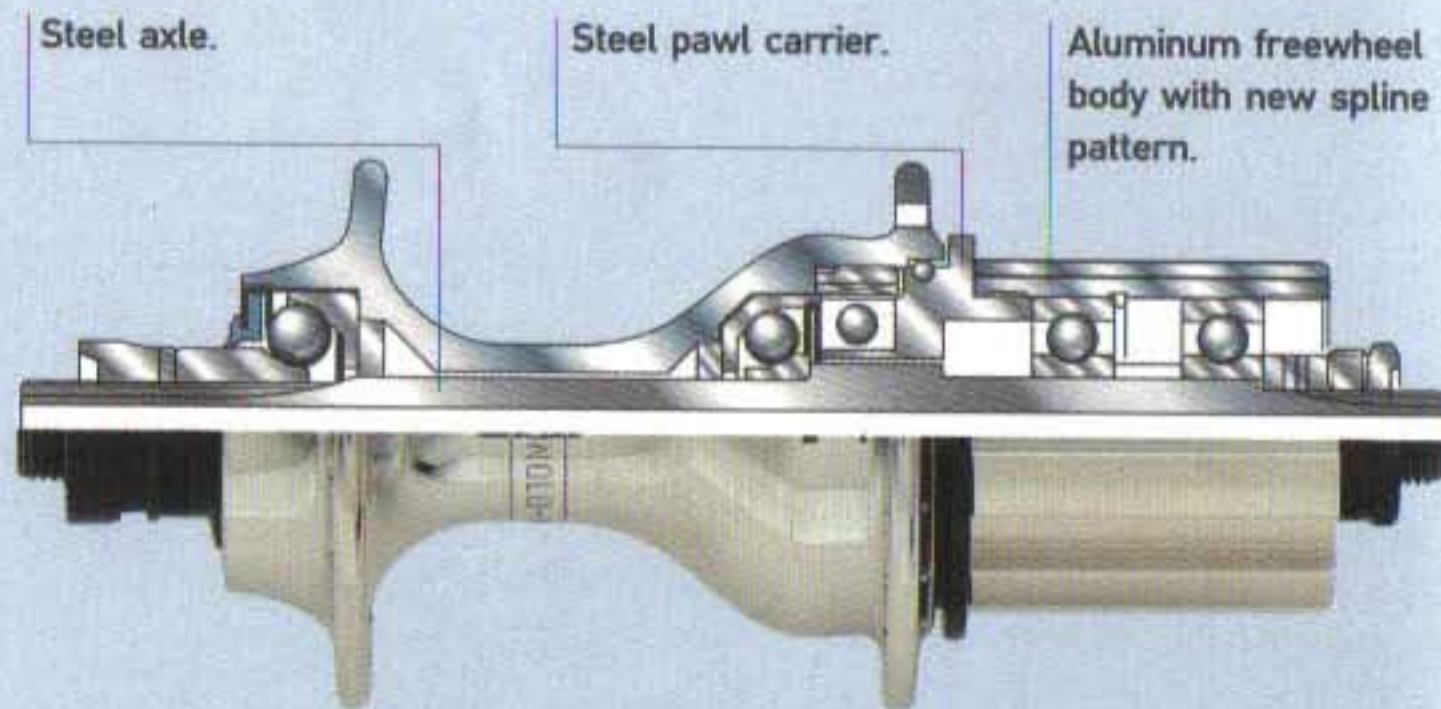

Steel axle.

Steel pawl carrier.

Aluminum freewheel body with new spline pattern.



new PEDALS



The new Athena pedals share all the advanced features of Campagnolo's Pro-Fit pedal line: light weight, compact size, ample foot support, a consistent cleat engaging tension, regardless of the preselected release tension and greater cornering clearance. A specific feature of the Athena model is the use of a steel axle with two radial sealed bearings which allow for very efficient power transmission and high durability of the bearing races. As with the other models of the line, the cleat bolt pattern is compatible with the majority of quality cycling shoes on the market and pedal installation and maintenance

can be performed with standard tools. Compared to last year's model, a pair of Athena Pro-Fit pedals weighs 91 grams less.

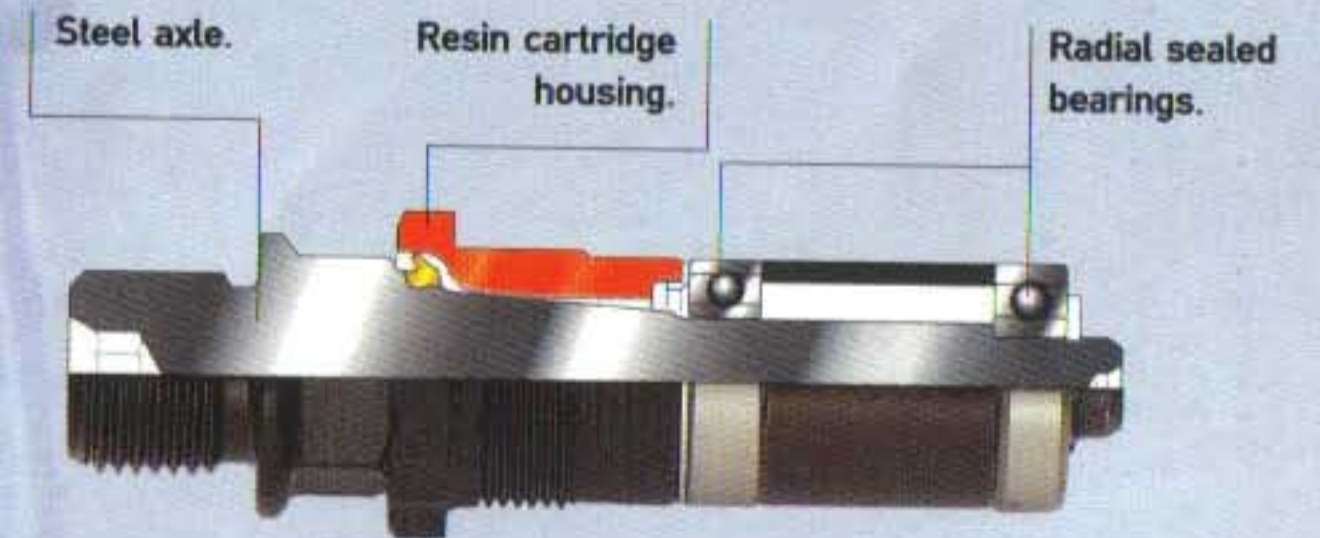

Steel axle.

Resin cartridge housing.

Radial sealed bearings.



groups

CAMPAGNOLO



VELOCE

VELOCE



groups

CAMPAGNOLO



new 9-speed ERGOPOWER

Thanks to the 1998 Veloce groupset the 9-Speed system is now available for mid-range bicycles as well. All drivetrain components have been renewed, starting with the Ergopower levers. The new right-hand 9-Speed Ergopower lever has been indexed for rear derailleur shifting with a 9 Speed cassette. It also contains a new compensation spring for smoother shifting operation.

new 9-speed REAR DERAILLEUR

The new Veloce rear derailleur has been completely redesigned according to the requirements of the 9-Speed drivetrains for double and triple chainrings. The main innovations are: extended

New mounting bolt.

New cable clamping bolt.

New lower pulley.



derailleur travel to enable shifting over a total of nine sprockets, narrower derailleur pulleys for a combined use with the narrower 9 Speed chain, thinner derailleur cage plates in order to provide sufficient clearance between the internal cage-plate and the drivetrain spokes. The derailleur also has a new hollow and lighter mounting bolt and an improved design, thanks to new recessed adjusting screws and a new cable clamping bolt. Both the standard and the long cage Veloce 9 Speed rear derailleurs are equipped with the new lower pulley for improved chain guidance and smoother and more silent chain transmission. The materials used: the top plate of the parallelogram and the outer derailleur cage plate are of aluminum, while the inner plates are made of steel.

new 9-speed CHAIN

The new Veloce 9-speed chain is 100 percent designed and produced by Campagnolo. It features burnished rollers and burnished internal link plates with nickel-Teflon coated outer link plates. Another noteworthy innovation which was adopted from the high-end 9-Speed chain is a set of special chamfers (patented Floating Link Action) which provide for perfect meshing of the chain on chainrings, sprockets and on the new lower derailleur pulley delivering a smooth and silent chain transmission. The new chain weighs 25 grams less than the previous 8 speed model.



new 9-speed CASSETTES

Thanks to the introduction of the 9-Speed system, the new Veloce cassettes weigh less and offer improved performance. Veloce cassettes are made up of nine individual chrome-plated (no longer zinc-coated) steel sprockets. The EXA-DRIVE profiles of the sprocket teeth interact perfectly with the chamfered link-plates of the 9-Speed chain. 9-speed Veloce cassettes are available in four different combinations.

new HUBS and QUICK RELEASE SKEWERS

The 9-speed Veloce groupset features a new rear cassette hub and new quick release skewers. This year's hub is 43 grams lighter and has an aluminum freewheel body with a steel pawl carrier and a steel axle. The new quick release design delivers a weight saving of 21 grams per pair. The skewer lever and the lever housing are of steel, while the adjustable nut is made of resin-coated steel.

new BRAKES

A very important innovation refers to the brakes: from 1998 on, the Veloce groupset is equipped with Dual-Pivot brakes. Compared to the Monoplaner model, these new brakes deliver a more powerful and balanced braking action. The new Veloce Dual-Pivot brakes have a self-aligning cable guiding system which maintains the brake cable in the correct position during braking operation. The brake shoes have built-in wheel guides.

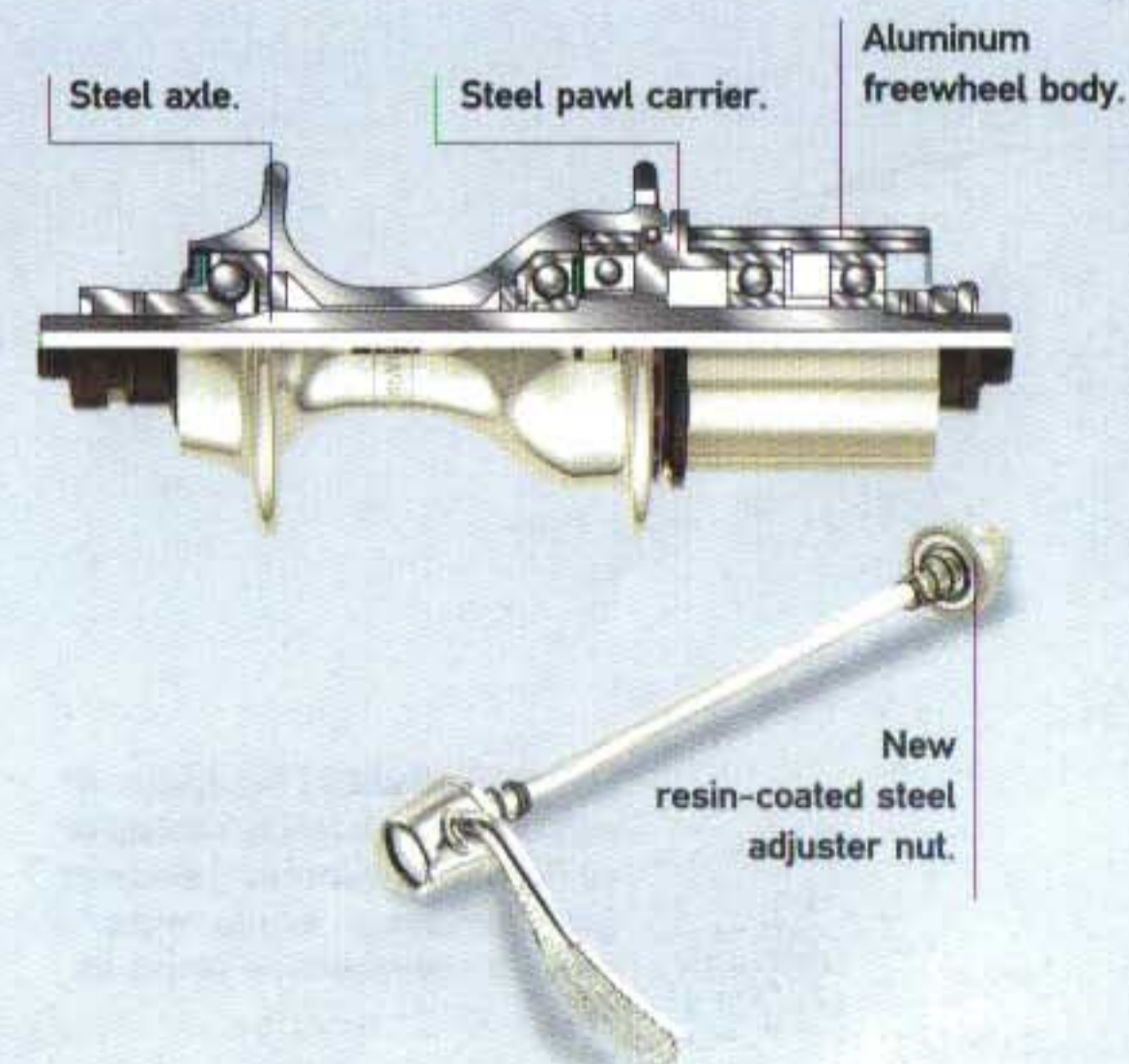



groups

CAMPAGNOLO



MIRAGE

MIRAGE



NEW ERGOWPOWER The latest version of Campagnolo's integrated Ergopower controls has been greatly improved, thanks to the use of a compensation spring on

the right hand Ergo-lever which complements the use of an equivalent spring introduced on all 1997 left hand shifters.

NEW BRAKES This year the Mirage group is equipped with Dual Pivot brakes, which offer a more powerful, responsive and progressive braking action.

Mirage Dual Pivot brakes come with brake shoes featuring built-in wheel guides.



groups CAMPAGNOLO



AVANTI

AVANTI



NEW ERGOPOWER The new Avanti Ergopower controls now have the same mechanical features as all the medium and high-end Ergopowers, featuring two separate shifting

levers for up and down shifting. The right hand Avanti Ergopower too, contains a spiral compensating spring for easier shifting operation.

NEW BRAKES Campagnolo's entry-level groupset Avanti, now not only offers supreme performance levels, but also absolute reliability, thanks to the adoption of Dual Pivot brakes.

The new Avanti brakes are equipped with brake shoes featuring built-in wheel guides. The result is a more powerful, responsive and progressive braking action.



groups

CAMPAGNOLO

The Record Track groupset has been updated with a new Record seat-post and new Pro-Fit Record pedals. This groupset is now even lighter while still retaining Campagnolo's legendary reliability.

With the Record Track groupset famous champions have won Olympic and World Championship titles as well as setting prestigious World Hour records - an unparalleled history of success in cycling competition underlining the quality and continuous innovation dedicated to Campagnolo components.

RECORD TRACK

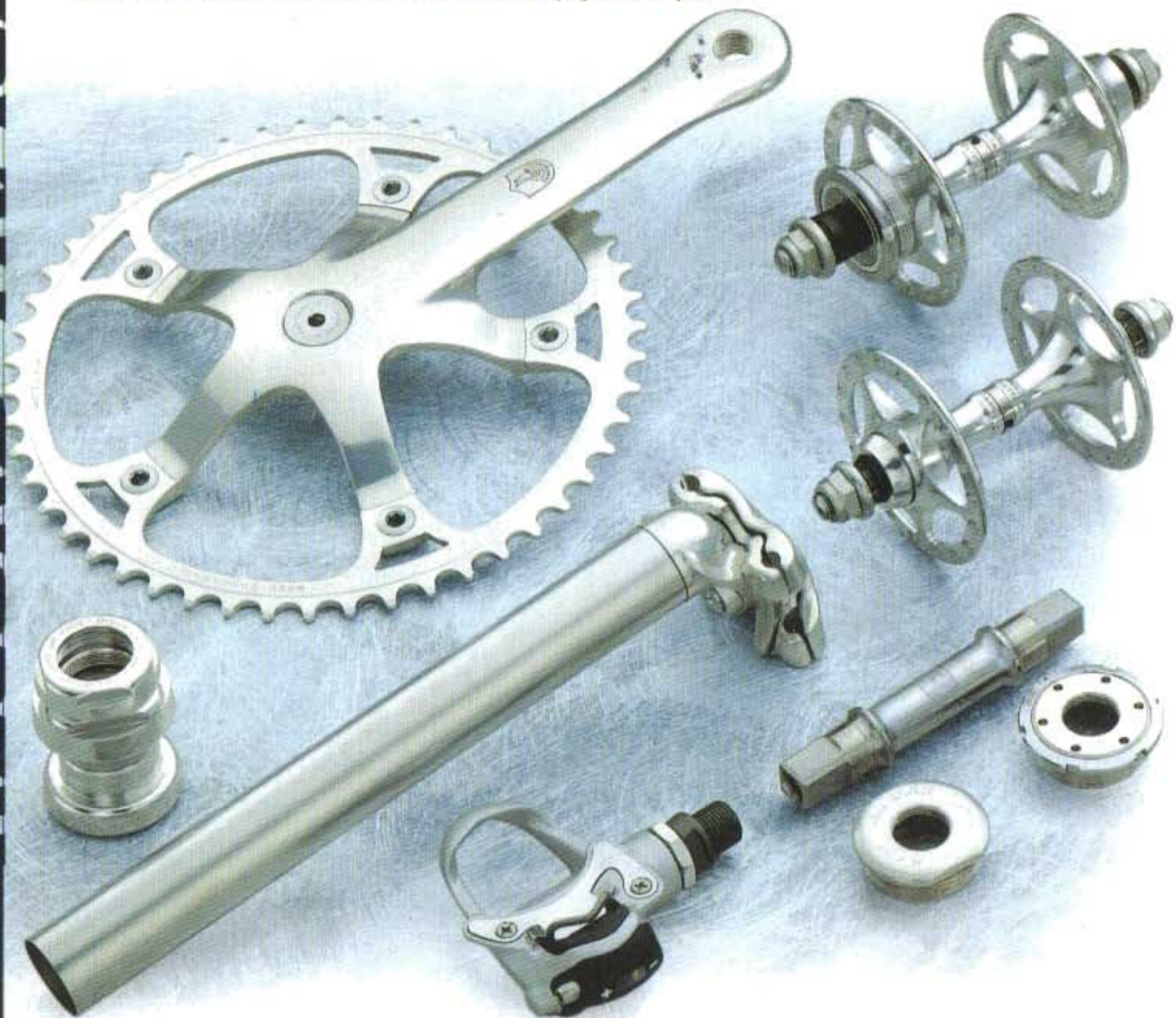

TRIATHLON



Campagnolo has always paid special attention to the sport of triathlon and is pleased to note that it represents a sport which enjoys growing popularity and with its as well as having gained admission to the Olympic Games in Sydney. The Triathlon components for '98

include chainwheels with special Exa-Drive tooth profiles, and specific Bar-End controls for 9-speed systems. Top riders such as Lothar Leder, Greg Welch, Luc van Lierde and Fernanda Keller choose Campagnolo to continue on the road that leads to victory!



fluid-dynamic WHEELS

BORA

The new BORA TITANIUM

wheel is intended for competition use, where maximum lightness and aerodynamics are of fundamental importance in achieving a major victory. The Bora Titanium wheel is made of an extremely rigid, deep-sectioned (50 mm deep) carbon-fiber rim which allows the use of only 12 spokes for both the front and rear wheels. In order to provide equivalent braking performance as with more standard aero wheels, the carbon side-walls of the rim are covered with an aluminum structure, thus providing an ideal surface for reliable braking action in both dry and wet weather conditions. Bora wheels are equipped with superlight H.P.W. hubs, titanium axles and an aluminum freewheel body. Being specifically designed for use in competition, Bora wheels are only available in one version for tubular tires. The rear hub is equipped with an aluminum freewheel body featuring a new 9-Speed spline pattern, which is compatible with both the '97 9-Speed Exa-Drive cassettes and the new EXA-DRIVE MK2 sprocket sets. Bora wheels come with the new Campagnolo wheelbag.



New aluminum braking surface.

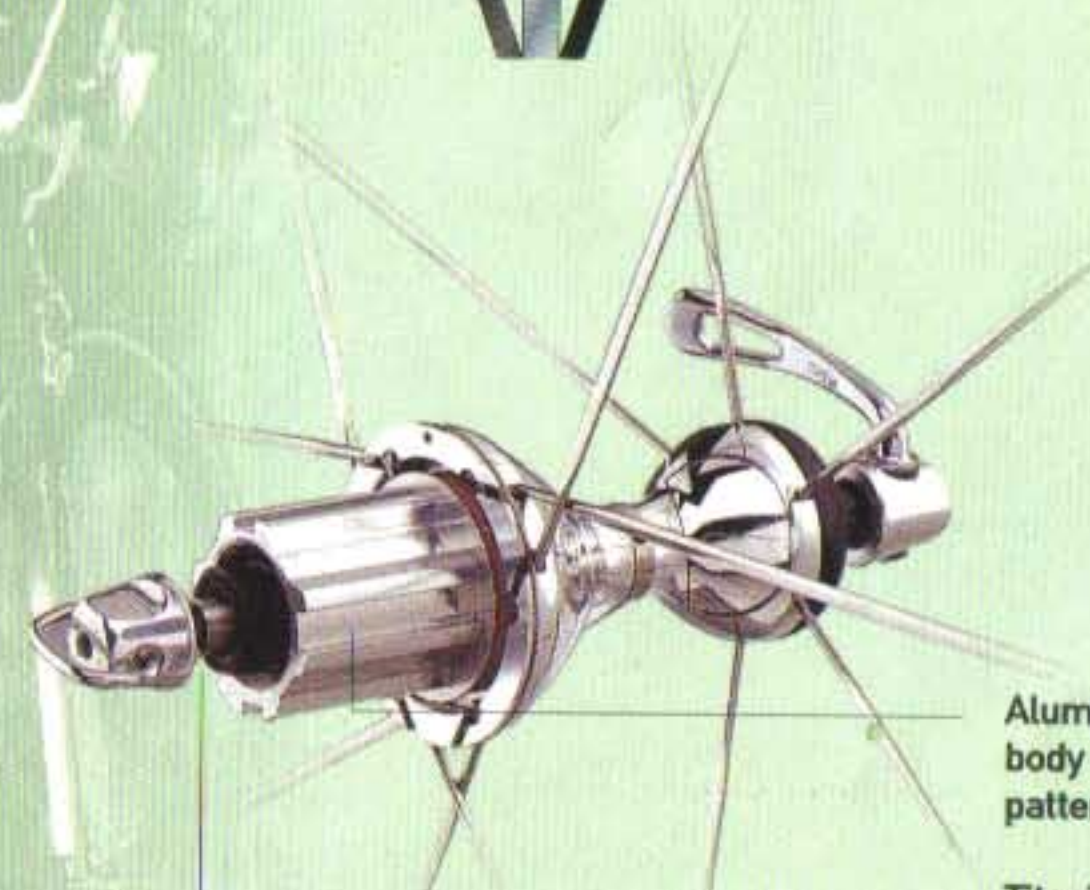

Aluminum freewheel body with new spline pattern.

Titanium axle.

BORA TITANIUM

code	model	spokes	Ø	tyre	section	OLD	weight g
R-B0101	front road	12	28"	tubular	19	100	830
R-B0201	rear road 9-speed	12	28"	tubular	19	130	1040

BORA



fluid-dynamic WHEELS



SHAMAL acts as a synonym

for aerodynamics and rigidity and has been adopted as the preferred wheel of top riders throughout the world. The '98 Shamal Titanium range is designed for the use of 12 spokes on the front wheel and 16 on the rear. As with

Bora wheels, Shamal Titanium wheels are equipped with super-light H.P.W. hubs, titanium axles and an aluminum freewheel body with a new 9-Speed spline pattern. Shamal wheels come with the new Campagnolo wheelbag.



SHAMAL TITANIUM

code	model	spokes	Ø	tyre	section	OLD	weight g
R-SH101	front road	12	28"	tubular	19	100	800
R-SH305	front road	12	28"	clincher	19	100	825
R-SH212	rear road 9-speed	16	28"	tubular	19	130	1050
R-SH404	rear road 9-speed	16	28"	clincher	19	130	1080

SHAMAL 16-TRACK

code	model	spokes	Ø	tyre	section	OLD	weight g
R-SH106	front track	16	28"	tubular	19	100	920
R-SH204	rear track	16	28"	tubular	19	120	1010



fluid-dynamic WHEELS

VENTO 16-HPW

code	model	spokes	Ø	tyre	section	OLD	weight g
R-VE101	front road	16	26"	tubular	19	100	788
R-VE310	front road	16	26"	clincher	19	100	833
R-VE311	front road	16	28"	clincher	19	100	914
R-VE201	rear road 9-speed	16	26"	tubular	19	130	1040
R-VE410	rear road 9-speed	16	26"	clincher	19	130	1088
R-VE411	rear road 9-speed	16	28"	clincher	19	130	1133



VENTO 16-HPW
wheels
are ideal

for a use in competition and, also being available in a so-called 26"-diameter version, they represent the ideal choice for custom built Triathlon bikes. The H.P.W. hub on the Vento wheel contains a steel axle and a steel pawl carrier, while the freewheel body is made of aluminum, featuring the

new 9-Speed spline pattern for both '97 type 9-Speed cassettes and the new EXA-DRIVE MK2 sprocket-sets. The quick-release skewers are the same as on standard type Chorus hubs. Vento wheels come with the Campagnolo's new wheelbags.

Thanks to a series of modifications, the new **ZONDA 16-HPW** wheels, now fall into the category of Campagnolo's top of the line FLUID-DYNAMIC wheels. Zonda wheels are equipped with new H.P.W.-type hubs, featuring 16 aero blade spokes, steel axles and a steel pawl carrier. The freewheel body is made of aluminum with the new 9-Speed spline pattern for both '97 Exa-Drive cassettes and the new EXA-DRIVE MK2 sprocket-sets. The quick release skewers feature new adjuster nuts of resin-coated steel.



ZONDA 16-HPW

code	model	spokes	Ø	tyre	section	OLD	weight g
R-Z0307	front road	16	28"	clincher	19	100	857
R-Z0407	rear road 9-speed	16	28"	clincher	19	130	1104

VENTO

ZONDA



fluid-dynamic WHEELS

SCIROCCO 20

code	model	spokes	Ø	tyre	section	OLD	weight g
R-SC309	front road	20	28"	clincher	19	100	887
R-SC409	rear road 9-speed	20	28"	clincher	19	130	1113
R-SC410	rear road 8-speed	20	28"	clincher	19	130	1193

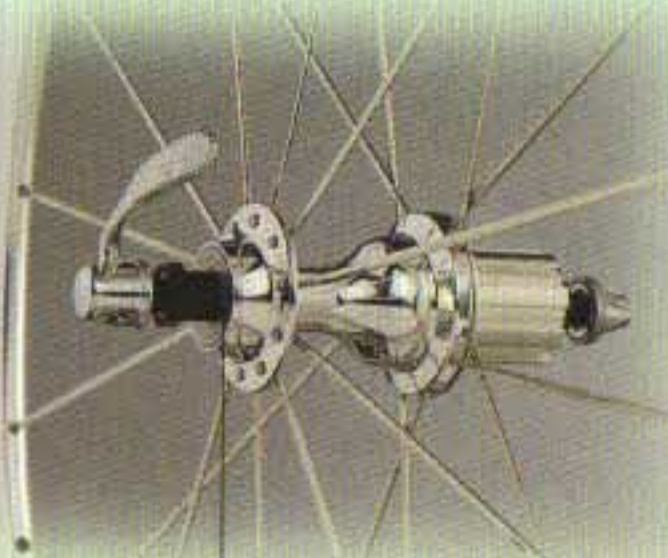

New HPW-Hybrid hub.



Also the 1998 version of the **SCIROCCO 20** wheel features important innovations.

In spite of the fact that this wheel was not specifically designed for competitive cycling, it now offers amazing performance levels. The rear wheel is built with a completely new hub-design called HPW-Hybrid. The left hand side of the hub has a traditional type hub-flange (for elbow spokes), whereas the drivetrain side of the hub, with higher spoke tension, has a HPW-type design for the use of bladed, hammer-head spokes, thus considerably increasing

the overall durability and strength of the wheel.

The new hybrid hub also provides wider and improved wheel dish. The rear hub is assembled with a steel axle and steel pawl carrier, as well as an aluminum freewheel body containing a set of sealed bearings. Scirocco wheels are available in both an 8-speed or a 9-speed version featuring an aluminum freewheel body.

The EURUS wheel

has been specifically designed for the major bicycle manufacturing companies and meets the requirements of a wide range of cyclists seeking a reliable and modern wheel featuring state-of-the-art technology, without having to go to the expense of a top of the range wheel. Eurus wheels have an aerodynamic V-shaped rim profile with a 30 mm deep rim-section (10 mm more than a conventional rims). The braking surface carries a special SWT (Side Wall Treatment) providing increased braking performance in dry and wet weather conditions. Both the front and rear hub are assembled with highly-durable, smooth running and maintenance-free sealed bearings.



EURUS 20

code	model	spokes	Ø	tyre	section	OLD	weight g
R-EU300	front road	20	28"	clincher	19	100	878
R-EU400	rear road 8-speed	20	28"	clincher	19	130	1151



fluid-dynamic WHEELS

GHIBLI is a disc wheel

used by elite pro-riders during time trials in road and track racing. Thanks to the use of advanced aerospace materials, the weight of a Ghibli wheel compares to that of any conventional high-quality bicycle wheel, while the extremely high vertical elasticity characterizing this wheel makes it much more comfortable than other disc wheels. The new model for 1998 is 85 grams lighter due the use of a superlight hub containing a titanium axle and a titanium pawl carrier and an aluminum freewheel body with a 9-Speed spline pattern. The special Ghibli freewheel body can hold eight 9-Speed-sprockets (with 9-Speed spacing) of the following cassette models: 1997-style 9-speed Record, Record Titanium and Chorus and 1998-style 9-speed Veloce. Ghibli wheels come with the new Campagnolo wheelbag.

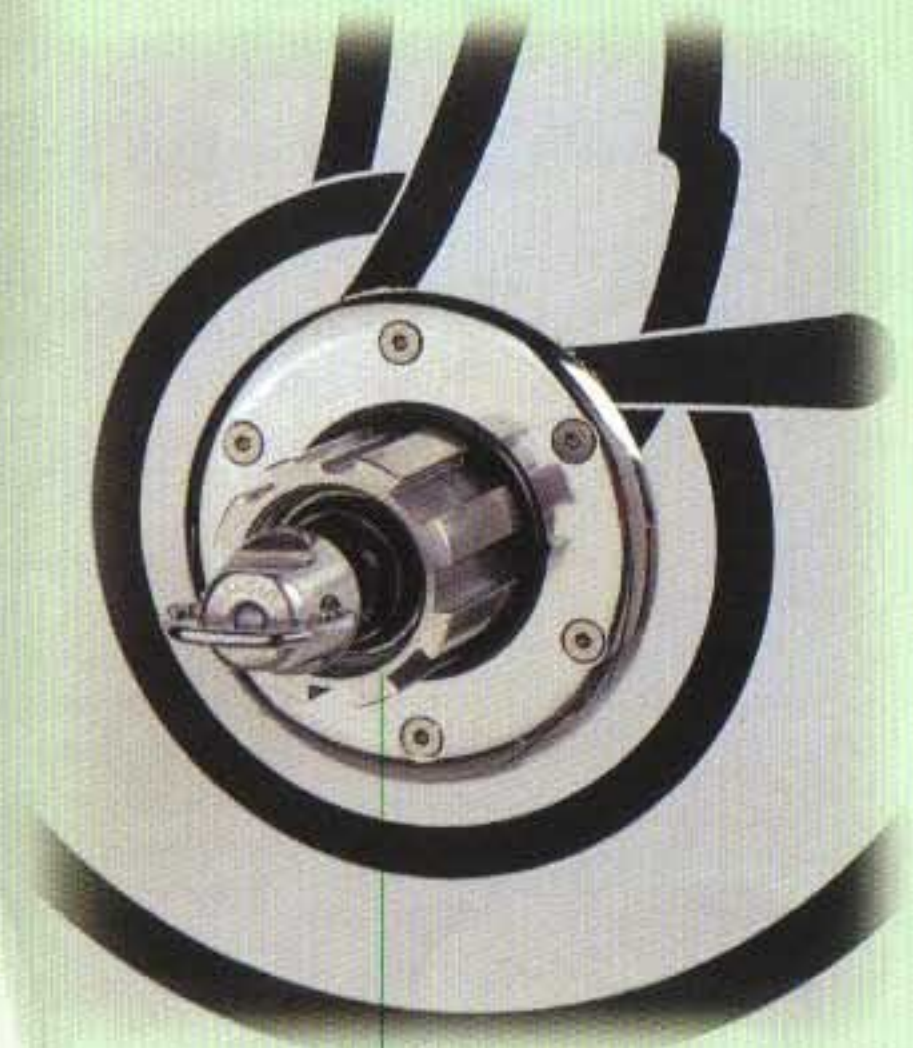

New superlight Ghibli rear hub for road racing.

GHIBLI

code	model	Ø	tyre	section	OLD	weight g
R0071	front track	26"	tubular	18	100	863
R0097	front track	28"	tubular	18	100	954
R0541	rear track It. or BSC thread	28"	tubular	18	120	1040
R-GH001	rear road	28"	tubular	18	130	1115



climb-dynamic WHEELS

Campagnolo's new CLIMB-DYNAMIC wheels, ELECTRON and PROTON, fill a

gap that had been left in the field of top-performance competition wheels. The extreme conditions of modern competitive cycling have created a growing demand for bicycle wheels specifically designed for

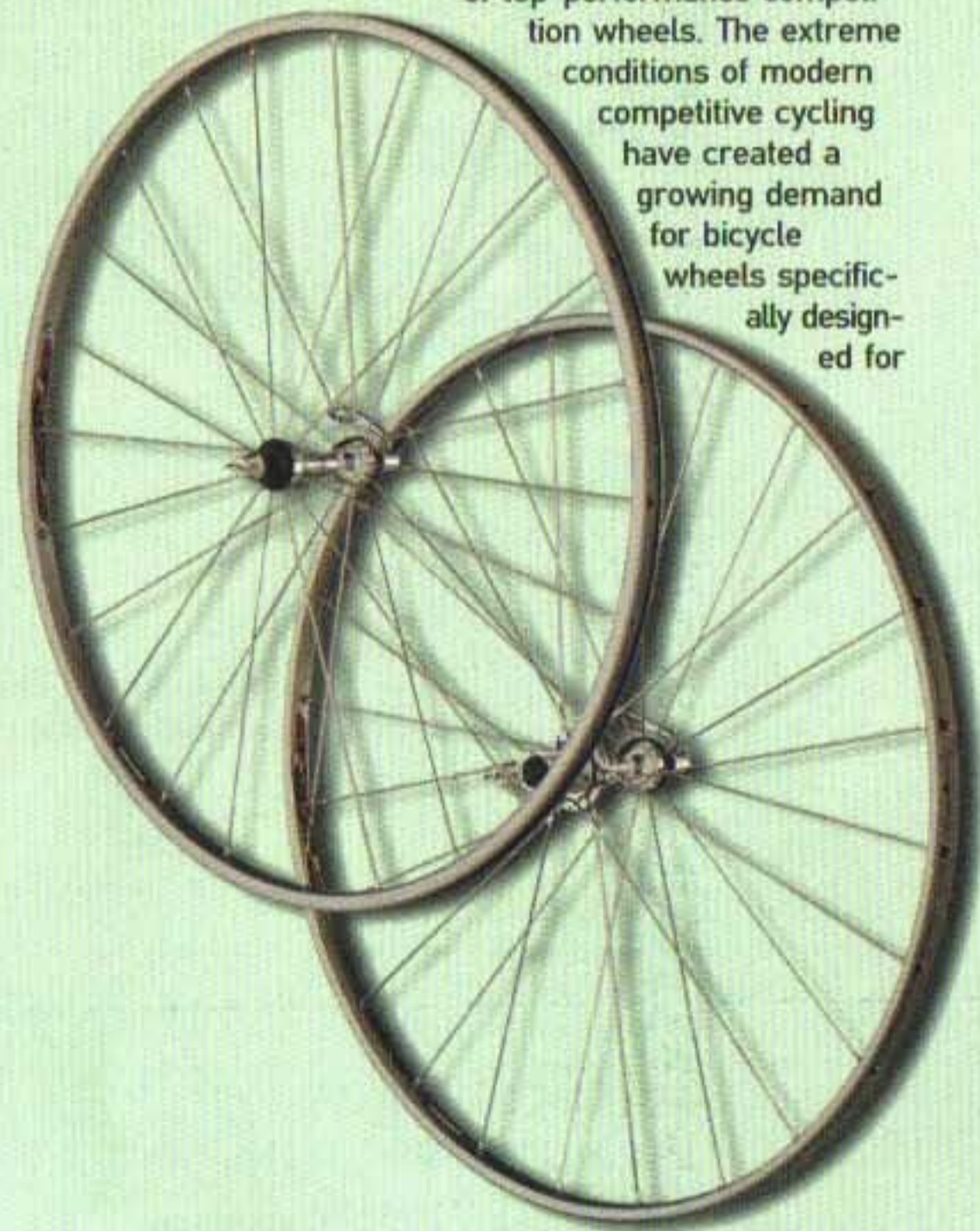

New titanium-gray finish.

All Climb-Dynamic wheels have rims with treated side walls.

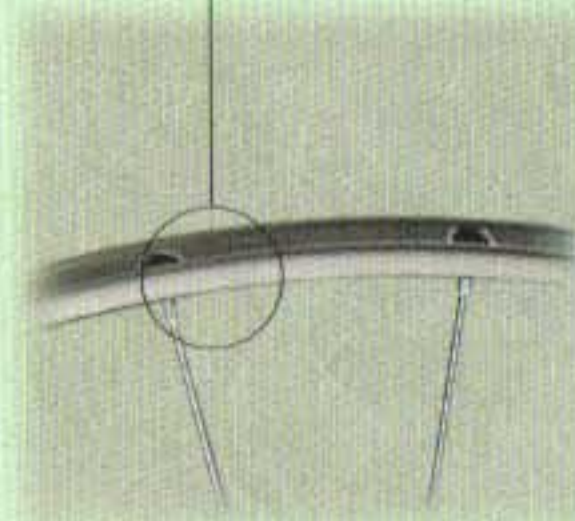

time-trials with many hills as well as climbs in general; what more and more riders are asking for, is a featuring light weight together with high rigidity, in order to allow maximum efficiency of the power generated through the athlete's effort, especially whenever aerodynamics are of secondary importance. Hence this new generation of wheels represent a precious addition to Campagnolo's famed high-rim profile FLUID-DYNAMIC wheels. The rider has the option between a complete range of fast wheels designed for predominantly flat terrain, where the extraordinary aerodynamics of Campagnolo's Fluid-Dynamic wheels are the predominant factor, and a distinct category of fast wheels for mainly hilly or mountainous terrain, where light weight and rigidity are of priority concern. ELECTRON and PROTON also represent an ideal supplement for bicycles equipped with ultralight componentry and their elegant titanium-gray finish turns them into a perfect match for any style of frame-set.

All Climb-Dynamic wheels feature H.P.W. hubs providing wider and more balanced wheel-dish.

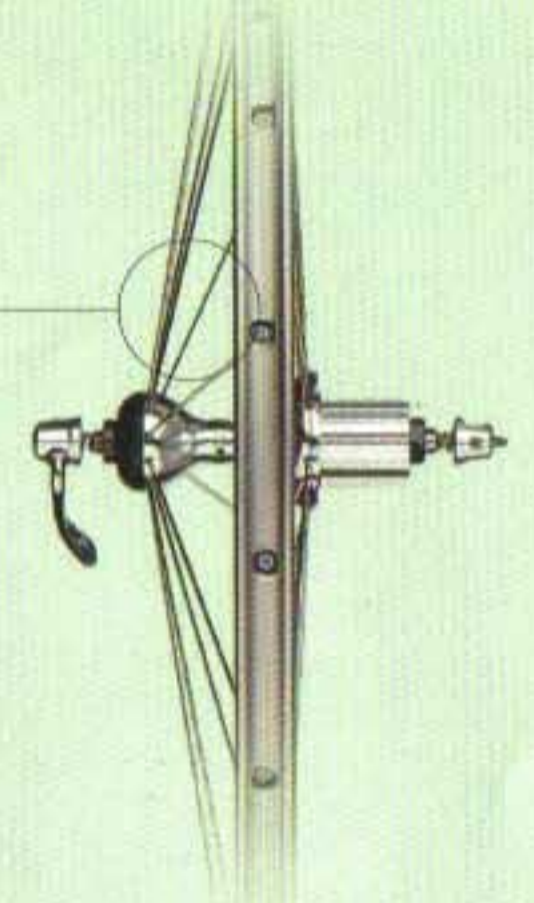

Cross-section of Climb-Dynamic wheels for clincher tires.

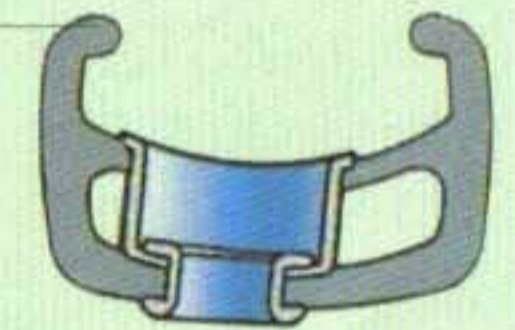

Cross-section of Climb-Dynamic wheels for tubular tires.

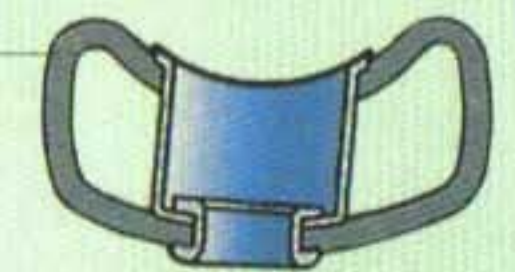



climb-dynamic WHEELS

ELECTRON

ELECTRON wheels are the lightest-weight



model in the Climb-Dynamic range. They come in two versions: for tubular and for clincher tires. The rim used for the tubular version of the Electron wheel owes its remarkably light weight to the use of a special aluminum alloy (7000 series T7), while the clincher version is manufactured from a 6000 series T6 alloy. Both models are assembled to superlight H.P.W.

hubs with 24 custom spokes featuring asymmetric flatted portions at the cross sections of the lacing pattern in order to achieve a wider wheel dish. The rear hub of the Electron wheels is assembled with a titanium axle and a titanium pawl carrier as well as an aluminum freewheel body featuring the new 9-Speed spline pattern to accommo-



date EXA-DRIVE MK2 cassettes. The materials used to manufacture these wheels have been carefully studied and selected based on their remarkable features which combine low weight and high reliability. Electron is the result of a major project aimed at providing a set of climbing wheels with a total weight of only 1,589 grams for all cyclists requiring wheels that on top of their virtues of light weight and high rigidity, also provide immediate response and maximum efficiency in case of sudden and powerful accelerations of the bicycle. Electron wheels come with Campagnolo's new wheelbags.

ELECTRON

code	model	spokes	Ø	tyre	section	OLD	weight g
R-EL101	front road	24	28"	tubular	22	100	681
R-EL301	front road	24	28"	clincher	20.2	100	733
R-EL201	rear road 9-speed	24	28"	tubular	22	130	905
R-EL401	rear road 9-speed	24	28"	clincher	20.2	130	965

ELECTRON



climb-dynamic

WHEELS

PROTON

code	model	spokes	Ø	tyre	section	OLD	weight g
R-PR301	front road	24	28"	clincher	20.2	100	745
R-PR401	rear road 9-speed	24	28"	clincher	20.2	130	1015



PROTON wheels are built by

applying the same technology used in manufacturing Electron wheels, but with less sophisticated materials, thus making them affordable to a greater number of riders demanding an innovative product, which need not necessarily represent the very top of the line. Proton wheels are available in a single version for clincher tires only and are built with the same rim used for the clincher version Electron wheel. The main difference between the two models lies in the materials used on the internal parts of the hubs. Proton wheels feature H.P.W.

hubs, with steel axles and a steel pawl carrier and an aluminum freewheel body

(with the new 9-Speed spline pattern) on the rear. Also Proton wheels are tensioned by 24 custom spokes (featuring asymmetric flattened portions at the cross sections of the lacing pattern).

Proton wheels come with Campagnolo's new wheelbags. Innovation, lightness and reliability at a competitive price are the winning features of the new Proton wheels.

PROTON



rim

CAMPAGNOLO

RANGE 1998

Campagnolo's RIMS range

for 1998 represents the result of a wide experience acquired over years of research and manufacturing technology. The '98 models are aimed exclusively for equipping road bikes. Features common to all Campagnolo rims are durability, reliability strength and excellent braking performance. These attributes are naturally linked to the careful choice of materials used for manufacturing the rims, as well as to the advanced design techniques applied in designing the various cross-sections of rim profiles together with an analysis of numerous possible rim surface and side wall treatments. The applied side wall treatments have significantly improved braking performance, particularly in wet weather conditions. Campagnolo rims feature two different side wall treatments:



H.P.B. CONTROL

"High Performance Braking Control"

SWT

"Side Wall Treatment"

H.P.B. (High Performance Braking) Control. This process involves a micro-sandblasting of the braking surfaces, which are subsequently treated for additional enhancement of the coefficient of friction generated by the brake pads and the rim's braking surface. SWT (Side Wall Treatment) is a special machining of the rim's braking surfaces which renders them perfectly flat. Both these treatments provide rim drying times which are notably lower than those achieved by rims with untreated side-walls, leading to a considerable reduction in braking distances without increasing brake pad wear. The eyelets used on the entire range of rims are of stainless steel, a material which is extremely resistant to corrosion and also facilitates the wheel-building process especially during spoke tensioning.

ROAD



rims

CAMPAGNOLO

model	ATLANTA 1996	BARCELONA 92	MONTREAL 76
code	C-AT11SI	C-BA11HA	C-MO02HA
tyre	clincher	tubular	clincher
Ø ETRTO	622 mm	632 mm	622 mm
drilling	32-36	32-36	32-36
eyelets	no	stainless steel	stainless steel
alloy	6000-T6	7000-T6	6000-T6
valve Ø	6.5 mm	6.5 mm	6.5 mm
weight	590 g	410 g	415 g
H.P.W.	●		
S.W.T.		●	
hardox		●	●
satin			
silver	●		

ATLANTA 1996

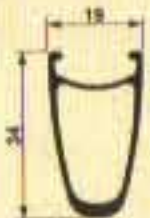

BARCELONA 92



MONTREAL 76



MEXICO 68

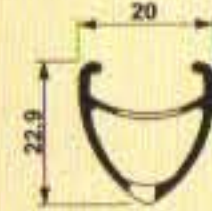

MOSKVA 80

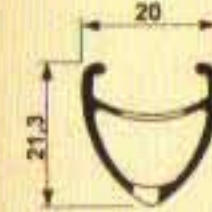

BERLIN 36

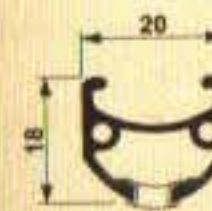

SYDNEY 2000

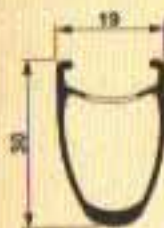

model	MEXICO 68	MOSKVA 80	BERLIN 36	SYDNEY 2000
code	C-MX01SA	C-MV01TI	C-BE01SA	C-SY01SA
tyre	clincher	clincher	clincher	clincher
Ø ETRTO	622 mm	622 mm	622 mm	622 mm
drilling	32-36	32-36	32-36	32-36
eyelets	no	no	stainless steel	no
alloy	6000-T6	6000-T6	6000-T6	6000-T6
valve Ø	6.5 mm	6.5 mm	6.5 mm	6.5 mm
weight	485 g	435 g	535 g	553 g
H.P.W.	●	●		
S.W.T.			●	●
hardox				
satin	●		●	●
titanium		●		



service

CAMPAGNOLO



CAMPAGNOLO intends to make original spare parts readily available to all users of its components. This is a major service factor enabling the customer to keep his machine in perfect function and pristine maintenance. The parts most subject to wear and tear (derailleur jockey pulleys, brake pads, brake lever hoods, cables and casings, cleats and various parts for Pro-Fit pedals) are all available at retail sales points, in sealed packages marked as "Original Spare

Parts". Therefore it is easy to immediately recognize original Campagnolo Spare parts. The exclusive use of original spare parts is essential in order to guarantee perfect functioning and durability of the components. For the new Pro-Fit pedals two new sealed packages are available which include a set of cleats (with or without float), two rubber inserts, bolts and washers and two adhesive anti-slip patches for use on shoes with carbon-fiber soles. A separate package with two engaging hooks including bolts and washers is also available. Thus it is possible to replace just the resin portion of the cleat, without purchasing the complete cleat engaging devices. There is also a special spare parts package containing two engaging springs for the pedals.

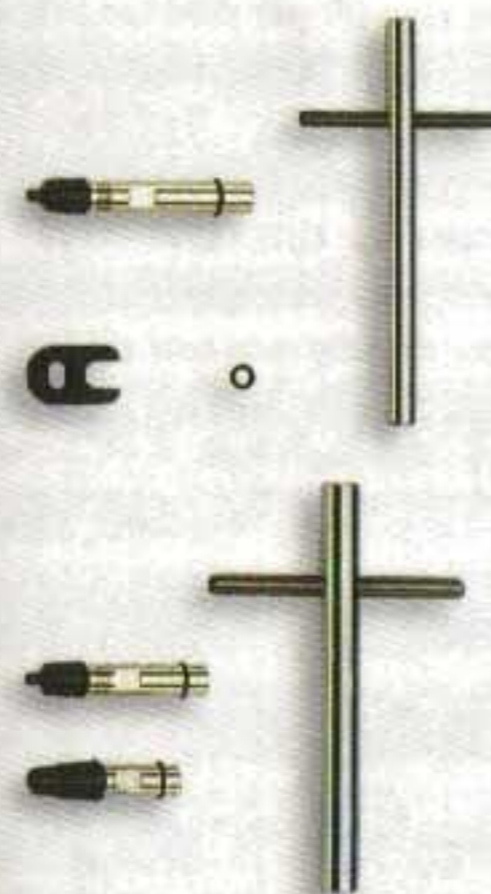

CAMPAGNOLO offers a more and more

extensive range of wheels in order to meet the requirements of today's cyclists. Their increasingly wide diffusion has called for the introduction of a wheel carrying bag, for easier transportation and extra protection of the wheels. All Campagnolo's top of the line wheels (Bora, Shamal, Vento, Ghibli, Electron and Proton) will be supplied with a bag which is not only a practical item, but also carries an attractive design and features a great attention to detail, turning it into a highly technical product. The bag can easily accommodate a wheel with the quick release skewer inside the hub, as a special reinforcement material has been applied to both outside center

sections of the bag. A large pocket, big enough to hold a spare inner tube and one or two tools is sewn inside the bag. The new wheel bags are also available to all current owners of Campagnolo wheels and can be purchased individually for wheels in the 1998 range that do not come with the bag. All Campagnolo Fluid-Dynamic wheels are supplied with a matching valve extension. Furthermore two special spoke-tensioning tools are available for all Fluid-Dynamic wheels, one exclusively for the Bora wheel and one for Shamal, Vento and Zonda wheels.



RECORD 9 Speed

technical specifications

REAR DERAILLEUR	RD-19RE ● 9 Speed - Anodized - maximum sprocket: 26 teeth - Capacity: 27 teeth - Titanium hanger and pivot bolt
FRONT DERAILLEUR	For double crankset - Capacity: 15 teeth - Max. chainring: 54 teeth - Adjustable spring - Lightened cage
	FD-31SRE ● Braze-on - Anodized
	FD-31FRE ○ Clip-on Ø 28,6 mm - Anodized
	FD-12FRE ○ Clip-on Ø 32 mm - Anodized
	FD-13FRE ○ Clip-on Ø 35 mm - Anodized
ERGOPOWER	EC-19RECG ● Carbonfibre body - Ball bearings - Light alloy hardware - Triple compatible - Compensation spring Anodized levers - w/cables and prelubricated casings - No brake housing ferrules - Lightened shifting lever
SHIFTING LEVERS	SL-09SRECG ○ 9 Speed - Down tube - Indexed
FRONT HUB	HB-30RE ● O.L.D.: 100 mm - Spoke holes: 32/36 - Sealed bearings - Titanium axle - QR with aluminium lock nut
REAR HUB	FH-19RE ● O.L.D.: 130 mm - 9 Speed aluminium freewheel body (MK2) - Spoke holes: 32/36 - Titanium axle and mechanism
CASSETTES	CS-19RE ● 9 Speed Exa-Drive MK2 - Steel/Ti - Nickel-chromed - With light alloy carrier Combinations: 11/21 - 11/23 - 12/21 - 12/23 - 13/23 - 13/26
	CS-19RETI ○ 9 Speed Exa-Drive MK2 - Titanium - With light alloy carrier - Combinations: 12/21 - 12/23 - 13/23 - 13/26
CHAIN	CN-19RE ● 9 Speed - "Floating Link Action" - Nickel-Teflon finish - 114 links - 8 Speed compatible
CRANKSET	FC-2RE ● Low-profile cranks: L. 170 - 172,5 - 175 mm - Anodized - Light alloy chainring fixing bolts and nuts Exa-Drive chainrings: 39 x 52 - 42 x 52 - 39 x 53 - 42 x 53
BOTTOM BRACKET	Carbon fibre sealed cartridge - IT 36 x 24 tpi - BC 1,370 x 24 tpi - Oversize hollow axle - Aluminium cups
	BB-31RECG ● For double crankset - Axle L 102 - IT thread
	BB-33RECG ○ For double crankset - Axle L 102 - BC thread
PEDALS	PD-52REQR ● QR - PRO-FIT - With floatings cleats - Thread: 9/16" x 24 tpi - Titanium axle - 3 bearings Adjustable release tension
BRAKES	BR-44RE ● Dual-Pivot - Height 39±50 mm - Stainless steels ball bearings - Anodized
BRAKE LEVERS	BL-22RECG ○ Anodized
SEATPOST	SP-20RE ● With screw and locking nut - 250 mm - Steel tube - Light alloy head - Ø 25 / 27,2
HEADSET	HS-21RE ● Thread BC 1" x 24 tpi - Balls Ø 3,96 mm (upper) and 4,76 mm (lower) - Overall stacking height: 36,5 Grease port - Anodized
	HS-01REHD ○ For unthreaded steerers Ø 1" (25,4mm) - Height: 24,5 mm - "Self Centering Bearing System" - Grease port Carbon-cover - Alloy fixing bolt
CABLE GUIDE PLATE	AI-00CD ● Stainless steel with QPQ treatment

CHORUS 9 Speed

technical specifications

REAR DERAILLEUR	RD-19CH ● 9 Speed - Anodized - maximum sprocket: 26 teeth - Capacity: 27 teeth
FRONT DERAILLEUR	For double crankset - Capacity: 15 teeth - Max. chainring: 54 teeth
	FD-21SCH ● Braze-on - Anodized
	FD-11FCH ○ Clip-on Ø 28,6 mm - Anodized
	FD-12FCH ○ Clip-on Ø 32 mm - Anodized
	FD-03FCH ○ Clip-on Ø 35 mm - Anodized
ERGOPOWER	EC-19CHCG ● Carbonfibre body - Ball bearings - Triple compatible - Compensation spring - Anodized levers Incl. cables and prelubricated casings - No brake housing ferrules
SHIFTING LEVERS	SL-09SRECG ○ 9 Speed - Down tube - Indexed
FRONT HUB	HB-20CH ● O.L.D.: 100 mm - Spoke holes: 32/36 - Sealed dust cup - QR with aluminium lock nut
REAR HUB	FH-19CH ● O.L.D.: 130 mm - 9 Speed aluminium freewheel body - Spoke holes: 32/36 - QR with aluminium lock nut
CASSETTES	CS-19SP ● 9 Speed Exa-Drive MK2 - Steel - Nickel-chromed - With light alloy carrier - Combinations: 12/21 - 12/23 - 13/23 - 13/26
	CS-19RETI ○ 9 Speed Exa-Drive MK2 - Titanium - With light alloy carrier - Combinations: 12/21 - 12/23 - 13/23 - 13/26
CHAIN	CN-19RE ● 9 Speed - "Floating Link Action" - Nickel-Teflon finish - 114 links - 8 Speed compatible
CRANKSET	FC-21CH ● Low-profile cranks: L. 170 - 172,5 - 175 mm - Anodized - Exa-Drive chainrings: 39 x 52 - 42 x 52 - 39 x 53 - 42 x 53

● = Standard component ○ = Optional component

BOTTOM BRACKET	Sealed cartridge - Symmetrical allow axle - Italian 36 x 24 tpi - English BC 1,370 x 24 tpi - Aluminium cups
	BB-01CHCART ● For double crankset - Axle L 102 - IT thread
	BB-03CHCART ○ For double crankset - Axle L 102 - BC thread
PEDALS	PD-42CHQR ● QR - PRO-FIT - With floatings cleats - Thread: 9/16" x 24 tpi - Adjustable cones and cups Adjustable release tension
BRAKES	BR-52CH ● Dual-Pivot - Height 39±50 mm - Stainless steels ball bearings - Anodized
BRAKE LEVERS	BL-22RECG ○ Anodized
SEATPOST	SP-20RE ● With screw and locking nut - 250 mm - Steel tube - Light alloy head - Ø 25 / 27,2
HEADSET	HS-21CH ● Thread BC 1" x 24 tpi - Balls Ø 3,96 mm (upper) and 4,76 mm (lower) Overall stack height: 36,5 (top 24 mm - bottom 12,5 mm) - Anodized
	HS-01CHHD ○ For unthreaded steerers Ø 1" (25,4mm) - Height: 24,5 mm - "Self Centering Bearing System"
CABLE GUIDE PLATE	AI-00CD ● Stainless steel with QPQ treatment

ATHENA 9 Speed

technical specifications

REAR DERAILLEUR	RD-09AT ● 9 Speed - Anodized - maximum sprocket: 26 teeth - Capacity: 27 teeth
TRIPLE DERAILLEUR	RD-09RA3 ○ 9 Speed - Anodized - maximum sprocket: 28 teeth - Capacity: 37 teeth
FRONT DERAILLEUR	For double crankset - Capacity: 15 teeth - Max. chainring: 54 teeth
	FD-21SCH ● Braze-on - Anodized
	FD-11FCH ○ Clip-on Ø 28,6 mm - Anodized
	FD-12FCH ○ Clip-on Ø 32 mm - Anodized
	FD-03FCH ○ Clip-on Ø 35 mm - Anodized
TRIPLE FRONT DERAILLEUR	For triple crankset - Capacity: 22 teeth - Max. chainring: 52 teeth
	FD-11SRA3 ○ Braze-on - Anodized
	FD-11FRA3 ○ Clip-on Ø 28,6 mm - Anodized
	FD-12FRA3 ○ Clip-on Ø 32 mm - Anodized
	FD-13FRA3 ○ Clip-on Ø 35 mm - Anodized
ERGOPOWER	EC-09ATCG ● Carbonfibre body - Triple compatible - Compensation spring - Anodized levers Incl. cables and prelubricated casings - No brake housing ferrules
FRONT HUB	HB-50AT ● O.L.D.: 100 mm - Spoke holes: 28/32/36 - Sealed dust cup - Lateral grease port
REAR HUB	FH-09AT ● O.L.D.: 130 mm - Sealed dust cup - 9 Speed aluminium freewheel body (MK2) - Spoke holes: 28/32/36 - Lateral grease port
CASSETTES	CS-19SP ● 9 Speed Exa-Drive MK2 - Steel - Nickel-chromed - Combinations: 12/21 - 12/23 - 13/23 - 13/26
CHAIN	CN-19RE ● 9 Speed - "Floating Link Action" - Nickel-Teflon finish - 114 links - 8 Speed compatible
CRANKSET	FC-21AT ● Low-profile cranks: L. 170 - 172,5 - 175 mm - Anodized Exa-Drive chainrings: 39 x 52 - 42 x 52 - 39 x 53 - 42 x 53
TRIPLE CRANKSET	FC-11RA3 ○ Low-profile cranks: L. 170 - 175 mm - Anodized Exa-Drive chainrings: 30 x 40 x 50 - 30 x 42 x 52 - 32 x 42 x 52
BOTTOM BRACKET	Sealed cartridge - Symmetrical axle - Italian 36 x 24 tpi - English BC 1,370 x 24 tpi - Recessed aluminium cups
	BB-11ATCART ● For double crankset - For triple for frame with Ø 28,6 mm seat tube - IT thread - Axle L 111
	BB-13ATCART ○ For double crankset - For triple for frame with Ø 28,6 mm seat tube - BC thread - Axle L 111
	BB-11RA3 ○ For triple crankset for frame with Ø 32 or 35 mm seat tube - IT thread - Axle L 115,5
	BB-13RA3 ○ For triple crankset for frame with Ø 32 or 35 mm seat tube - BC thread - Axle L 115,5
PEDALS	PD-52ATQR ● QR - PRO-FIT - With floating cleats - Thread: 9/16" x 24 tpi - Steel axle - 2 bearings Adjustable release tension
BRAKES	BR-42AT ● Dual-Pivot - Height 39±50 mm - Brake pad shoes with orbital adjustment - Anodized
HEADSET	HS-21AT ● Thread BC 1" x 24 tpi - Balls Ø 3,96 mm (upper) e 4,76 mm (lower) Overall stack height 36,5 (top 24 mm - bottom 12,5 mm) - Anodized
CABLE GUIDE PLATE	AI-12CD ● Resin - To fit under bottom bracket shell

VELOCE 9 Speed

technical specifications

REAR DERAILLEUR	RD-21MI	● 9 Speed - Anodized - maximum sprocket: 28 teeth - Capacity: 27 teeth
TRIPLE DERAILLEUR	RD-09VL3	○ 9 Speed - Anodized - maximum sprocket: 28 teeth - Capacity: 37 teeth
FRONT DERAILLEUR	For double crankset - Capacity: 15 teeth - Max. chainring: 54 teeth	
	FD-41SVL	● Braze-on - Anodized
	FD-41FVL	○ Clip-on Ø 28.6 mm - Anodized
	FD-22FVL	○ Clip-on Ø 32 mm - Anodized
	FD-23FVL	○ Clip-on Ø 35 mm - Anodized
TRIPLE FRONT DERAILLEUR	For triple crankset - Capacity: 22 teeth - Max. chainring: 52 teeth	
	FD-21SVL3	○ Braze-on - Anodized
	FD-21FVL3	○ Clip-on Ø 28.6 mm - Anodized
	FD-22FVL3	○ Clip-on Ø 32 mm - Anodized
ERGOPOWER	EC-09VLCG	● Triple compatible - Compensation spring - Anodized levers Incl. cables and prelubricated casings - No brake housing ferrules
FRONT HUB	HB-40VL	● O.L.D.: 100 mm - Spoke holes: 32/36 - Sealed dust cup - Lateral grease port
REAR HUB	FH-09VL	● O.L.D.: 130 mm - Sealed dust cup - 9 Speed aluminium freewheel body - Spoke holes: 32/36 Sealed dust cup - Lateral grease port
CASSETTES	CS-09SP	● 9 Speed Exa-Drive - Steel - Nickel-chromed - Combinations: 12/21 - 12/23 - 13/23 - 13/26
CHAIN	CN-09VL	● 9 Speed - "Floating Link Action" - 114 links - Burnished inner links and rollers - 8 Speed compatible
CRANKSET	FC-31VL	● Low-profile cranks: L. 170 - 172.5 - 175 mm - Anodized Exa-Drive chainrings: 39 x 52 - 42 x 52 - 39 x 53
TRIPLE CRANKSET	FC-21VL3	○ Low-profile cranks: L. 170 - 172.5 - 175 mm - Anodized Exa-Drive chainrings: 30 x 40 x 50 - 30 x 42 x 52 - 32 x 42 x 52
BOTTOM BRACKET	Sealed cartridge - Symmetrical axle - Aluminium cups - Italian 36 x 24 tpi - English BC 1,370 x 24 tpi	
	BB-11VLCART	● For double crankset - For triple for frame with Ø 28.6 mm seat tube - IT thread - Axle L. 111
	BB-13VLCART	○ For double crankset - For triple for frame with Ø 28.6 mm seat tube - BC thread - Axle L. 111
	BB-11RA3	○ For triple crankset for frame with Ø 32 or 35 mm seat tube - IT thread - Axle L. 115.5
	BB-13RA3	○ For triple crankset for frame with Ø 32 or 35 mm seat tube - BC thread - Axle L. 115.5
BRAKES	BR-32VL	● Dual Pivot - Height 39+50 mm - Anodized
HEADSET	HS-21VL	● Thread BC 1" x 24 tpi - Balls Ø 3/16" - Overall stack height 40.5mm (top 25 mm - bottom 15.5 mm) - Anodized
CABLE GUIDE PLATE	AI-12CD	● Resin - To fit under bottom bracket shell
PEDALS	PD-52ATQR	○ QR - PRO-FIT - With floating cleats - Thread: 9/16" x 24 tpi - Steel axle - 2 bearings - Adjustable release tension

MIRAGE 8 Speed

technical specifications

REAR DERAILLEUR	RD-21MI	● 8 Speed - Anodized - maximum sprocket: 28 teeth - Capacity: 26 teeth
TRIPLE DERAILLEUR	RD-13MI	○ 8 Speed - Anodized - maximum sprocket: 28 teeth - Capacity: 37 teeth
FRONT DERAILLEUR	For double crankset - Capacity: 15 teeth - Max. chainring: 54 teeth	
	FD-41SVL	● Braze-on - Anodized
	FD-41FVL	○ Clip-on Ø 28.6 mm - Anodized
	FD-22FVL	○ Clip-on Ø 32 mm - Anodized
	FD-23FVL	○ Clip-on Ø 35 mm - Anodized
TRIPLE FRONT DERAILLEUR	For triple crankset - Capacity: 22 teeth - Max. chainring: 52 teeth	
	FD-21SVL3	○ Braze-on - Anodized
	FD-21FVL3	○ Clip-on Ø 28.6 mm - Anodized
	FD-22FVL3	○ Clip-on Ø 32 mm - Anodized
ERGOPOWER	EC-08MICG	● Triple compatible - Compensation spring - Anodized levers - With cables and casings - No brake housing ferrules
FRONT HUB	HB-30MI	● O.L.D.: 100 mm - Spoke holes: 32/36 - Sealed dust cup - Sealed bearings
REAR HUB	FH-20MI	● O.L.D.: 130 mm - 8 Speed steel freewheel body - Spoke holes: 32/36 - Sealed dust cup - Sealed bearings
CASSETTES	CS-08SP	● 8 Speed Exa-Drive - Steel - Galvanized finish - Combinations: 12/23 - 12/25 - 13/23 - 13/26 - 14/26 - 16/23

● = Standard component

○ = Optional component

CHAIN	CN-11AT	● Black finish- 114 links - Riveted pentagonal pin
CRANKSET	FC-21MI	● Low-profile cranks: L. 170 - 172.5 - 175 mm - Anodized Exa-Drive chainrings: 39 x 53 - 42 x 52
TRIPLE CRANKSET	FC-21MI3	○ Low-profile cranks: L. 170 - 175 mm - Anodized Exa-Drive chainrings: 30 x 40 x 50 - 32 x 42 x 52
BOTTOM BRACKET	Sealed cartridge - Symmetrical axle - Steel cups - Italian 36 x 24 tpi - English BC 1,370 x 24 tpi	
	BB-11MI CART	● For double crankset - For triple for frame with Ø 28.6 mm seat tube - IT thread - Axle L. 111
	BB-13MI CART	○ For double crankset - For triple for frame with Ø 28.6 mm seat tube - BC thread - Axle L. 111
	BB-11MI3	○ For triple crankset for frame with Ø 32 or 35 mm seat tube - IT thread - Axle L. 115.5
	BB-13MI3	○ For triple crankset for frame with Ø 32 or 35 mm seat tube - BC thread - Axle L. 115.5
BRAKES	BR-22MI	● Dual-Pivot - Height 39+50 mm - Anodized
HEADSET	HS-11MI	● Thread BC 1" x 24 tpi - Balls Ø 3/16" - Overall stack height 40.5mm (top 25 mm - bottom 15.5 mm) - Anodized
CABLE GUIDE PLATE	AI-12CD	● Resin - To fit under bottom bracket shell
PEDALS	PD-52ATQR	○ QR - PRO-FIT - With floating cleats - Thread: 9/16" x 24 tpi - Steel axle - 2 bearings - Adjustable release tension

AVANTI 8 Speed

technical specifications

REAR DERAILLEUR	RD-21AV	● 8 Speed - Anodized - maximum sprocket: 28 teeth - Capacity: 26 teeth
TRIPLE DERAILLEUR	RD-13AV	○ 8 Speed - Anodized - maximum sprocket: 28 teeth - Capacity: 37 teeth
FRONT DERAILLEUR	For double crankset - Capacity: 15 teeth - Max. chainring: 54 teeth	
	FD-21SAV	● Braze-on - Anodized
	FD-21FAV	○ Clip-on Ø 28.6 mm - Anodized
TRIPLE FRONT DERAILLEUR	For triple crankset - Capacity: 22 teeth - Max. chainring: 52 teeth	
	FD-11SAV3	○ Braze-on - Anodized
	FD-11FAV3	○ Clip-on Ø 28.6 mm - Anodized
ERGOPOWER	EC-08AVCG	● Triple compatible - Compensation spring - Anodized brake levers - With cables and casings No brake housing ferrules
FRONT HUB	HB-00AV	● O.L.D.: 100 mm - Spoke holes: 32/36 - Sealed dust cup - Sealed bearings
REAR HUB	FH-20AV	● O.L.D.: 130 mm - 8 Speed steel freewheel body - Spoke holes: 32/36 - Sealed dust cup - Sealed bearings
CASSETTES	CS-08SP	● 8 Speed Exa-Drive - Steel - Galvanized finish - Combinations: 12/23 - 12/25 - 13/23 - 13/26 - 14/26 - 16/23
CHAIN	CN-01AV	● Black finish- 114 links - Riveted pentagonal pin
CRANKSET	FC-21AV	● Low-profile cranks: L. 170 mm - Anodized Exa-Drive chainrings: 39 x 52 - 42 x 52
TRIPLE CRANKSET	FC-21MI3	○ Low-profile cranks: L. 170 - 175 mm - Anodized Exa-Drive chainrings: 30 x 40 x 50 - 32 x 42 x 52
BOTTOM BRACKET	Sealed cartridge - Symmetrical axle - Steel cups - Italian 36 x 24 tpi - English BC 1,370 x 24 tpi	
	BB-11MI CART	● For double crankset - For triple for frame with Ø 28.6 mm seat tube - IT thread - Axle L. 111
	BB-13MI CART	○ For double crankset - For triple for frame with Ø 28.6 mm seat tube - BC thread - Axle L. 111
	BB-01MI3	○ For triple crankset for frame with Ø 32 or 35 mm seat tube - IT thread - Axle L. 115.5
	BB-03MI3	○ For triple crankset for frame with Ø 32 or 35 mm seat tube - BC thread - Axle L. 115.5
BRAKES	BR-22AV	● Dual-Pivot - Height 39+50 mm - Anodized
CABLE GUIDE PLATE	AI-12CD	● Resin - To fit under bottom bracket shell

Campagnolo cannot guarantee the superior performance and function of its 9 Speed system, unless all the components making up the drive-set are used in conjunction. These components were specifically designed to be interfaced and complemented with each other. Don't settle for anything but the best!



service CENTER

BELGIUM

SIMONS NV
Staatsbaan 279 - 3260 BEKKEVOORT
Phone +32-1-6632095 - Fax +32-1-6632840

BIKETEK NV
Gentweg 78 - 9890 GAVERE
Phone +32-9-3845111 - Fax +32-9-3844914

HOLLAND

CARD BENELUX
Nispensestraat 72 - 4701 CX ROOSENDAAL
Phone +31-1-65564241 - Fax +31-1-65563248

FA WOUT VERHOEVEN
Rodenrijseweg 409 - 2651 AM BERKEL EN RODENRIJS
Phone +31-10-5115014 - Fax +31-10-5117708

DENMARK

AAGE KROLL A/S
Jydækroggen 18 - 2625 VALLENSBAEK
Phone +45-43-660066 - Fax +45-43-660099

GREAT BRITAIN

MERCIAN CYCLES LT.
7, Shardlow Road - ALVASTON - DERBY - DE2 0JG
Phone +44-1332-752468 - Fax +44-1332-751033

SWITZERLAND

PIERO ZURINO AG
Frauenfelderstraße 20 - 9542 MUENCHWILEN TG
Phone +41-719-666722 - Fax +41-719-666690

AUSTRALIA

BIKE SPORTZ
11, MACBETH Street - BRAESIDE - VICTORIA 3195
Phone +61-3-95872344 - Fax +61-3-95876951

CONTINENTAL BICYCLE TYRES
P.O. Box 42 - 44 Bronte Road - BONDI JUNCTION NSW 2022
Phone +61-2-3694761 - Fax +61-2-3892662

CANADA

CYCLES MARINONI INC
1067, Lavis - LACHENAIE - QUEBEC J6W 4L2
Phone +15-144717133 - Fax +15-144719887

GREAT WESTERN BICYCLE COMPANY LTD.
233, West Broadway - VANCOUVER, BC V5Y 1P5
Phone +16-048722424 - Fax +16-0487202226

ITALY

CAMPAGNOLO S.R.L.
Via della Chimica, 4 - 36100 Vicenza
Phone +39-444-225600 - Fax +39-444-225400

JAPAN

KAWASHIMA CYCLE SUPPLY CO
N. 4-2-4, Kushiya-Cho - 590 OSAKA
Phone +81-722-386126 - Fax +81-722-214379

NEW ZELAND

W.H. WORRALL & CO. LTD.
P.O. Box 8381 - Symonds street - AUCKLAND
Phone +64-96303901 - Fax +64-963303839

GERMANY

CAMPAGNOLO DEUTSCHLAND GMBH
Schusterinsel 15 - 51379 Leverkusen
Phone +49-2171-72430 - Fax +49-2171-724315

FRANCE

CAMPAGNOLO FRANCE S.A.R.L.
3, Rue du 8 Mai - 42160 ANDREZIEUX - BOUTHEON
Phone +33-477-556305 - Fax +39-477-556345

SPAIN*

CAMPAGNOLO IBERICA S.L.
Pintor Jesus Apellaniz, 17 - 01008 VITORIA
Phone +34-(9)-45-222504 - Fax +34-(9)-45-244007
*Starting from 1st January 1998

USA

CAMPAGNOLO USA INC.
545th. Av. Ebcinas - CARLSBAD - CA 92008
Phone +1-760-9310109 - Fax +1-760-9310991



in the WEB



<http://www.campagnolo.com>



in the
WORLD

CAMPAGNOLO

CAMPAGNOLO S.R.L.

Via della Chimica, 4 · 36100 Vicenza · ITALY
Phone: +39-444-225500
Fax: +39-444-225400
Website: <http://www.campagnolo.com>
E-mail: campagnolo@campagnolo.com

CAMPAGNOLO GMBH

Schusterinsel 15 · 51379 Leverkusen · GERMANY
Phone: +49-2171-72430
Fax: +49-2171-724315

CAMPAGNOLO FRANCE SARL

B.P. 148 · 42163 Andrieux
Boutheon Cedex · FRANCE
Phone: +33-477-556305
Fax: +33-477-556345

CAMPAGNOLO IBERICA S.L.

Pintor Jesus Apellaniz, 17 · 01008 Vitoria · SPAIN
Phone: +34-(9)-45-222504
Fax: +34-(9)-45-244007

CAMPAGNOLO USA INC.

5451H. Av. Encinas · Carlsbad
CA 92008 · U.S.A.
Phone: +1-760-9310106
Fax: +1-760-9310991

CAMPAGNOLO

LATINO AMERICANA CML LTDA.

Rua Monte Alegre 523 Conj. 51 · Perdizes
São Paulo/SP · CEP: 05014-000 · BRASIL
Phone: 55-11-629010
Fax: 55-11-629010

CAMPAGNOLO ASIA TAIWAN

3F-1, No. 1 Wo-Lung Street
Taipei · TAIWAN R.O.C.
Phone: +886-2-3778059
Fax: +886-2-3778062

AGENCIES

BENELUX:

I.C.C.
P.O. Box 73 · 4527 ZH Aardenburg
NEDERLAND
Phone: +31-117-492820
Fax: +31-117-492835

UNITED KINGDOM:

SELECT CYCLE COMPONENTS
The Old Barn · Chapel Lane · Costock ·
Leicestershire · LE12 6UY · ENGLAND
Phone: +44-1509-854046
Fax: +44-1509-854056

SWEDEN - NORWAY - FINLAND:

ULLBERG & CO AB
Vikdalsgränd 10 A, S-131 40 Nacka, SWEDEN
Phone: +46-8-6011840
Fax: +46-8-7183271

SERVICE AND TECHNICAL INFORMATION:

CENTRAL (ITALY)

Phone: +39-444-225600

GERMANY

Phone: +49-2171-72430

U.S.A.

Phone: +1-760-9310106