

 NORCO

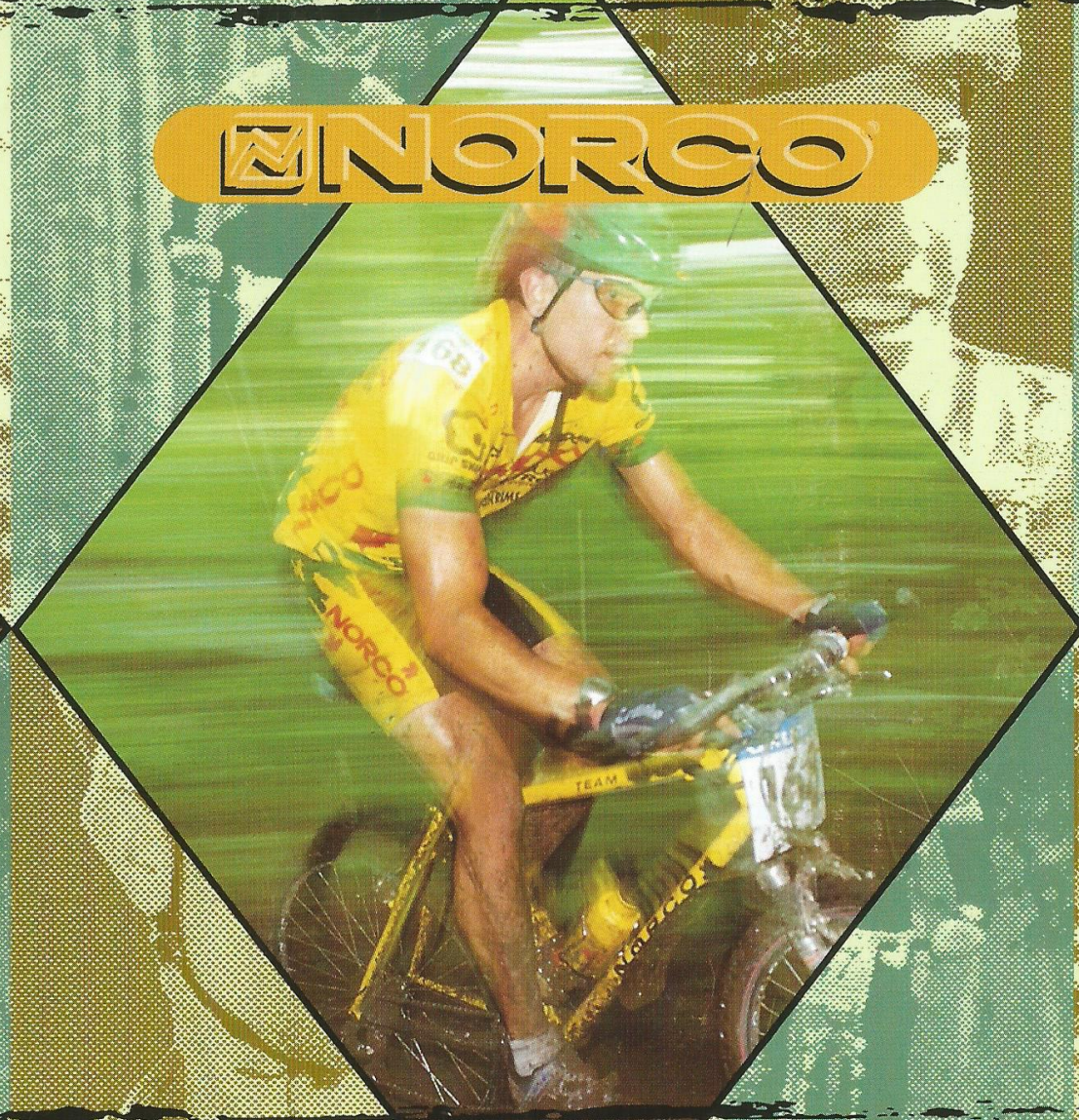

Mountain Bike & Hybrid Series

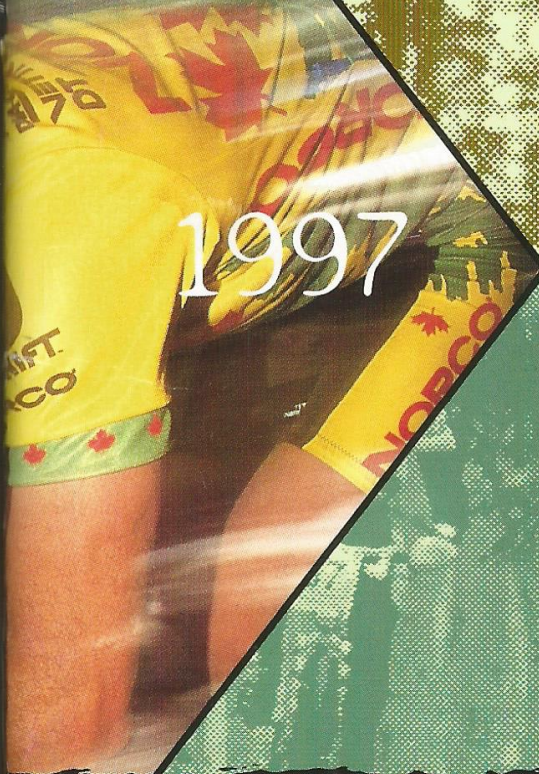

# INTRODUCTION

For over 30 years, Norco has produced bicycles with an unwavering commitment to quality, value and above all performance.

These high standards are maintained by the Norco Pro Team and our R&D staff, who work together testing each bike on some of the world's most aggressive and technically demanding terrain, and refining each design to maximize and match performance with intended use.

**Norco offers more options than ever before.**

If you are looking for the ultimate in traction, control and comfort, our selection of full suspension bikes will exceed your expectations.

If you need a lightweight, hard trail bike that excels in technical single track, consider one of our competition series models.

If you prefer a multi-purpose ride, our hybrid program offers four new models, including two dropbar touring bikes that are ideal for both urban commuting and weekend adventures.

Norco bicycles are only available through professional bike shops which guarantee superior assembly, maintenance and service.

**For a closer look at our 1997 line-up, visit a Norco dealer near you.**

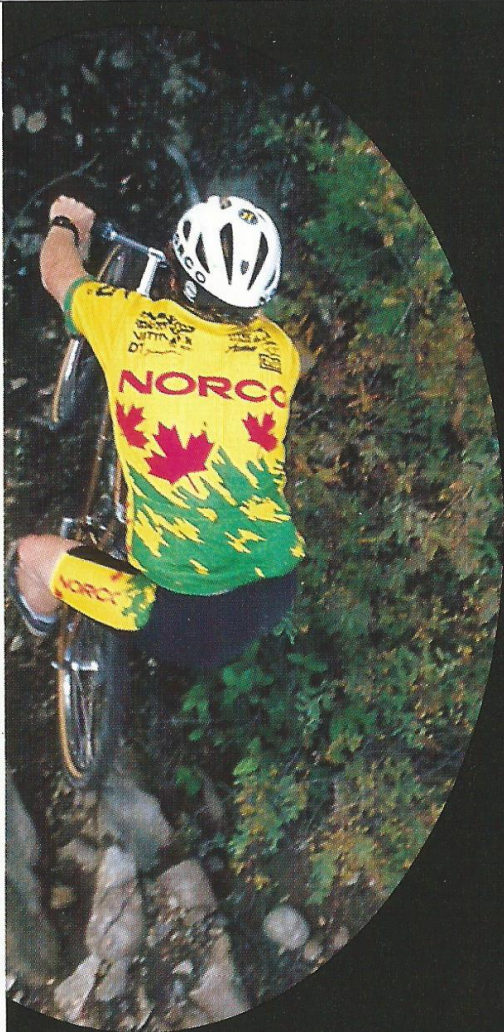



# TEAM ISSUE



*"We've ridden just about every fork out there. None came close to the ride of the Bomber".  
Mountain Biking, July 96'*

**Frame Weight:** 1800 g  
**Weight:** 11.06 kg / 24.55 lbs

- Reynolds 853 main triangle with super light Stoutlight "AFS" Stays and Ritchey Lost Wax dropouts.
- Shimano XTR rear derailleurs, and Gripshift X-Ray shifters with super smooth Gore cables.
  - Race Face LP forged cranks for ultimate strength and stiffness.
  - Titec titanium handlebar and Axiom Pro forged stem. • Exus clipless pedals.
  - Mavic 221 rims with the new Panaracer Duster "BFC" tires, designed to fight off pinch flats.
  - Colour: Brilliant Silver

## Marzocchi Bomber Z-2



- External damping adjustment for easy tuning.
- Speed sensitive valving for predictable compression and rebound.
- Lightweight Easton steer tube.
- 1650 g • 65mm travel

## Magura Hydraulic Lever

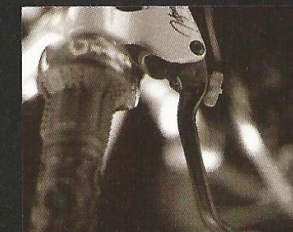

- Tomac Edition Magura hydraulic brakes.
- Improved lever ergonomics.
- Turbo Pad thumb adjuster for easy tuning as brake pads wear.
- Complete with two quick-release units for easy wheel removal.
- Rear booster reduces stay flex and increases stopping power.



# TEAM INFO

## Why do we race?

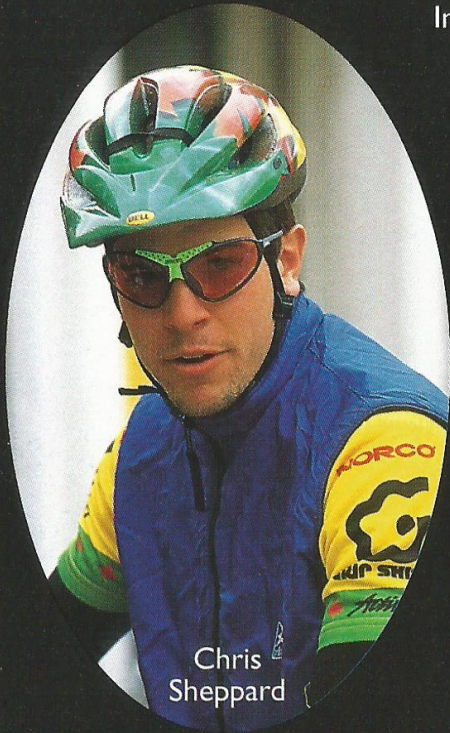

Chris Sheppard

In the fiercely competitive sport of mountain bike racing, there are few lasting design standards. What is commonplace one year can easily be scrap metal the next. By racing, we are better able to design a bike that gives you superior and lasting value.

That's because Norco's 19-member Off Road Team collectively logs an excess of 8,500 km every month during the racing season (April-Sept). This incredible amount of mileage gives our designers the feedback they need to know what works and what doesn't.

Our commitment to MTB racing reaches far beyond our own team. The Norco 1996 Grassroots Racing Program successfully supported many up and coming racers across Canada, while our involvement in nationally sanctioned MTB racing events includes substantial cash and prize donations.

And the final reason for our racing endeavors? We believe that by supporting people who really love what they do - that is, riding a bike really fast - then others will want to join in and see what all the fun is about.

**Before you know it, people will start riding their bikes**

**everywhere - racing on the occasional weekend -**

**with a perma-grin engraved on their faces.**



A handful of our 1997 team members



# BOMBER



**Frame Weight:** 2678 g  
**Weight:** 12.78 kg / 28.15 lbs

## Marzocchi Bomber Z-1



- Dual hydraulic cartridges with mechanical springs for an ultra plush feel.
- Speed sensitive valving for predictable compression and rebound.
- Lightweight Easton steer tube.
- Tortionally rigid arch design with offset bolt pattern.
- 100 mm travel • 1550 g.

## New Oversize Risse Shock



- The larger air volume uses less pressure (AVG 100 PSI), and results in a plush, stiction-free feel.
- Needle valve design allows for easy air pressure adjustments.
- Large piston design resists lateral frame flex.

- Handmade quality from the USA.
- Interrupted/active suspension design. Short shock stay eliminates lateral flex - 4" travel standard, or 6" long travel option.
- Easton double butted downtube eliminates the need for gussets.
- Race Face forged/CNC cranks with XT derailleurs and Gripshift X-Ray shifters.
- Magura HS-22 hydraulic brakes with rear booster.
- Axiom XC clipless pedals.
- Mavic 221 rims and Panaracer Duster Kevlar tires.
- Colour: Bomber Orange



# TUBING

At Norco, we are continually testing and evaluating new materials in an effort to deliver the best balance between performance, durability and weight.



## TANGE CHRO-MOLY

Chro-moly tubing has stood the test of time, and represents an ideal mix of weight, durability and price. Through careful material selection, butting and heat treatment, Tange has successfully engineered tube sets that provide the resilience and ride feel demanded by top pros.



## REYNOLDS 853

In 1996, after three years of research and development, Reynolds introduced a new steel frame material that has taken the cycling world by storm. Reynolds 853 is a high strength air hardened alloy that takes seamless steel to new heights. Unlike current steels, this alloy actually increases in strength in the critical joint areas as it cools from welding. It delivers outstanding fatigue life, damage resistance, and is lightweight, making it ideal for competition. We are pleased to feature 853 on the Rampage and Team Issue.



## EASTON

Easton is unquestionably the world leader in aluminum frame tubing. Easton taperwall tubes have been engineered to be light and strong. Weight reduction and a lively, resilient ride feel has made Easton one of the most popular materials for high performance, competition frame sets.

**Whatever your frame requirements, Norco has you covered.**



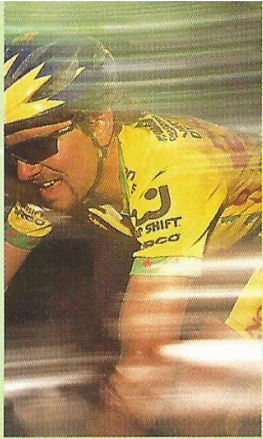

# TORRENT



**Frame Weight:** 1600 g  
**Weight:** 10.96 kg / 24.15 lbs

- Ultra light Easton "Elite" taperwall tubing with "AFS" rear stays.
- Marzocchi Bomber Z-2 suspension fork, 65mm travel.
- Race Face forged cranks with CNC chainrings.
- Shimano XTR rear derailleur and Gripshift X-Ray shifters with Gore cables.
- Axiom XC clipless pedals.
- Mavic 221 rims, Deore XT hubs, Wheelsmith butted spokes, and Panaracer Duster Kevlar tires.
- Colour: Matte Yellow

## Shimano XTR

The name speaks for itself.



- Ball bearing pulleys reduce friction.
- Adjustable guide spring and pulley tension allows fine tuning to terrain conditions and rider preference.
- Teflon-coated link bushings reduce friction and improve reliability.
- Titanium pivot bolt keeps weight to a minimum.

## Magura HS-22 Hydraulic Brakes



- The ultimate in stopping power.
- Features an allen key adjuster for easy pad-to-rim adjustment.
- Two quick releases for easy wheel removal.
- Rear booster reduces stay flex and increases stopping power.



# RAMPAGE

## Rock Shox Judy C



- 80mm long travel version.
- Hydraulic damper provides ultimate compression and rebound control.
- External adjuster knobs for easy trailside performance tuning.
- Stiction free double seal system.
- Lightweight (3.25 lbs).

## Shimano LX 4 Arm Crank



- Ultra stiff arm profile for maximum power transfer.
- Cartridge type chainrings resist lateral flex and offer crisp front shifts.
- Interactive glide tooth profiles and ramps assist in up and down shifts.



Frame Weight: 1820 g  
Weight: 11.30 kg / 24.9 lbs

7

- Reynolds 853 main triangle with butted stays and Ritchey Lost Wax dropouts.
- Gripshift X-Ray shifters with Shimano Deore XT derailleurs.
- Shimano Deore LX V-Brakes with Avid 3.0i levers.
- Axiom clipless pedals.
- Mavic 221 rims, Deore LX hubs, Wheelsmith butted spokes, and Panaracer Duster Kevlar tires.
- Colour: Radiant Black

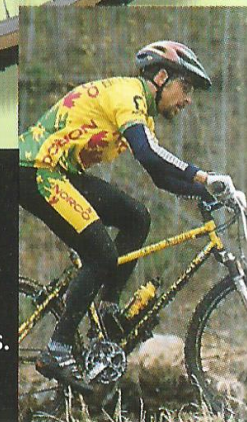



# LOBOS PRO

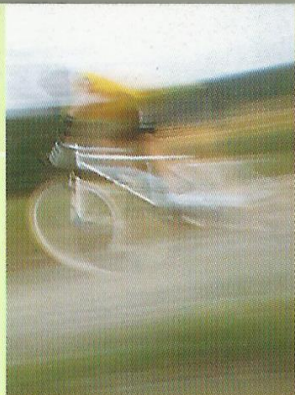

Frame Weight: 2900 g  
Weight: 12.91 kg / 28.45 lbs

- Interrupted/active suspension design with a 3" rear wheel travel and Easton taperwall downtube.
  - Rock Shox Indy XC with 75mm travel.
    - Dynamount coil over shock. Adjustable air pressure and preload.
    - Shimano Deore LX V-Brakes with Avid 2.0I levers.
      - 24-Speed drive train with Gripshift SRT-400 shifters and a Deore XT rear derailleur.
      - Colour: Matte Frost Orange

## Axiom XC Clipless Pedals

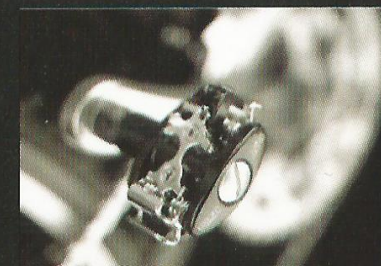

- Ultra compact, lightweight design.
- 318 grams/pr.
- Axiom specific spring for a broader range of entry and release tension.
- Shimano SPD compatible.
- Mud shedding open body design.

## BB Pivot



- Ultra wide triple bearing pivot design resists both twisting and slop.
- Long-wearing PTFE bearings.
- Chro-moly swing arm resists fatigue and improves reliability.
- All components are "off the shelf" for easy maintenance.



# JAVA

## Marzocchi Bomber Z-3



- New variable rate damper controls compression and rebound speed.
- Plush coil spring and MCU spring system.
- Fully adjustable external preload.
- Offset bolt pattern on the arch delivers ultimate in torsional rigidity.
- 1750 g • 65mm travel

## Gripshift/Avid



- Stainless springs for longer life and crisper shifts.
- Delrin parts reduce friction for smooth running internal components and effortless shifts.
- Avid 2.01 levers offer a refined design with the cable travel and mechanical advantage to maximize your V-Brake performance.



Frame Weight: 1650 g  
Weight: 11.07 kg / 25.4 lbs

- Easton Elan 3 taperwall aluminum tubing with "AFS" stays.
- Replaceable derailleur hanger.
- Sugino Impel 350 cranks with an alloy outer ring and 20 tooth granny.
- Shimano Deore LX V-Brakes.
- Mavic 238 rims, Wheelsmith spokes, Deore LX hubs and Panaracer Duster tires.
- Colour: Ball Burnished Silver

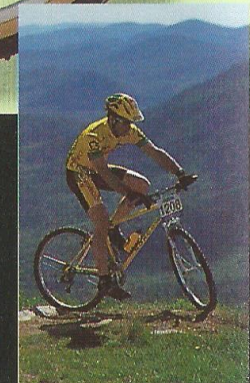



# NITRO

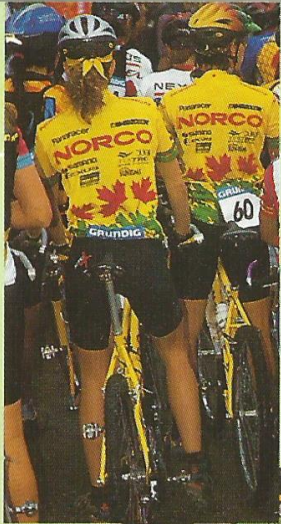

Frame Weight: 2100 g  
Weight: 11.53 kg / 24.4 lbs

- Super tough and lightweight Tange Prestige and MTB double butted tube set.
- Shimano Deore XT rear derailleurs with "LX" Rapidfire plus shifters.
- Shimano fully adjustable BL-M600 brake levers with "LX" V-brakes.
  - Sugino Impel 350 cranks with an alloy outer ring and a 20 tooth granny.
  - Sun CR-18 Double Wall rims, WheelSmith spokes, Deore LX hubs, and Wilderness Trail Velociraptor tires.
  - Colour: Deep Blue Sea

## Rock Shox Indy XC

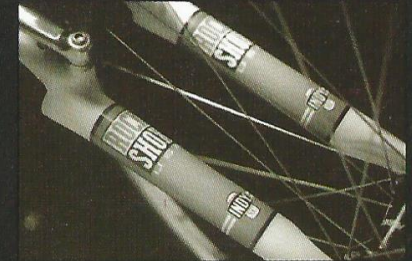

- Tortionally rigid one piece magnesium lower tube assembly.
- Mechanical spring and MCU combination.
- External preload adjusters for easy tuning
- Stiction-free double seal system
- 75mm travel • 3.1 lbs

## Shimano Deore LX Rapidfire Plus Levers



- Independent clamp design provides flexibility in setup positions.
- Short stroke, light action, ultra crisp shifting.
- Stainless steel shift cable resists corrosion.



# LOBOS COMP

## Axiom Threadless Stem



- 6061 T6 heat treated aluminum stem.
- Proven strength, rigidity and fatigue life.

## 30mm Rise Bar

- Extra wide 650mm for added control.
- Moderate rise for a more upright position.

## Dynamount Shock



- Coil over shock with adjustable hydraulic damping.
- Oversize shaft resists lateral frame flex.
- Adjustable spring preload with collar and lock nut.
- Air pressure adjustment with easy-to-access needle valve for custom tuning.
- One year warranty.



Frame Weight: 2950 g  
Weight: 12.98 kg / 28.6 lbs

- Interrupted/active suspension design, with 3" of rear wheel travel.
- Rock Shox Indy C with 63mm travel.
- Shimano Deore LXV-brakes for ultimate stopping power.
- Shimano Deore LX rear derailleur.
- SR cranks with fully interchangeable rings.
- Araya rims, stainless spokes, and Panaracer Duster tires.
- Colour: Radiant Moss

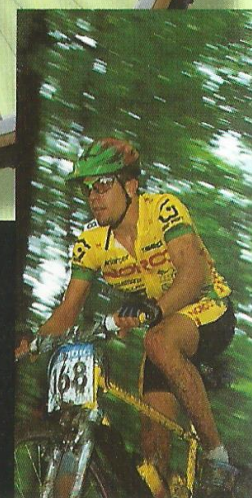



# MOCHA

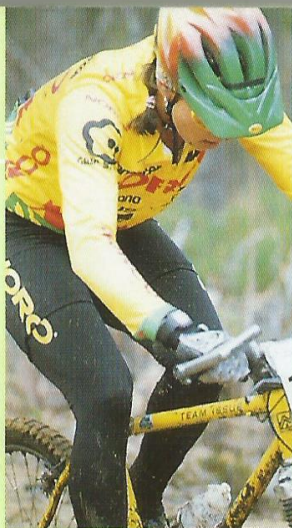

Frame Weight 1725 g  
Weight 11.21 kg / 25.2 lbs

- Easton Reaction tube set with “AFS” stays and replaceable derailleur hanger.
- Rock Shox Indy C suspension fork with 63mm travel.
  - 24-Speed drive train with a Shimano Deore XT rear changer and Sugino cranks.
  - Shimano Deore LX V-brakes with Avid 1.9l levers.
    - Sun Double Wall rims, Wheelsmith spokes, and Wilderness Trail Velociraptor tires.
    - Colour: Ball Burnished Silver

## “AFS” Stays



- Rectangular “AFS” stays resist lateral flex and brake stud deflection associated with today’s powerful long arm cantilevers, V-brakes and hydraulics.
- More than 15% stiffer than standard stays for substantially more powerful braking.

## Sachs Power Grip “Wavy”



- Special Servo spring keeps shift forces low.
- New aggressive grip design eliminates slipping.
- Friction front for fine tuning derailleur position.



# SASQUATCH

## Rock Shox Indy C



- Ultra plush coil spring and elastomer combination results in improved spring curve and a more lively feel.
- Tortionally rigid one-piece magnesium lower tube assembly.
- Hand adjustable preload dials.
- 63mm travel • 3.25 lbs

## Shimano Deore LX V-Brakes



- Stopping power far beyond standard cantilevers.
- Easy set-up and tuning.
- Linear spring provides a light feel at the lever.
- Inset pad mounting reduces stud flex and results in more powerful braking.



Frame Weight: 2150 g  
Weight: 11.75 kg / 25.91 lbs

- Tange MTB double butted chro-moly frame with reduced diameter tubes for weight reduction.
- 24-Speed drive train with Rapid Fire Plus shifters and a Deore XT rear changer.
- Axiom handlebars, stem and seatpost. • Selle Italia Tieffe saddle.
- Araya TM-820 Double Wall rims, stainless spokes, Shimano STX RC hubs and Panaracer Duster tires. • Colour: Burnt Copper

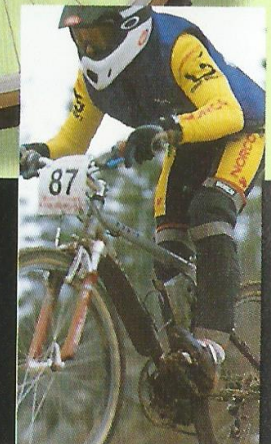



# TANGO



- Active/linkage suspension design with a 2.75" rear wheel travel.
- Lightweight aluminum front triangle with alloy shock stays.
- Dynamount shock with adjustable air pressure and spring preload.
- Rock Shox Quadra Suspension Fork with 48mm travel.
- Shimano Deore LX rear changer and Gripshift shifters.
- Powerful Shimano cantilevers with Tektro levers.
- Rise bar with Axiom threadless stem.
- Colour: Matte Yellow

## Active Linkage Suspension

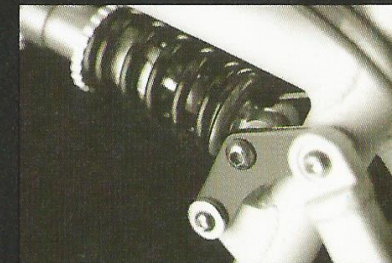

- Suspension stays active whether in or out of the saddle resulting in improved traction, control and comfort.
- Linkage plates minimize lateral frame flex and eliminate stress on the shock.

## Shimano Deore LX Rear Changer



- Light action spring design and teflon-coated pin bushings ensure a light, low-effort shifting action.
- A design that stands the test of time and delivers bullet proof reliability and crisp shifting performance.



# MAGNUM

## Marzocchi Zokes Suspension Fork

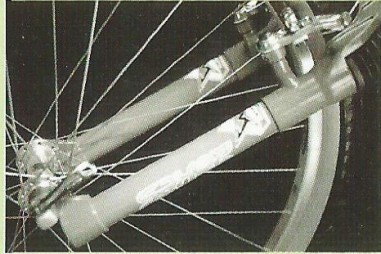

- Tortionally rigid one piece lower leg design delivers superior control and handling.
- Plush feeling multi-stack elastomer spring system.
- Allen key preload adjusters for easy fork tuning.
- 1440 g • 52mm travel.

## Replaceable Rear Derailleur Hanger



- Designed to breakaway in the result of an accident, such as a crash or stick jamming your drive train.
- Saves on an expensive frame repair or replacement.



- Oversize aluminum frame with "AFS" stays and a replaceable rear derailleur hanger.
- 24-Speed drive train with a Shimano Deore LX rear changer and Gripshift SRT-400 shifters.
- Powerful Shimano cantilevers with Alivio levers.
- Axiom comp threadless stem with aluminum bars.
- Sun Double Wall rims with Panaracer Smoke/Dart tires. • Colour: Satin Silver







# BIGFOOT



619.99

- A lightweight performance bike at home on or off road.
- Chromoly double-butted frame with dual tapered "AFS" stays and super tough chromoly forks.
  - 24-Speed drive train with Shimano LX rear changer, Gripshift SRT 400 shifters and Sugino Impel 250 cranks.
  - Ultra powerful Shimano Alivio cantilever brakes and levers.
    - Tough Sun Double Wall rims, with stainless steel spokes and Panaracer Smoke/Dart tires.
    - Selle Italia Tieffe racing saddle.
- Colour: Matte Red

## Duegi Dinicta Cycling Shoes

A premium performance line of hand-made European off-road cycling shoes.

### Axiom AX-100



- Lace/velcro® closure for secure fit.
- Deep heel box for comfort.
- Dinicta premium sole with removable traction studs.

### Dinicta Georgia

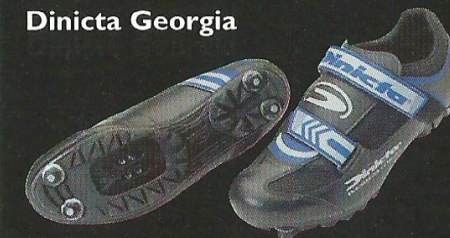

- Natural leather upper.
- Dual opposing velcro® straps for secure and even closure.
- Deep heel box for comfort.
- Dinicta premium sole with removable traction studs.



# BERRETTA

## BLT Spectrum Series



- Anodized CNC alloy body.
- High powered MR-11 halogen bulbs.
- Fully quick-release system.
- Less than 100 g per headlight unit.
- Rechargeable SLA battery (NiCad optional).

## BLT QB Series



- Sealed, focusable headlight units.
- Fully quick-release system.
- LED "Gas Gauge" option.
- Easily accessible on/off switches.
- Rechargeable SLA battery.



- New for 1997 the Berretta features a plush, comfort enhancing suspension fork.
- Chro-moly main tubes and stays with an RST 171B suspension fork featuring elastomer springs for 2" of front wheel travel.
- Shimano cantilever brakes and Tektro levers provide ultimate stopping power.
- Aggressive Bear Trac and Bear Claw tires provide flawless traction off road.
- Colour: Radiant Black

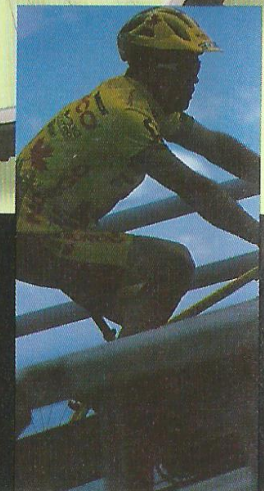



# KOKANEE

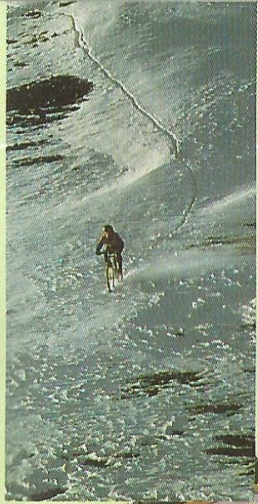

469.99

- Look no further, the Kokanee delivers superior performance, easy handling and reliability.
  - Lightweight frame features chro-moly main tubes, stays and forks.
  - New vertical rear dropouts for convenient rear wheel removal and replacement.
  - Shimano STX Rapidfire shifters and rear changer deliver flawless shifting performance.
  - Stop on a dime with Shimano cantilever brakes and levers.
  - Cranks feature removable rings for easy maintenance or repair.
- Colours: Vibrant Black, Matte Copper

18

## Zen Downhill Glove



- Durable Clarino leather palm.
- Soft, protective Thermoweld padding.
- Lycra® finger side panels for better flexibility.

## Activa Stormfront Jacket



- New "Ultrex" waterproof/breathable fabric.
- Specially cut for cycling, ventilation and reflectivity.



# BUSH PILOT

## Axiom Upgrade Components

- High-grade alloy component upgrades designed to reduce weight without compromising strength and durability.

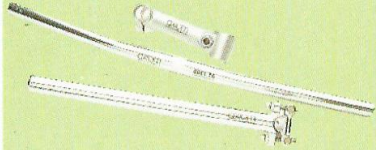

- Premium titanium upgrade components for unsurpassed strength-to-weight ratio.



419.99

19

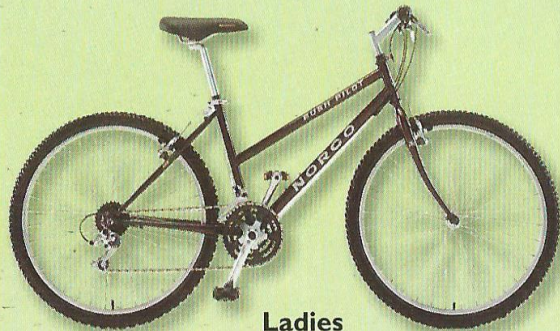

Ladies

- Lightweight frame design features chro-moly main tubes and forks (M&L designs available).
- Responsive Gripshift shifters with a Shimano Alivio rear changer.
- Sugino Genesis cranks and reliable cartridge bottom bracket.
- Comfortable, super soft foam saddle with an alloy micro-adjustable seat post.
- Powerful Shimano cantilever brakes with Tektro three finger levers.
- Aggressive tread Bear Trac and Bear Claw tires.
- Colours: Burnt Burgundy, Bright Silver/Grey, Matte Red



# KATMANDU

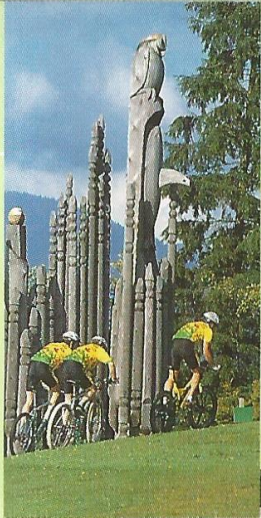

- Introducing the perfect mix of performance and affordability.
  - Sleek, clean frame design with a rugged, outer-buttressed seat tube and an oversized chromoly down tube.
  - Reliable Shimano drive train with an Acera rear derailleur, Hyperglide cogs and Gripshift shifters.
  - Quick-release front and rear wheels for easy transport and maintenance.
  - Tektro levers and aluminum cantilevers provide reliable and responsive braking.
  - Super soft foam saddle delivers added comfort.
- Colours: Satin Silver, Jewel Green

20

## Axiom "T-handle" Rocket Pump



- Precision extruded alloy barrel.
- Kraton ergonomic "T" handle.
- Thumb lock adapter with Presta Schraeder valve.
- Handle locks with a small bungee
- Complete with braze-on mounts.
- Weight: 168 g

## Norco "Nitro" Helmet with visor



- 8 vent micro shell.
- Helmet retention system ensures snug fit.
- High impact EPS liner.
- CSA & ASTM safety approved.
- Made in Canada.



# MOUNTAINEER SL

## Axiom M-13 Multi Tool

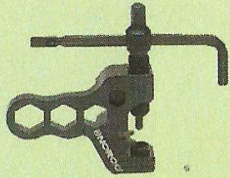

- CNC machined 6061-T6 alloy with chro-moly bits.
- 13 useful tools for almost every minor repair.
- Compact size, weighs only 38 g.



## Norco Compact 9 Multi Tool

- 9 essential tools in one compact size.
- Made of 7075 T-6 alloy with chro-moly bits.
- Weight: 46 g.



319.99

- Rugged frame design with a super oversize 39mm down tube and 34.9mm top tube (M&L designs available).
- 21-Speed Shimano TY-30 wide range gearing will handle all types of terrain.
- "AFS" seat stays and alloy cantilever brakes deliver powerful braking performance.
- Durable Sugino alloy triple cranks.
- Quick-release front wheel for convenient transportation
- Colours: Burgundy/Silver, Silver/Glacier, Yellow



Ladies



# CHEROKEE

279.99



- Feature and value packed.

- Durable oversize mountain bike frame, with "AFS" stays and a sloping top tube for added stand over clearance.
- Crisp-shifting Gripshift shifters with Shimano derailleurs and triple front cranks.
- Alloy rims combine with cantilever brakes for superior braking response.
- Aggressive tires add traction and braking control.
- Full size range from 15"-22". • Colours: Red/Matte Titanium, Ink Blue/Silver

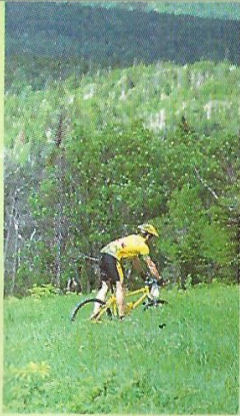

## Norco Tot Taxi Folding Bike Trailer

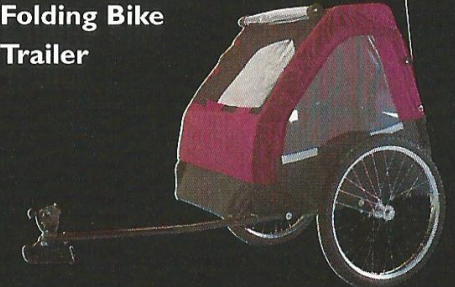

- ABS molded floor with 420DD nylon top.
- Folds flat for easy transportation.
- Safely carries 2 kids facing forward.
- 5 point safety harness, full view windows.
- Chainstay hitch, 20" steel wheels.

## Axiom MTN Cable Lock



- 10mm x 72" steel strand cable with durable vinyl cover.
- Self coiling.
- Integrated key lock with solid brass cylinder.
- Heavy duty resin seat post bracket.

22



# AXIA



- A premium quality bicycle for commuting, touring or weekend adventures.
- Lightweight double-buttressed chromo-moly frame and fork.
- Low rider mounts on the front fork for a front rack.
- Comfort enhancing flex stem and suspension seat post.
- 24-Speed gearing with a Shimano Deore XT rear changer and LX Rapidfire Plus shifters.
- Sugino cranks with a 46-tooth outer ring provide better gearing options for street riding.
- Ultra powerful Shimano Deore LX-V brakes and levers.
- Colour: Ink Blue

23

# AVANTI

- The 1997 Avanti is packed with performance features.
- Sturdy, lightweight hybrid frame design with chromo-moly main tubes and stays.
- 24-Speed C-500 cranks (48-tooth outer ring) and a Shimano Deore XT rear changer.
- Comfort and control is maximized by the flex stem and plush spring saddle.
- Powerful Shimano Alivio cantilever brakes and levers.
- Crisp, short rotation shifts provided by SRT-600 shifters from Gripshift.
- Colour: Anthracite





# MONTREY



559.99

- A reliable, top quality bike for the cyclist that demands performance.
- Lightweight chro-moly hybrid main frame and forks.
- Shimano Deore LX rear changer with precise shifting Gripshift SRT-400 shifters.
- Shimano FC 500 cranks with a 48-tooth outer ring make road riding more efficient.
- Potholes and bumps are smoothed out thanks to the plush saddle with springs.
- Stop with confidence with Shimano Alivio cantilevers and levers.
- Colour: Matte Red

# FIRENZA



469.99

- A new model for 1997 with the fun and function you're looking for.
- Proven hybrid frame design featuring a chro-moly down-tube and sturdy chro-moly forks.
- Shimano Rapidfire shift levers and STX rear changer provide flawless shifting response.
- Reliable cartridge bottom bracket with rugged cold forged cranks.
- Comfortable plush saddle.
- Powerful Shimano cantilever brakes and Alivio levers.
- Colour: Jewel Green



# ARCTIC



- Our best selling hybrid, the Arctic delivers affordable performance and unique style.
- Chro-moly down-tube and fork reduce weight and maximize frame strength.
- Shimano Alivio rear changer and Gripshift 21-Speed shifters.
- Lightweight and durable alloy rims with quick-release front and rear hubs.
- Comfortable upright riding position and super-soft saddle.
- Colour: Pearlized Green

25

# STIKINE

- The lightweight answer for those looking for an alternative to a mountain bike.
- Rugged hybrid frame design available in a choice of four frame sizes.
- Shimano TY-30 21-Speed wide ratio gearing keep you rolling on the flats and flying up the hills.
- The high-rise bar and stem provide a comfortable upright riding position.
- Alloy cantilever brakes for reliable braking response.
- Transportation is made easy thanks to the quick-release front wheel.
- Colour: Burnt Burgundy



369.99





# ALTERES



- A unique blend of road and hybrid components make it ideal for commuting or touring.
- Lightweight chro-moly frame and fork with all the accessories for mounting racks and bottle cages.
- Shimano RSX 21-Speed STI shifter and brake lever combination with a Deore LX rear changer.
- Alloy drop bars with a moderate rise stem for a comfortable, aerodynamic riding position.
- Shimano triple cranks with a 48-tooth outer ring for efficient pedaling on flat and rolling terrain.
- Rugged Araya TX-350 Double Wall rims and smooth rolling 700 x 35C tires.
- Colour: Jewel Green

# TERRENE

26

- A lightweight performance touring bike for the cyclist that demands the best.
  - Premium double-butted chro-moly frame and fork.
  - Low rider rack mounts on the front fork.
  - 24-Speed Shimano 105 STI drive train with a Deore XT rear changer and Sugino Fuse 500 cranks.
  - Powerful Shimano Alivio cantilever brakes.
  - Rugged and reliable wheels with Deore LX hubs and sturdy Araya VX 400 rims.
  - Colour: Matte Red

1139.99





# JUNIOR INTRO

The 1997 Norco Jr. mountain bike line consists of several models with only the premium 20" & 24" wheel being shown in this brochure.

All our Jr. mountain bikes have the same care and quality put into them as our competition and recreation off-road bikes, and they offer a number of similarities including the Norco specific sloping top-tube off-road frame geometry, a TIG welded frame with oversize tubing, and tough name brand components which are tested and proven.

Care is also taken to use only the safest parts. The Jr. series of mountain bikes, is fully loaded with extra safety features, such as the CPSC approved reflector package, derailleur protectors and circular chainguard standard features include Shimano derailleurs, and tough alloy rims for better braking and weight savings. These are just some of the reasons why we guarantee performance and long lasting durability with every Norco bike.

1997 brings new vibrant triple-stage paint colours as well as refinements to components, making the bikes look nicer and ride better while still ensuring the best value. All component parts have been carefully selected to ensure a perfect fit for the smaller rider and a safer, easier-to-ride bicycle.

Norco strongly recommends that all cyclists, especially younger riders, wear safety equipment which includes a helmet and cycling gloves.

# JAMMER

**The jammer is ready to tear out the door and onto the trail!**

The components on this bike are hot and include a SR Duo track fork, with 2" of suspension travel to smooth out the bumps and keep you in control.

A specially designed Norco Jr. MTB frame with oversize tubing and an extra sloping top tube offer added standover and easy handling. Other parts include 18-Speed Gripshift shifters and Shimano derailleurs for easy quick shifts.





# MINI MOUNTAINEER



Boys

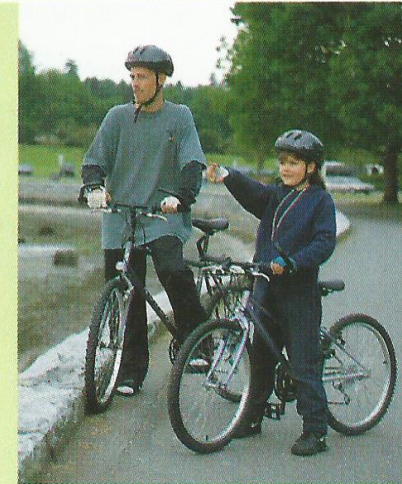

Girls

**Bikes built tough to tackle the trails or whatever else you can dish out.**

The Mini Mountaineer boys and girls are unique bikes because they have all the components and technology used on our adult mountain bikes, but each part is downsized to fit a Jr. rider. Some of the coolest features include junior light alloy brake levers for smaller hands, Jr. bar ends and a smaller cutaway racing saddle. Braking is easy with powerful cantilevers on alloy rims as well as quick shifting with Gripshift 15-speed shifters.



# MICRO MOUNTAINEER



Boys

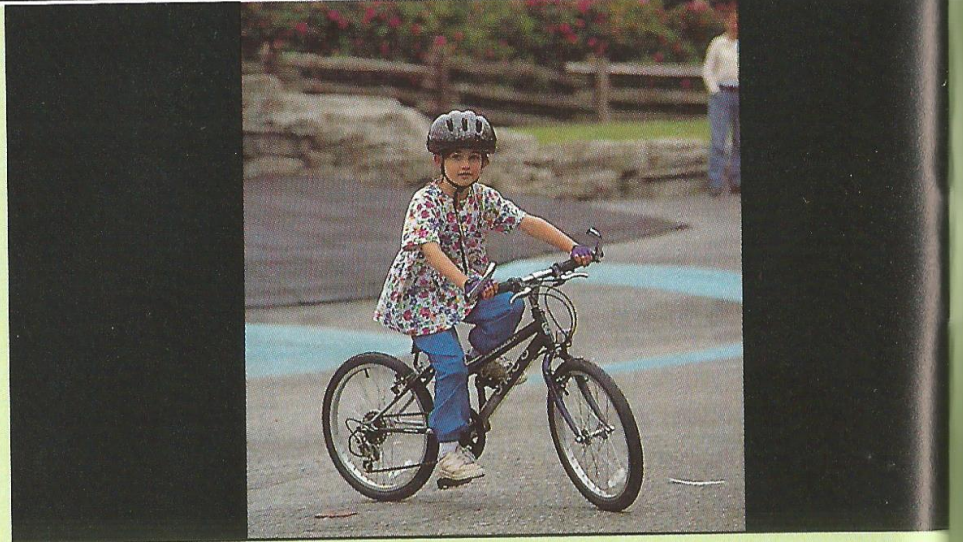

The Micro Mountaineer series include boys and girls frame styles with 20" wheels for riders between the ages of 7 to 11. These 10-speed bikes have Shimano derailleurs, Gripshift shifters, "Smoke-style" off-road knobby tires and powerful cantilever brakes. These features are not usually seen on bikes this size, but are necessary when you demand long lasting quality and safety. If you want to burn ahead of your parents, brother or friends on the trail, the Mini Mountaineer is for you!



Girls



# PROVEN RACE GEOMETRY

## HARD TAILS

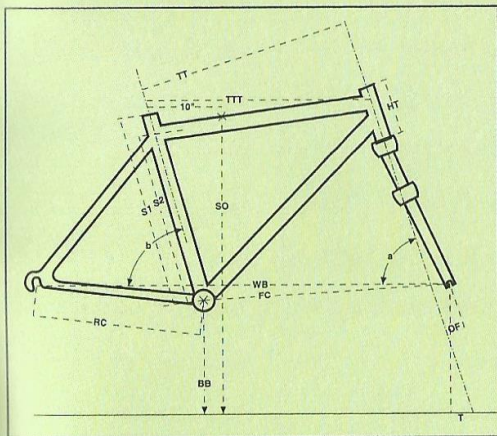

SIZE	S1	S2	SO	TTT	TT	HT	RC	FC	WB	a	b	OF	BB
15"	381	306	685	562	540	100	425	623	1046	70.5°	74°	39	305
17"	435	360	725	565	543	116	425	625	1049	71°	74°	39	305
18.5"	475	400	752	590	564	130	425	641	1064	71°	73°	39	305
20"	510	435	778	612	588	145	425	661	1083	71°	72.5°	39	305
22"	560	485	818	630	610	166	425	680	1104	71°	72.5°	39	305

- S1** Seat Tube (centre-top)
- S2** Seat Tube (centre-centre)
- SO** Standover height (10" in front of TTT & S1 intersection)
- TTT** Theoretical Top Tube

- TT** Top Tube (centre-centre)
- HT** Head Tube
- RC** Chain Stay or Rear Centre
- FC** Front Centre
- WB** Wheelbase

- a** Head Tube angle
- b** Seat Tube angle
- OF** Fork Offset
- BB** Bottom Bracket height

## LOBOS FULL SUSPENSION

SIZE	S1	S2	SO	TTT	TT	HT	RC	FC	WB	a	b	OF	BB
S	457	412	720	560	541	116	430	628	1057	71°	73°	39	320
M	470	425	725	590	565	130	430	648	1077	71°	73°	39	320
L	508	463	735	615	595	155	430	673	1103	71°	73°	39	320

\* Lobos Pro head tube angle 71.5°.  
 • All data based on a 425mm suspension fork.

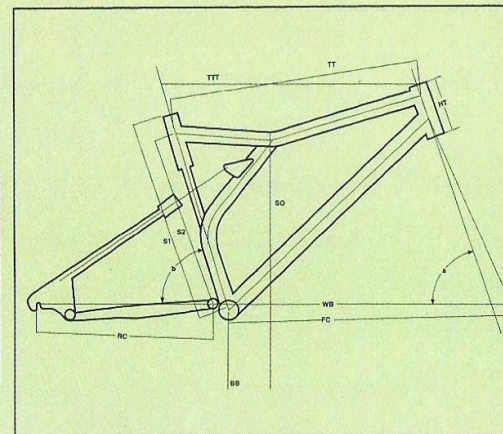

## GEOMETRY

The 1997 line of Norco Bicycles has evolved to reflect the latest in hardtail and full suspension designs. Our designers rely on team rider feedback as well as their own passion for cycling to create designs that will optimize performance and fit for every frame size.

Our hardtail designs have been refined to get the most out of today's longer travel suspension forks. The result is a cross country bike that delivers the handling and control required to tackle the World Cup circuit as well as your favorite local trails.

Our full suspension designs utilize an active suspension system that gives you the same control and performance both in or out of the saddle. The front and rear shocks work in harmony to deliver superior traction and a plush ride.



Model	TEAM ISSUE	BOMBER	TORRENT	RAMPAGE	JAVA	LOBOS PRO	NITRO
Frame	Reynolds 853, Stoutlight Butted Stays, Ritchey Lost Wax Dropouts	Full Suspension, Made in USA, Interrupted Active Easton D/T Risse Shox	Easton Elite Double Butted AFS Rectangular Stays, Replaceable Derailleur Hanger	Reynolds 853, Butted, Tapered Stays, Ritchey Lost Wax Dropouts	Easton Elan 3 Double Butted Tube Set, Replaceable Derailleur Hanger	Full Suspension 3" Travel, Interrupted/Active Design, Easton D/T, L/A Struts	Tange Prestige/MTB, AFS Tapered Chro-moly Stays
Fork	Marzocchi Bomber Z-2 65mm Travel	Marzocchi Bomber Z-1 100mm Travel	Marzocchi Bomber Z-2 65mm Travel	RockShox Judy C 80mm Travel	Marzocchi Bomber Z-3 65mm Travel	RockShox Indy XC 75mm Travel	RockShox Indy XC 80mm Travel
Headset	Tange Cartridge	Tange DX-2 Threadless	Tange DX-2 Threadless	Tange DX-2 Threadless	Tange Threadless	Tange Threadless	Tange Threadless
Cranks	Race Face Forged/CNC	Race Face Forged/CNC	Race Face Forged/CNC	Shimano Deore LX 4-Arm	Sugino Impel 350	Sugino Impel 350	Sugino Impel 350
Bottom Bracket	Shimano UN-72	Shimano UN-52	Shimano UN-72	Shimano UN-52	Shimano UN-52	Shimano LP-26	Shimano LP-26
Pedals	Exus Clipless	Axiom Clipless	Sachs SC-40	Axiom Clipless	Axiom Clipless	Axiom Clipless	Axiom Clipless
Chain	Sachs SC-40	Shimano IG-70	Shimano IG-70	Shimano IG-70	Sachs SC-40	Sachs SC-40	Sachs SC-40
Freewheel	Shimano HG-70 11-30T	Shimano HG-70 11-30T	Shimano HG-70 11-30T	Shimano HG-70 11-30T	Shimano 8-Speed 11-28T	Shimano 8-Speed 11-28T	Shimano 8-Speed 11-28T
Front Derailleur	Shimano Deore XT	Shimano Deore XT	Shimano Deore XT	Shimano Deore XT	Shimano Deore LX	Shimano STX	Shimano Deore LX
Rear Derailleur	Shimano XTR	Shimano Deore XT	Shimano Deore XTR	Shimano Deore XT	Shimano Deore XT	Shimano Deore XT	Shimano Deore XT
Shifters	SRT-800 X-Ray, Gore	Gripshift SRT-800 X-Ray	SRT-800 X-Ray, Gore	Gripshift SRT-800 X-Ray	Gripshift SRT-600	Gripshift SRT-400	Shimano Rapidfire Deore LX
Bar	Titec 150g Titanium	Titec Hellbent	Axiom 170 Double Butted	Axiom 170 Double Butted	Axiom 170 Double Butted	Aluminum Rise Bar	Axiom 170 Double Butted
Stem	Axiom Pro Threadless	Axiom Pro	Axiom Pro Threadless	Axiom Pro Threadless	Axiom Pro Threadless	Axiom Comp Threadless	Axiom Pro Threadless
Brakes	Magura Tomac Edition	Magura HS-22 Hydraulics	Magura HS-22 Hydraulics	Shimano LX V-Brakes	Shimano LX V-Brakes	Shimano LX V-Brakes	Shimano LX V-Brakes
Brake Levers	Magura Tomac Edition	Magura HS-22	Magura HS-22	Avid 3.0L V-Brakes	Avid 2.0L V-Brakes	Avid 2.0L V-Brakes	Shimano BL-600 V-Brakes
Front & Rear Hubs	Shimano Deore XT	Shimano Deore LX	Shimano Deore XT	Shimano Deore LX	Shimano Deore LX	Shimano STX RC	Shimano Deore LX
Rims	Mavic 221	Mavic 221	Mavic 221	Mavic 221	Mavic 238	Sun CR-18 Double Wall	Sun CR-18 Double Wall
Spokes	Wheelsmith Double Butted	Wheelsmith Double Butted	Wheelsmith Double Butted	Wheelsmith Double Butted	Wheelsmith Stainless	Wheelsmith Stainless	Wheelsmith Stainless
Front & Rear Tires	Panaracer Duster BFC	Panaracer Duster Kevlar	Panaracer Duster Kevlar	Panaracer Duster Kevlar	Panaracer Duster 26x1.95	Panaracer Duster 26x1.95	WTB Velociraptor 26x2.1
Saddle	Norco Custom	S/I Future Manganese	S/I Future Manganese	S/I Future Manganese	Selle Italia Future	Selle Italia Tieffe	Selle Italia Future
Seatpost	Titec Butted	Axiom W/C	Axiom W/C	Axiom W/C	Axiom Pro	Axiom Pro	Axiom Pro
Colours	Brilliant Silver	Bomber Orange	Matte Yellow	Radiant Black	Ball Burnished Silver	Frost Orange	Deep Sea Blue
Sizes	15", 17", 18.5", 20", 22"	S, M, L	15", 17", 18.5", 20", 22"	15", 17", 18.5", 20", 22"	15", 17", 18.5", 20", 22"	S, M, L	15", 17", 18.5", 20", 22"



LOBOS COMP	MOCHA	SASQUATCH	TANGO	MAGNUM	BIGFOOT	BERRETTA	Model
Full Suspension, 3" Travel Interrupted/Active Design, L/A Strut	Easton Reaction O/S, Double Butted Downtube, Replaceable Derailleur Hanger	Tange MTB Double Butted, AFS Tapered Chro-moly Stays	Full Suspension 2.75" Travel, Active/Linkage Design, Aluminum Triangle, Alloy Shock Stays	7005 T6 Aluminum, O/S Double Butted Downtube, Replaceable Derailleur Hanger	Double Butted Chro-moly S-Bend, Tapered Chro-moly Seat Stays, Chro-moly Outer Butted Seat Tube	Chro-moly O/S 34.9mm D-Tube, Outer Butted, Chro-moly S-Tube, S-Bend Stays	Frame
RockShox Indy C 63mm Travel	RockShox Indy C 63mm Travel	RockShox Indy C 63mm Travel	RockShox Quadra 48mm Travel	Marzocchi Zokes 52mm Travel	Chro-moly tapered blades	RST 171B Suspension Fork	Fork
Tange Threadless	Tange Threadless	Tange Threadless	Tange Threadless	Tange Threadless	Oversize MTB 1-1/8"	Threaded 1" Black	Headset
SR-CW26 Interchangeable	Sugino Impel 300	Sugino Impel 300	SR-CW26 Interchangeable	Sugino Impel 250	Sugino Impel 250	Tracer Alloy Crankset	Cranks
Shimano LP-26	Shimano LP-26	Shimano LP-26	Cartridge	Shimano LP-26	Shimano LP-26	Cartridge YST-969	Bottom Bracket
Victor 988 W/Clips	Victor 988 W/Clips	Victor 988 W/Clips	Victor 988 Satin	Victor 988 Satin	Satin cage resin body	Resin ATB	Pedals
Sachs SC-40	Sachs SC-40	Sachs SC-40	UG-50 7-Speed	SS-91 8-Speed	KMC SS-90 8-Speed	KMC UG-50	Chain
Shimano 7-Speed 11-28T	Shimano 8-Speed 11-28T	Shimano 8-Speed 11-28T	Shimano 7-Speed 11-28T	Shimano 8-Speed 11-28T	Shimano STX-RC 8-Speed	Shimano HG-37 7-Speed	Freewheel
Shimano Acera	Shimano STX	Shimano STX	Shimano Acera	Shimano Alivio	Shimano Alivio	SR FD-TP-15	Front Derailleur
Shimano Deore LX	Shimano Deore XT	Shimano Deore XT	Shimano Deore LX	Shimano Deore LX	Shimano LX	Shimano STX	Rear Derailleur
Gripshift SRT 400	Sachs Powergrip "Wavy"	Shimano Rapidfire MC-38	Gripshift MRX 170	Gripshift SRT 400 8-Speed	Gripshift SRT 400 8-Speed	Gripshift MRX-170 21-Speed	Shifters
Aluminum Rise Bar	Axiom 170 Double Butted	Axiom 170 Double Butted	Satin Finish Flat	Aluminum Flat	Alloy Flat MTB	Satin Silver Flat Bar	Bar
Axiom Comp Threadless	Axiom Comp Threadless	Axiom Comp Threadless	Axiom Comp Threadless	Axiom Comp Threadless	Chro-moly Clamp 10° O/S	Satin Silver 25° MTB	Stem
Shimano LX V-Brakes	Shimano LX V-Brakes	Shimano LX V-Brakes	Shimano C-90 Cantis	Shimano C-90 Cantis	Shimano Alivio Cantis	Shimano C-90 Alloy Cantis	Brakes
Tektro 376A V-Brakes	Avid 1.9L V-Brakes	Tektro 376A V-Brakes	Tektro 371A	Shimano Alivio	Shimano STX	Tektro Alloy 3 Finger	Brake Levers
Shimano 7-Speed Csst. F&R Q/R	Shimano STX-RC	Shimano STX-RC	O/S Alloy Q/R Front & Rear	O/S Alloy Q/R Front & Rear	O/S Cassette L/A Q/R	Alloy Q/R Formula	Front & Rear Hubs
Araya GR710 32H	Sun DW-6000 Double Wall	Araya TM-820 Double Wall	Araya GP710 32H	Sun Double Wall 32H	Sun Double Wall 32H	Alex VP-18F Alloy	Rims
2.0 Stainless	Wheelsmith Stainless	2.0 Stainless	2.0 UCP	2.0 UCP	Stainless 14G	UCP 14G	Spokes
Panaracer Duster 26x1.95	WTB Velociraptor 26x2.1	Panaracer Duster 26x1.95	Kenda Bear Claw/Trac	Panaracer Smoke/Dart	Panaracer Smoke/Dart	Bearclaw/Beartrac 26x2.0	Front & Rear Tires
Selle Italia Tieffe	Selle Italia Tieffe	Selle Italia Tieffe	Velo 285	Velo 285	Selle Italia Tieffe Racing	Velo MTB Supersoft	Saddle
Axiom Comp	Axiom Comp	Axiom Comp	Aluminum Micro Adjust	Aluminum Micro Adjust	Alloy Micro Adjust	Alloy Micro Adjust	Seatpost
Radiant Moss	Ball Burnished Silver	Burnt Copper	Matte Yellow	Satin Silver	Matte Red	Radiant Black	Colours
S, M, L	15", 17", 18.5", 20", 22"	15", 17", 18.5", 20", 22"	S, M, L	15", 16", 18", 20", 22"	15", 16", 18", 20", 22"	15", 16", 18", 20", 22"	Sizes



Model	KOKANEE	BUSH PILOT	KATMANDU	MOUNTAINEER SL	CHEROKEE	AXIA	AVANTI
Frame	Chro-moly Down Tube, Top Tube, Outer Butted Chro-moly Seat Tube Chro-moly S-Bend Stays	Chro-moly O/S 34.9mm D-Tube, Outer Butted Chro-moly S-Tube, S-Bend Stays	Chro-moly 34.9mm D-Tube, Outer Butted Chro-moly S-Tube, S-bend Stays, Semi Forged Vert. Drop-outs	O/S 39mm D-Tube, 34.9mm T-Tube, S-Bend Stays	O/S 39mm D-Tube, 34.9mm T-Tube, S-Bend Stays	Chro-moly Double Butted Hybrid Design	Hybrid Design, Chro-moly Main Tubes
Fork	Chro-moly Tapered Blades	Chro-moly Tapered Blades	Long Radius Tapered Blades	Long Radius Tapered Blades	Long Radius Tapered Blades	Chro-moly W/Rack Mounts	Chro-moly Long Radius
Headset	Threaded 1" Black	Threaded 1" Black	Threaded 1" Black	Threaded 1" Black	Threaded 1" Black	1" Sealed Mech	1" Sealed Mech
Cranks	Tracer Compact Drive	Alloy Triple Sugino or Tracer	Alloy Triple Sugino or Tracer	Alloy Triple Sugino or Tracer	ATB 170mm, 48/38/28T	Sugino Fuse 500 46T	Shimano FC-500 48T
Bottom Bracket	Cartridge YST-969	Cartridge YST-969	3 pc. BB Set	3 pc. BB Set	3 pc. BB Set	Shimano LP-26	Shimano LP-26
Pedals	Resin ATB	Resin ATB	Resin ATB	Resin ATB	Resin ATB	Victor 988 W/Clips	Victor 988
Chain	KMC UG-50	KMC UG-50	KMC UG-50 HG	KMC UG-50 HG	KMC HP-20 SIS	Sachs SC-40	Sachs SC-40
Freewheel	Shimano HG-50 7-Speed	Shimano 7-Speed	Shimano 7-Speed	Shimano 7-Speed	Shimano 5-Speed	Shimano 8-Speed 11-28T	Shimano 8-Speed 11-28T
Front Derailleur	Shimano Acera-X	SR FD-TP-15	Shimano TY-30	Shimano TY-30	Shimano TY-15	Shimano FD-C500	Shimano FD-C500
Rear Derailleur	Shimano STX	Shimano Alivio	Shimano Acera-X	Shimano TY-30 7-Speed	Shimano TY-15	Shimano Deore XT	Shimano Deore XT
Shifters	Shimano STX Rapidfire 21-Speed	Gripshift MRX-170 21-Speed	Gripshift MRX-170 21-Speed	Gripshift MRX-170 21-Speed	Gripshift MRX-170 15-Speed	Shimano Rapidfire Deore LX	Gripshift SRT-600
Bar	Satin Silver Flat Bar	Satin Silver Flat Bar	Satin Silver Flat Bar	Satin Silver Flat Bar	Satin Silver Flat Bar	Axiom 170 Double Butted	Axiom 170 Double Butted
Stem	Satin Silver 25° Rise MTB	Satin Silver 25° Rise MTB	Satin Silver 40° Rise MTB	Satin Silver 40° Rise MTB	Satin Silver 40° Rise MTB	JD Flex Stem	JD Flex Stem
Brakes	Shimano C-90 Alloy Cantis	Shimano C-90 Alloy Cantis	C-S 852A Alloy Cantis	C-S Light Alloy Cantis	C-S 876 S Cantis	Shimano LX V-Brakes	Shimano Alivio Cantis
Brake Levers	Shimano STX	Tektro Alloy 3-Finger	Tektro Alloy 3-Finger	C-S Alloy 3-Finger	C-S Alloy 3-Finger	Shimano M-600 V-Brakes	Shimano Alivio
Front & Rear Hubs	O/S Alloy Q/R Formula Csst.	Alloy Q/R Formula	Formula Q/R Alloy O/S	Formula Front Q/R, Black	Formula 36H ATB, Black	Rear: STX RC, Front: Formula	Rear: STX RC, Front: Formula
Rims	Alex VP-18F Alloy	Alex VP-18F Alloy	Alloy 26x1.5 36H	Alloy 26x1.5 36H	Alloy 26x1.5 36H	Vuelta Buffalo 700C	Vuelta Buffalo 700C
Spokes	UCP, 14G	UCP, 14G	UCP, 14G	UCP, 14G	UCP, 14G	2.0 UCP	2.0 UCP
Front & Rear Tires	Skinwall Bearclaw/Beartrac	Bearclaw/Beartrac 26x2.0	On/Off Road 26x1.90	Thunder off-road 26x1.90	Thunder off-road 26x1.90	Kenda Skin 38C	Kenda Skin 38C
Saddle	Velo MTB Supersoft	Velo MTB Supersoft	Velo MTB Supersoft Foam	ATB Soft Foam	ATB Soft Foam	Velo Plush W/Springs	Velo Plush W/Springs
Seatpost	Alloy Micro Adjust	Alloy Micro Adjust	Satin Silver 300mm 25.4mm	300mm 25.4mm	300mm 25.4mm	JD Suspension Post	Axiom Comp
Colours	Vibrant Black or Matte Copper	Burnt Burgundy (M&L) Bright Silver/Grey (M) Matte Red (M)	Satin Silver or Jewel Green	Burgundy/Satin Silver (M&L), Silver/Glacier (M) Yell/Matte Yell (M), Matte Red (M)	Red/Matte Titanium Ink Blue/Silver	Ink Blue	Anthracite
Sizes	16" 18", 20", 22"	Mens: 15", 16", 18", 20", 22" Ladies: 17", 19"	15", 16", 18", 20", 22"	Mens: 15", 16", 18", 20", 22" Ladies: 17", 19"	15", 16", 18", 20", 22"	16", 18", 20", 22"	16", 18", 20", 22"





**Your 1997 Norco Dealer**

Your feedback is extremely important to us. If you have any questions or comments about our bicycles or any of the other products we carry, please feel free to write us. We want to hear from you!