

MIDDLEBURN

PRODUCT CATALOGUE



DESIGNED & MANUFACTURED BY
MIDDLEBURN ENGINEERING LTD. HAMPSHIRE. ENGLAND
INTERNATIONAL SALES: FAX +44 1420 23796

MIDDLEBURN

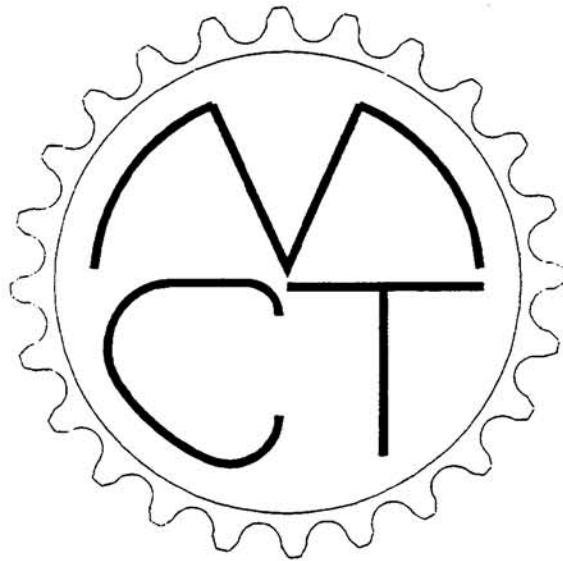

Machined

Masterpieces

Table of Contents

CRANKS:

- RS2 MTB Cranksets
- RS3 MTB Cranksets
- RS4 ROAD Cranksets
- RS2 Tandem Cranksets

HUBS:

- Front Suspension Hub (MTB, Road)
- Rear Suspension Hub (MTB, Road)

CHAINRINGS:

- Standard Rings (ATB, CD)
- HARDCOTE Rings (NEW!)
- Downhill Rings (NEW!)
- SlickShift Rings (NEW!)
- STX Adapters (NEW!)

VARIOUS:

- One-Key Release Bolts
- Cable Oilers
- Bullet Valve Caps

Middleburn RS2 Cranks

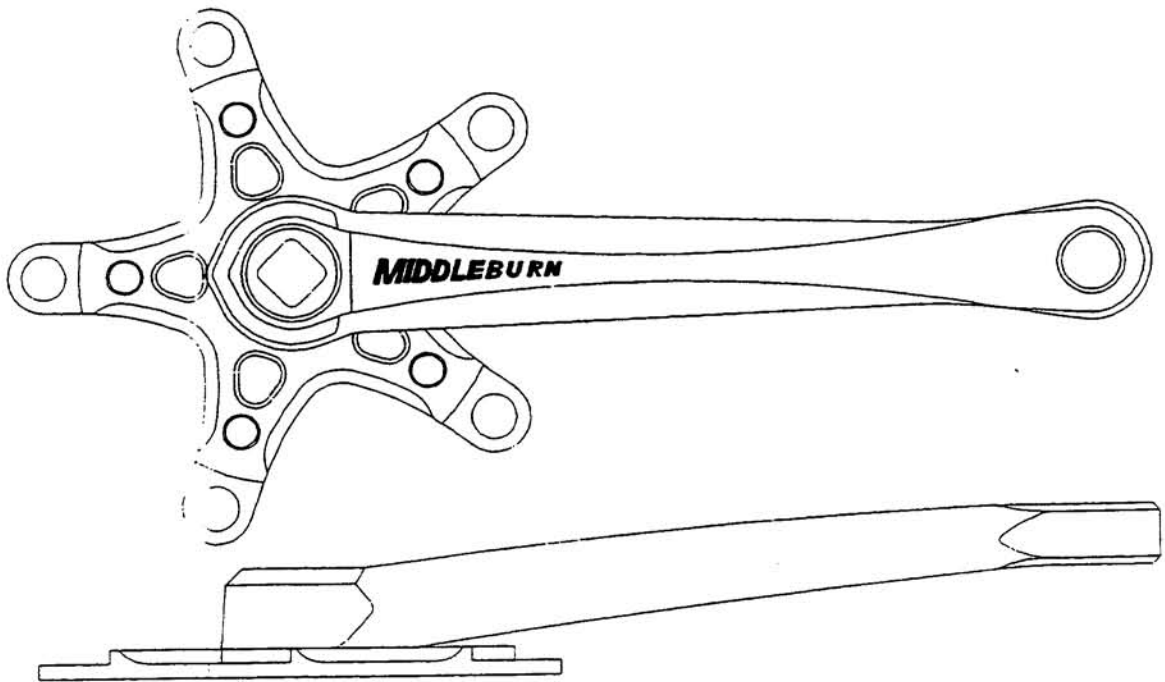

Product :	MIDDLEBURN RS2 Cranks	
Weight :	Standard MTB (175mm)	395g
	Micro/Compact drive (175mm)	385g
Sizes :	170mm & 175mm	
Features :	<ul style="list-style-type: none">• Lightweight• Reduced 'Q' Factor.• Square Drive Crank/ Spider interfaces.• Interchangeable spider for MTB, Road and Micro/Compact Drive	
	Materials :	Crank & Spider: 7075 T6 Aluminium Alloy Retainer Bolts: High Tensile Steel Nickel Plated Spacers: HE30 Aluminium Alloy

Colours :

Anodised silver crank arms with the following colour Spiders: Blue, Red, Purple, Black, Silver, Gold & Green

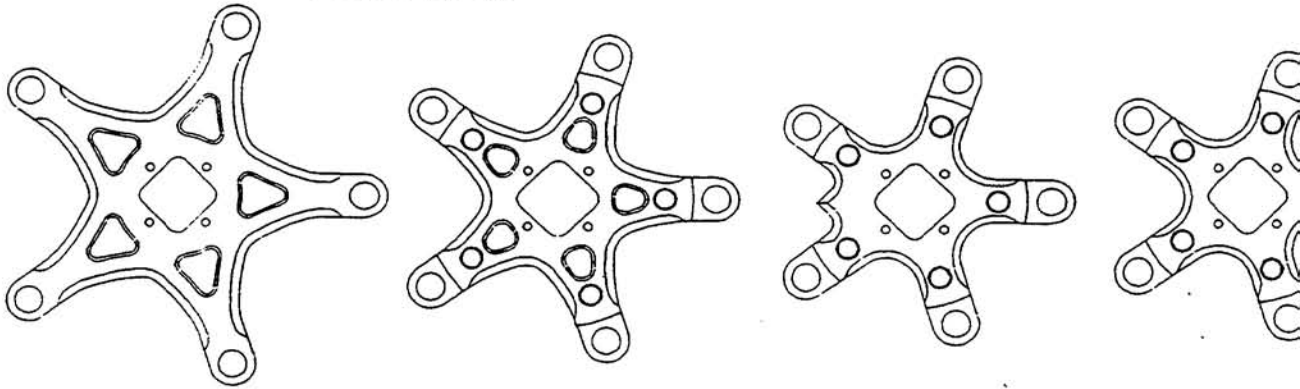

Product :

MIDDLEBURN Spiders

Weight:

Standard MTB

56g - PCD74mm,110mm

Micro/Compact

45g - PCD56mm/58mm,94mm

Road

72g - PCD130mm

Colours:

Blue, Red, Purple, Silver, Gold, Green and Black

Compatibility :

Either 5/4 arm spider patterns (eg. Ritchey Logic & Sugino)

Middleburn RS3 CRANKS

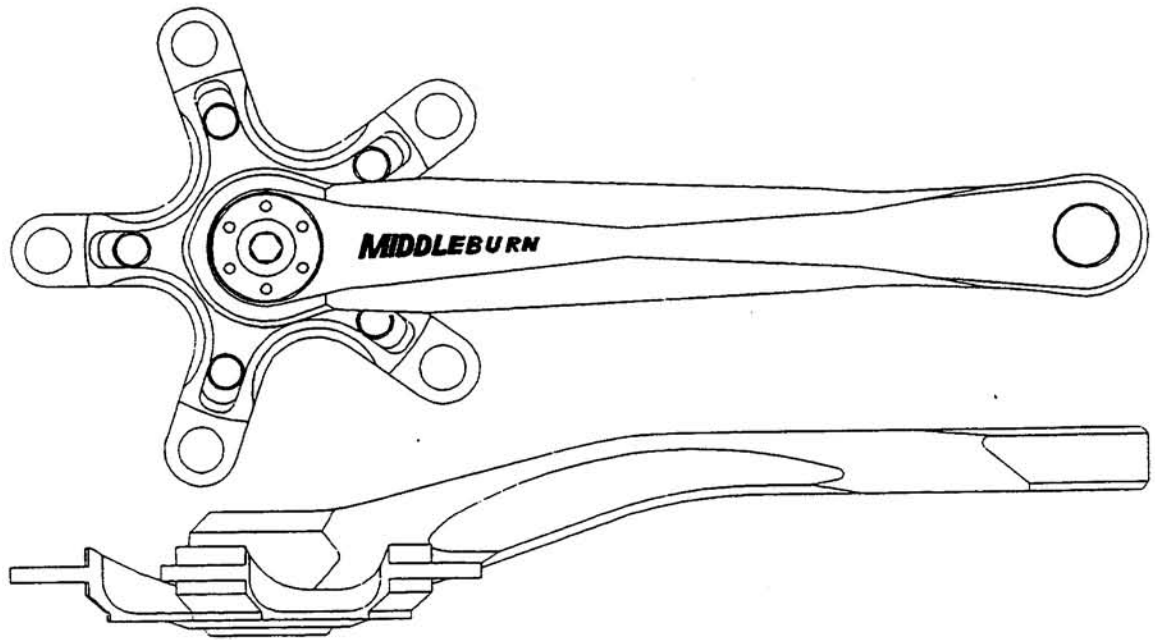

Product : MIDDLEBURN RS3 Cranks

Weight :	Standard MTB	175mm	416g
	Micro/Compact drive	175mm	405g

Sizes : 170mm ,175mm & 180mm

Features :

- Lightweight and very stylish
- Low profile ,160mm 'Q' factor
- Increased rigidity with 107mm axle compatibility
- Square Drive Crank/Spider interfaces
- Interchangeable spider for MTB, Road and Compact Drive

Materials : Crank & Spider: Aerospace 7075 T6 Aluminium Alloy
Spider: Aerospace 2014A T6 Aluminium Alloy

Colours: Anodised silver crank arms.

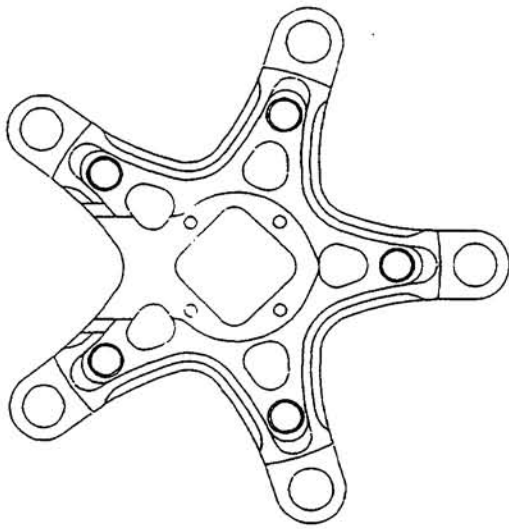

MTB

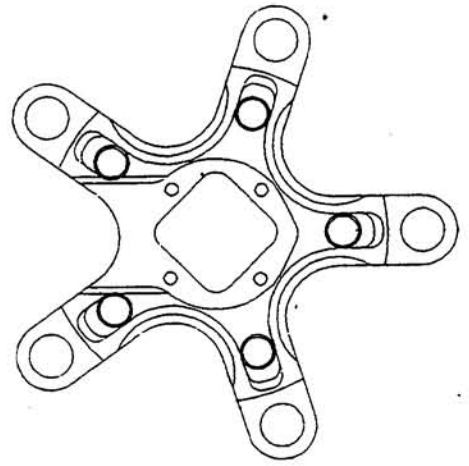

Compact

Product : MIDDLEBURN RS3 MTB Spiders

Weight: Standard MTB 56g PCD 74mm, 110mm
Compact 47g PCD 58mm, 94mm

Features: 3D dished webbed spider gives incredible stiffness/weight ratio

Colours: Blue, Red, Purple, Green, Silver, Gold, and Black

Middleburn RS4 CRANKS

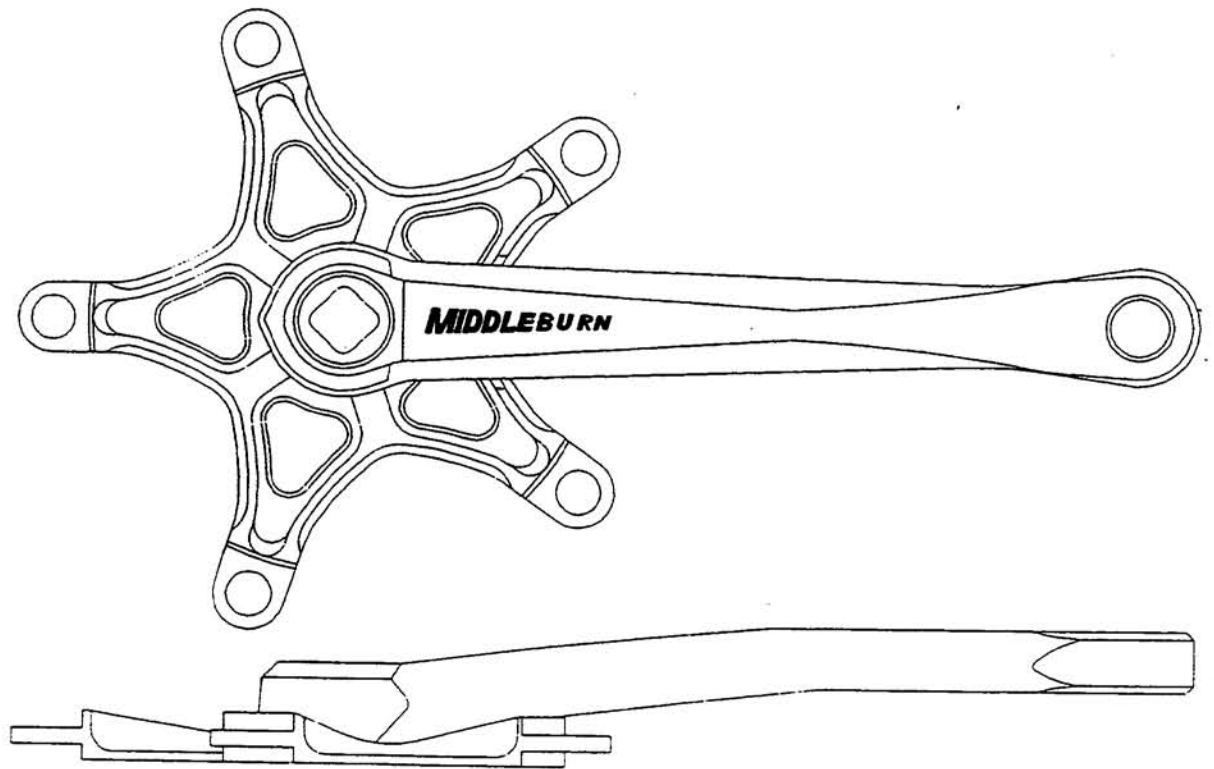

Product : MIDDLEBURN RS4 Cranks

Weight : 172.5mm 412g

Sizes : 170mm ,172.5mm, 175mm, 180mm

Features :

- Uses 103mm B/Bracket Axle
- Low 'Q' Factor (145mm)
- Square Drive spider location
- Lighter More Efficient Design
- Spider available in 7 wild anodised colours, with silver anodised crank arms
- Webbed spider for increased stiffness
- Compatible with all major drivetrain systems
- Machine cut threads & square taper
- Incidental lengths from 170 to 180mm

Middleburn RS2 Tandem Cranks

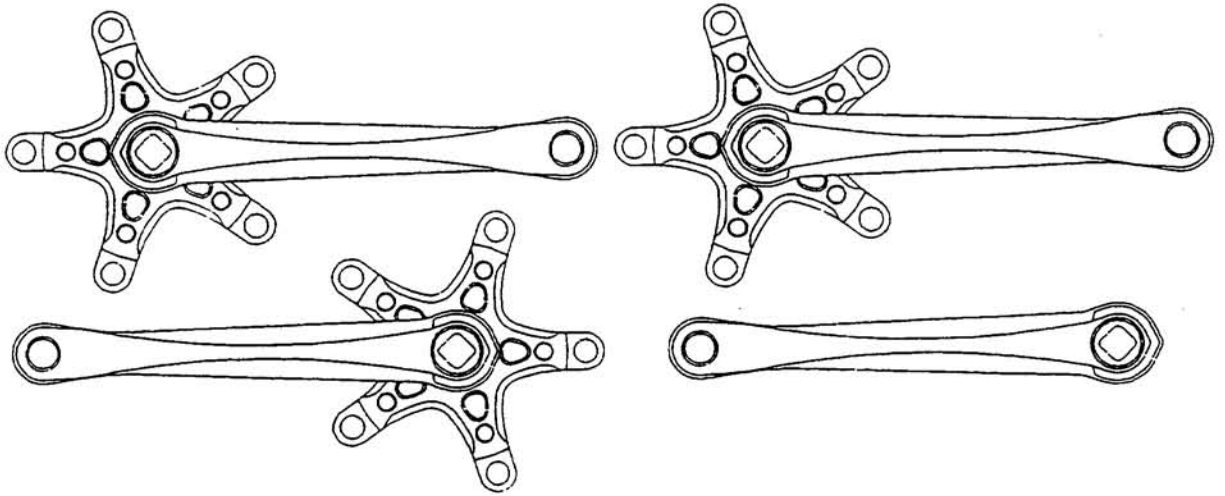

Product : MIDDLEBURN RS2 Tandem Cranks

Sizes : 170mm , 175mm. (Mixed sets available)

Weight : Approx. 1100gms a set.

Features :

- Chainrings from 20T to 56T available
- Spider, Chainrings, & Outer bolts available in 7 colours
- 3 formats of spider for MTB, Compact (Triple) or Road (Double)
- NEW Lower profile reduced 'Q' factor

Materials: Crank arms : CNC machined from aerospace 7075-T6 Aluminium Alloy

Spider : CNC machined from aerospace HE15-T6 Aluminium Alloy

Retainer bolts : High tensile nickel plated

Spacers : HE30 Aluminium Alloy

Accessories : Self Extractor Bolts:

TiN coated Titanium/Aluminium 22g

Stainless /Aluminium 36g

Cross-Over Rings :	COMPACT	30-46T
	MTB	34-52T
	ROAD	39-56T

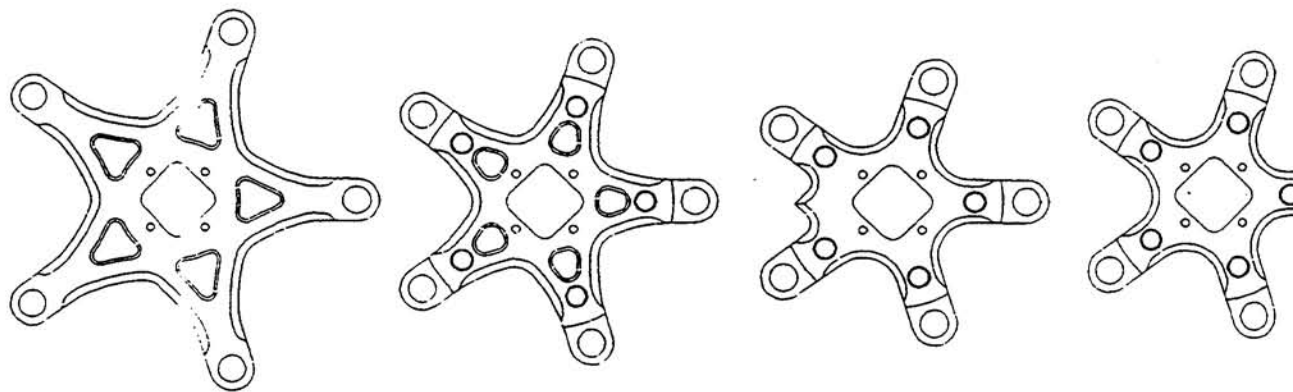

Product : MIDDLEBURN Spiders

Weight:	Standard MTB	56g	PCD 74mm, 110mm
	Micro/Compact	45g	PCD 56mm/58mm, 94mm
	Road	72g	PCD 130mm

Colours: Blue, Red, Purple, Silver, Gold, Green and Black

Compatibility : Either 5/4 arm spider patterns (eg. Ritchey Logic & Sugino)

Middleburn Rear Suspension Hub

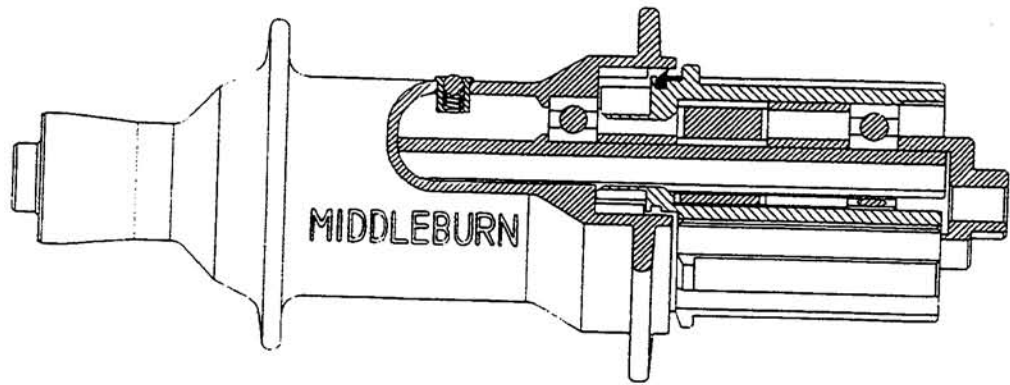

Product : MIDDLEBURN Rear Suspension Hub

Weight : 265g

Sizes : 28•32•36 Hole Versions Available

Features :

- Lightweight
- 1 Needle roller unit, 3 sealed cartridge bearings
- 15mm tubular spindle for increased stiffness
- 4 ratchet pawls with individual springs
- Asymmetric flange geometry for optimum spoke configuration
- Oil port & syringe supplied for easy maintenance
- Compatible with Shimano hyperglide cassettes
- Effective labyrinth seal & selective lip sealing minimises friction and dirt ingress

Materials : CNC machined from 2014 T6 Aluminium Alloy
Cassette body - 6Al - 4V Titanium Alloy

Colours : Blue, Red, Purple, Green, Silver, Gold, and Black

SLICK-SHIFT

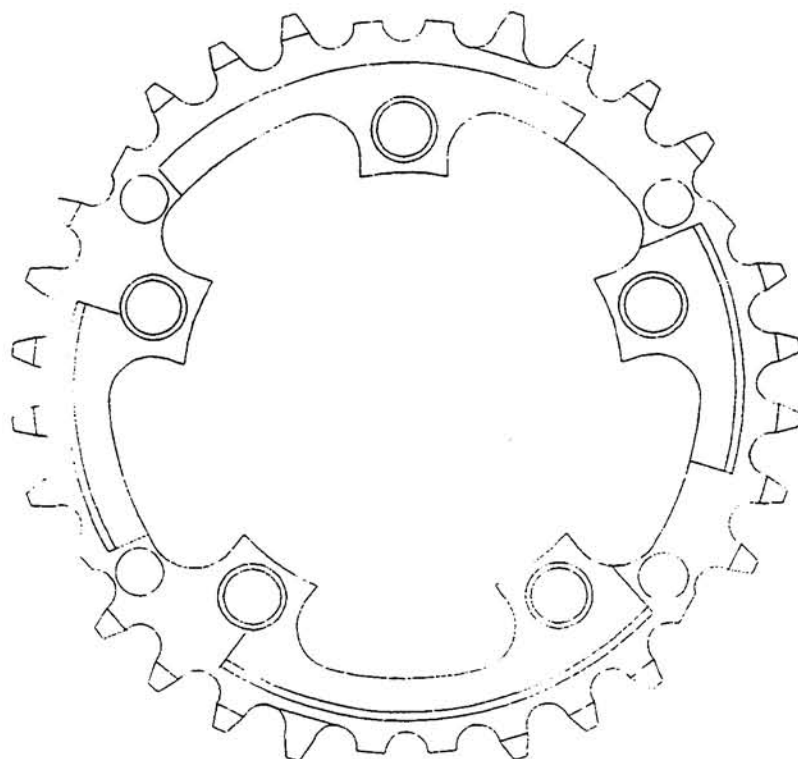

Product : MIDDLEBURN Slick-Shift Chainrings

Sizes : 22•32•42 Teeth (Compact Drive Only)

Features :

- 'Gappy-tooth' technology
- Continuous power transfer whilst shifting
- Machined ramps for effortless shiftings
- Pick-up pins lift the chain under full Load
- Stainless steel pins won't rust
- Quieter shifting, Stealth the opposition!

Material : CNC machined from 2014A-T6 Aluminium Alloy

Colours : Blue, Red, Purple, Green, Silver, Gold, and Black

COMPATABILITY OF MIDDLEBURN CHAINRINGS WITH STX & ALIVIO								
Year	Crank	Part No.	Outer BCD	Inner BCD	No. of Teeth	MBum Outer	MBum Adapter	MBum Inner*
1994	ALMO	FC-MC11	95	58	34T	NO	CR5I34	YES
1994	STX	FC-MC30	95	58	34T	NO	CR5I34	YES
1994	STX	FC-MC31d	95	58	34T	NO	CR5I34	YES
1995	STX	FC-MC32	94	58	32T	YES	CR5I32	YES
1995	STX-RC	FC-MC33	94	58	32T	YES	CR5I32	YES
1996	STX	FC-MC34	94	58	32T	YES	CR5I32	YES
1996	STX-RC	FC-MC36	94	58	32T	YES	CR5I32	YES

Middleburn STX Adapters

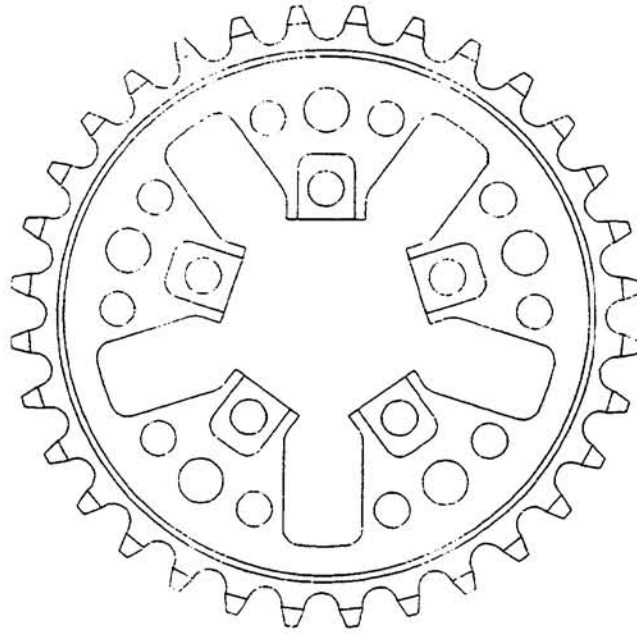

Product : MIDDLEBURN STX Adaptors

Weight : 80g

Sizes : 32 & 34 Teeth

Features:

- Lightweight
- Quick and easy replacement
- Long lasting

Materials : CNC machined from 2014-T6 Aluminium Alloy

Finish : Silver anodised.

Compatibility : Please consult chart to confirm

Middleburn Self Extractor Bolts

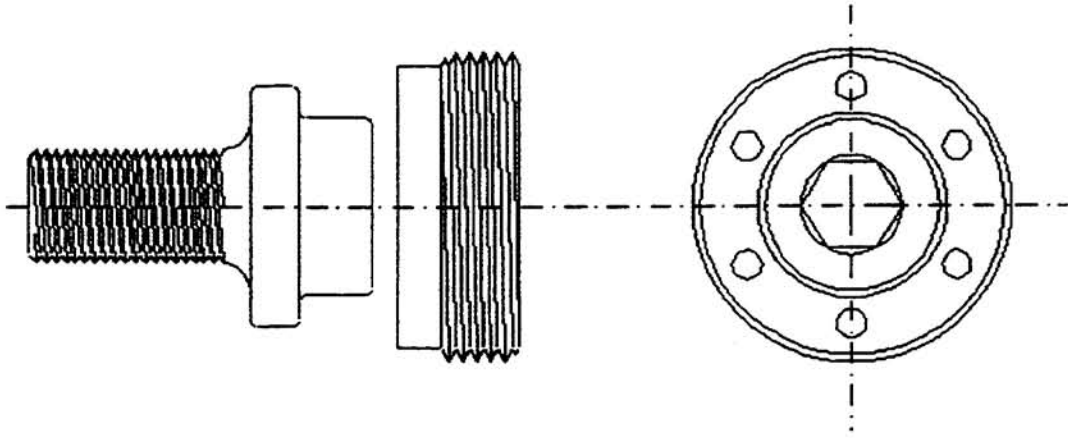

Product : MIDDLEBURN Self-Extract Bolts

Weight : Stainless 36g
 Titanium 22g

Features :

- Lightweight
- 6mm Allen key
- Aluminium Bronze anti friction washers
- Titanium Nitride (TiN) coating prevents seizing
- Quick easy maintenance : no heavy tools required to remove your crank

Materials :

- 6Al - 4V Titanium Alloy with TiN coating
- 316 Stainless Steel
- Caps- 2014A T6 Aluminium Alloy

Colours : End caps - Blue, Red, Purple, Green, Silver, Gold, and Black

Middleburn Chainrings

MIDDLEBURN Advanced chainrings combine two major design features; firstly computer generated tooth profiles and secondly CNC machined surfaces. The former allows the tooth form to be controlled precisely, resulting in a unique tooth profile for any given ring size. Most other manufacturers simply join adjacent teeth together as the tooth profile becomes further apart resulting in a flat surface alien to roller chain geometry, hence Middleburn chainrings ensure the best possible load surface is obtained. Pressed rings automatically have less load surface available due to the method of their production. CNC machining results in true cut surfaces optimising the chain to ring contact area resulting in improved power transfer and increased durability. Hand finishing further removes any rough surfaces left by the manufacturing process which would otherwise increase friction.

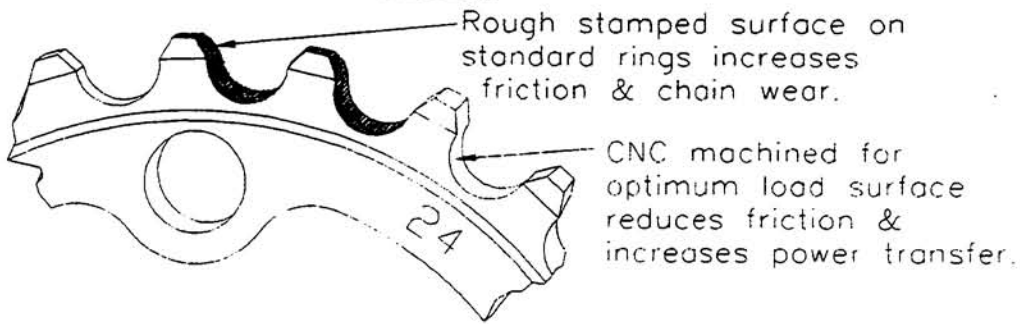

Standard ring

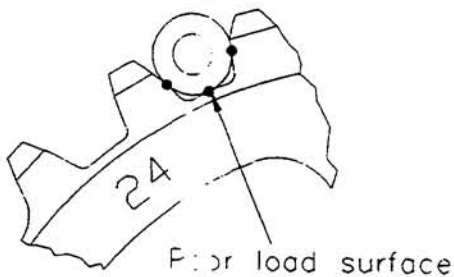

Middleburn ring

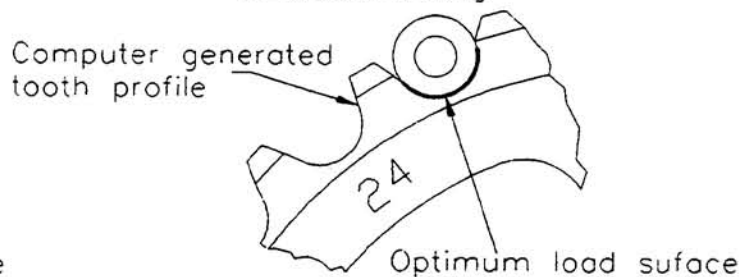

Standard exit path

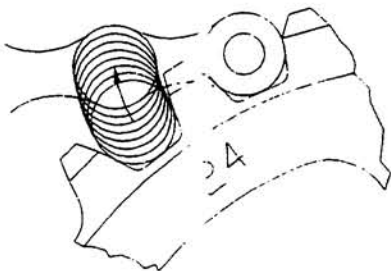

Low friction exit path

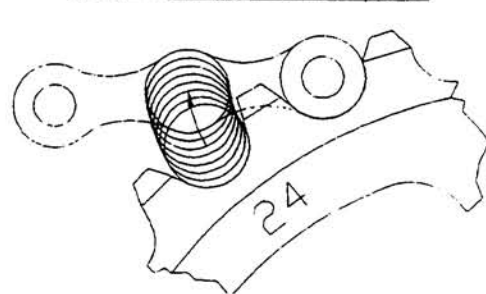

<u>Product:</u>	<u>Sizes:</u>	<u>Weight:</u>
Inner MTB	24-28 *	24T - 20g
Middle MTB	34-40 *	36T - 40g
Outer MTB	46-52 *	46T - 66g
Micro/Comp.	20,22,24,26 30,32,34,36 40,42,44,46	
Road	39,42,44 52,53,54,56	20T - 17g 39T - 39g

* Indicates 1 tooth increments

Materials : Aerospace 2014T6 Aluminium Alloy

Chainring bolts : Aluminium (9g) ,Stainless Steel (16g)

Colours : Blue, Red, Purple, Green, Black, Gold and Silver

Middleburn Hardcote chainrings - longer lasting!

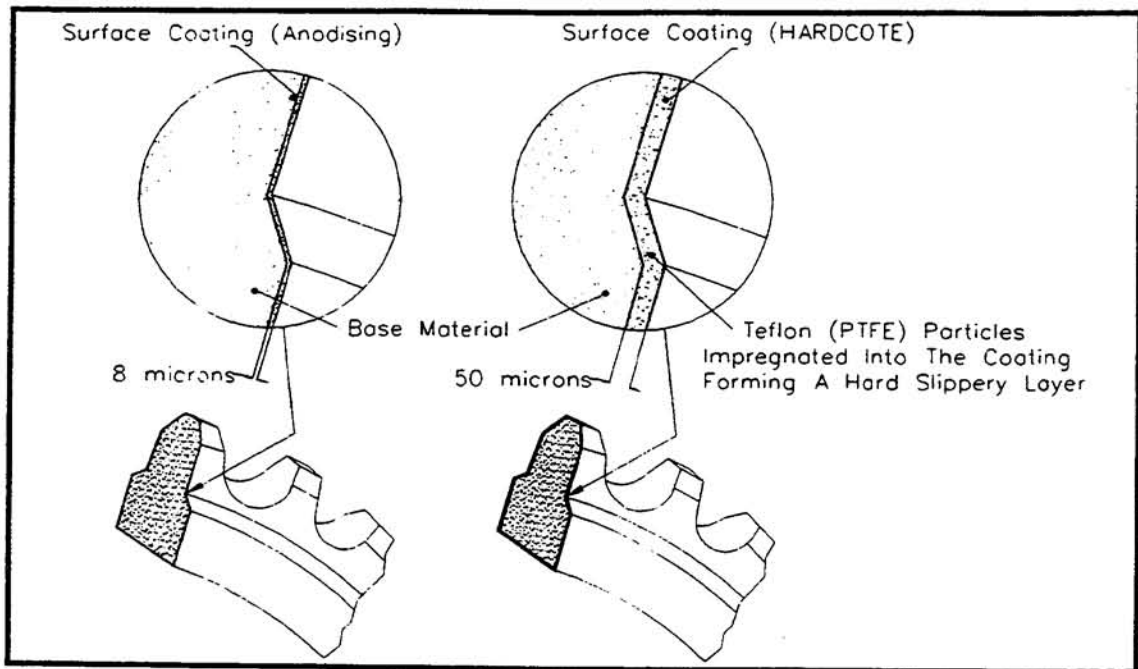

This revolutionary new PTFE impregnated hard coating adds much increased life and reduced friction to our already durable chainrings as an option to colour anodising.

- This 50 μ deep coating has a coefficient of friction of 10 times better of that of normal hard anodising.
- The wear resistance is 4 times that of hard anodising (as found on rims).

The comparisons above are based on hard anodising which is much harder than that found on chainrings and other components. This can be seen by the wear rate on normal silver rims as opposed to grey "CD" rims.

The performance of this coating is such that it is used in suspension and steering components by a majority of the current top F1 motor racing teams.

Middleburn Downhill Chainrings

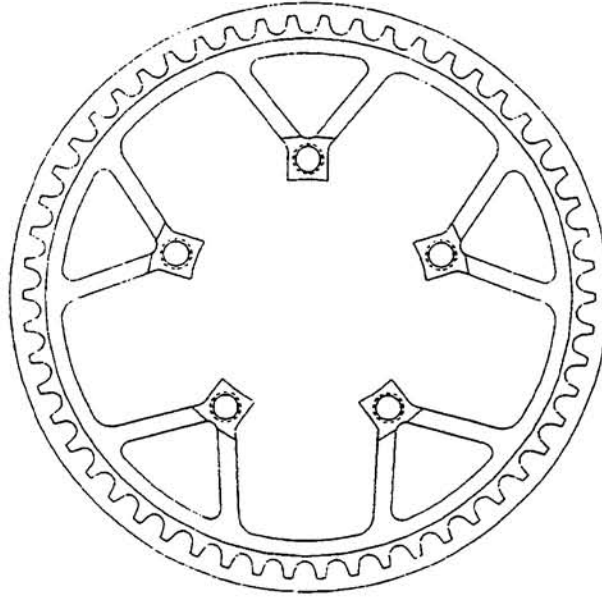

Product : MIDDLEBURN Downhill Chainrings

Sizes : 48 - 62 Teeth Compact./Standard

Features :

- CNC Machined from 10mm plate for incredible strength and rigidity
- Integral chain guard to eliminate chain throw
- Computer generated tooth profiles for accurate chain engagement
- Unique tooth profile for any given ring size increases durability
- Smooth full load surface

Material : 2014-T6 Aluminium Alloy

Colours : Blue, Red, Purple, Green, Silver, Gold, and Black

Middleburn Bullet Valve Caps

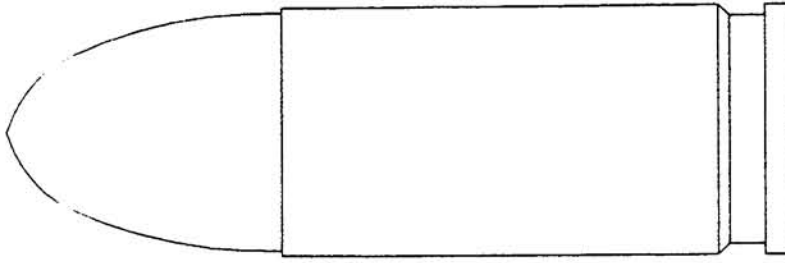

Product : MIDDLEBURN Bullet Valve Caps

Sizes : Schraeder & Presta

Features :

- 9mm Replica (Schraeder) - Arnie'd love 'em!
- Presta .22 Calibre
- Machined from billet aluminium
- Available in 7 flavours
- Functional, fun, & funky!
- Terminate the opposition!

Material : 2014-T6 Aluminium Alloy

Colours : Blue, Red, Purple, Green, Silver, Gold, and Black

Middleburn Cable oilers

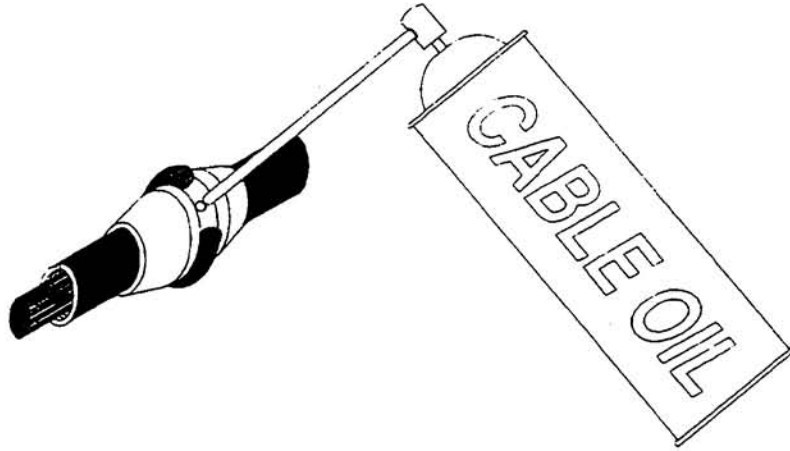

- Product :** MIDDLEBURN Cable Oilers
- Weight :** 0.9g
- Sizes :** 3.6mm (new Shimano), 5mm & 6mm diameters
- Features :**
- Lightweight
 - Oil port to take GT85 and WD40 spray nozzles.
 - Quick and easy maintenance
- Materials :** 2014 T6 Aluminium Alloy with Nitrile rubber 'O' ring
- Colours :** Blue, Red, Purple, Green, Silver, Gold, & Black.

DISTRIBUTORS

DENMARK

Master Consult ApS
Skaffervej 8 st.
DK-2400
Kobenhavn NV

Tel: +45 35 82 30 32

Fax: +45 35 82 30 34

FINLAND

MT-Bike
Koulukatu 40
80100 Joensuu

Tel: +358 73 224891

Fax: +358 73 224892

FRANCE

Sunex
Quartier La Palud
Lot No. 4
83600 Frejus

Tel: +33 94 53 00 03

Fax: +33 94 52 18 38

GERMANY

Bike Trading
Neudorfer Strasse 195
47057 Duisburg

Tel: +49 203 370152

Fax: +49 203 370124

ISRAEL

Isgad Agencies & Trade Ltd.,
Kibbutz Gaash
60951
Israel

Tel: +972 9 563170

Fax: +972 9 560165

ITALY

Motor Quality
Via Venezia ang, via Carducci
20099 Sesto San Giovanni
Milano

Tel: +39 222 409631

Fax: +39 222 476420

JAPAN

A & F
1-1-9 Okubo
Shinjuku-ku
Tokyo 169

Tel: +91 3 3209 7575

Fax: +81 3 3209 7497

SCANDINAVIA

Scandinavian Sports Connection
Holmgaten 26
791 71 Falun

Tel: +46 23 138 90

Fax: +46 23 290 04

SPAIN

Esports Jorma
Av. Francesc Cairat s/n
Sant Julia De Loria
Andorra

Tel: +376 844133

Fax: +376 843022

UK

Zoobits
Units 18-19, Enterprise Estate
Station Road West
Ash Vale
Hants GU12 5QJ

Tel: 01252 378110

Fax: 01252 378120