

19  
93

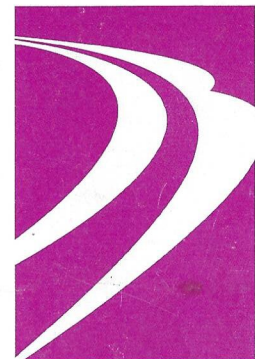

**DIAMOND  
BACK**

◆ Cross & Road ◆

# ◆ Cross Bikes ◆

Avenir's brand new patent pending Comfort Plus™ saddle was designed to bring old-fashioned comfort to today's high-performance cross bikes. Our cross bikes put you in a comfortable riding position to begin with. Why not enjoy the comfort of the plushiest saddle on the market as well?

The Comfort Plus™ updates the old concept of saddle springs by bringing back coil springs and longitudinal springs to absorb road shock. In this new version of an old idea, the top of the saddle is also padded with form-fitting gel, which provides supreme comfort. And this saddle is lighter than you might expect with its poly-carbonate support structure. Riding a bike should never hurt. With a Comfort Plus™ saddle, riding a bike is a tactile delight.

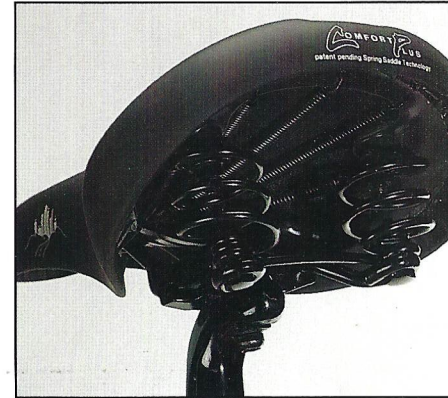

## ◆ Comfort Plus ◆

Diamond Back cross bikes are extremely versatile and ingeniously designed. You'll want to take them everywhere you go and they'll do almost anything you ask of them. A cross bike puts you in the same upright, comfortable position as a mountain bike, and will certainly allow you to venture into the dirt. But a cross bike is quicker and lighter, and therefore a perfect choice for fun and fitness riding on any surface.

You'll especially like Diamond Back's patent pending Comfort Plus™ saddle. These are a unique update on the comfy "mattress" saddle from years ago. They have the same multi-spring comfort, but we've added form-fitting gel, and improved the overall design.

We like to encourage bicycle commuting as much as possible, and we think our cross bikes are perfect for riding to work or running errands. We've equipped each with eyelets and mounts for racks and fenders. And if you foresee loading up for the long haul, cross bikes are perfect for touring. They'll easily accommodate racks and panniers and give you a wide gearing range with easy to operate gear controls. All our cross bikes come with fast, lightweight 700C wheels and smooth rolling cross-terrain tires. This, combined with their durable frames and high-performance components, assures a comfortable, stable ride in any condition. A Diamond Back cross bike will take you anywhere you want to go — around the block or around the world.

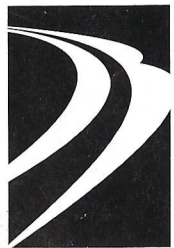

**DIAMOND  
BACK**

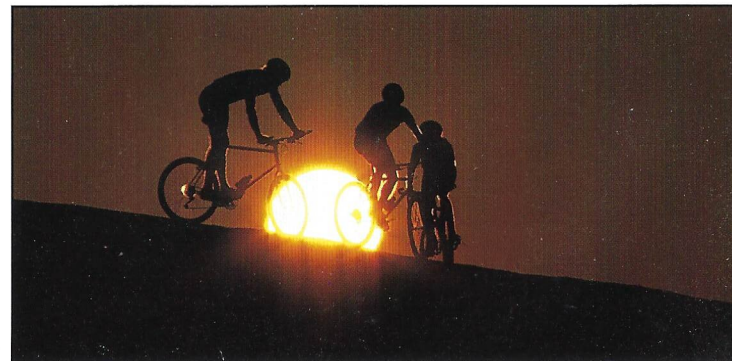

Diamond Back has long enjoyed an impeccable reputation for building bikes of the very highest quality. We've earned that reputation for two very simple reasons.

First, we practice a simple philosophy that goes into every bike we build: Make them strong, make them fast, and make them built to last.

Second, Diamond Back is a company of riders.

Because we love to ride, we understand what you're looking for in a bicycle; the very same things we look for-- bikes that are exciting to ride, bikes that perform, bikes that give you the very best value, comfort and control at any price level.

Every Diamond Back bicycle is designed individually, from the ground up, to suit the lifestyles, tastes and abilities of a whole spectrum of bicycle riders. That's why our 1993 line is our most diverse line of bicycles ever.

We also think a bike should be just a bit "titillating," both in looks and in performance. The garages of the world are full of dull bikes that never get ridden. Diamond Backs are bikes you can't wait to ride, the kind you find yourself daydreaming about during a day's toil.

Our exciting, lightweight road bike line takes our racing tradition forward from triathlon stars Dave Scott and Mike Pigg, to National Road Champion Rory O'Reilly, and beyond. No matter what Diamond Back bicycle you buy, you'll see and feel the same quality and performance that has distinguished every Diamond Back for 26 years.

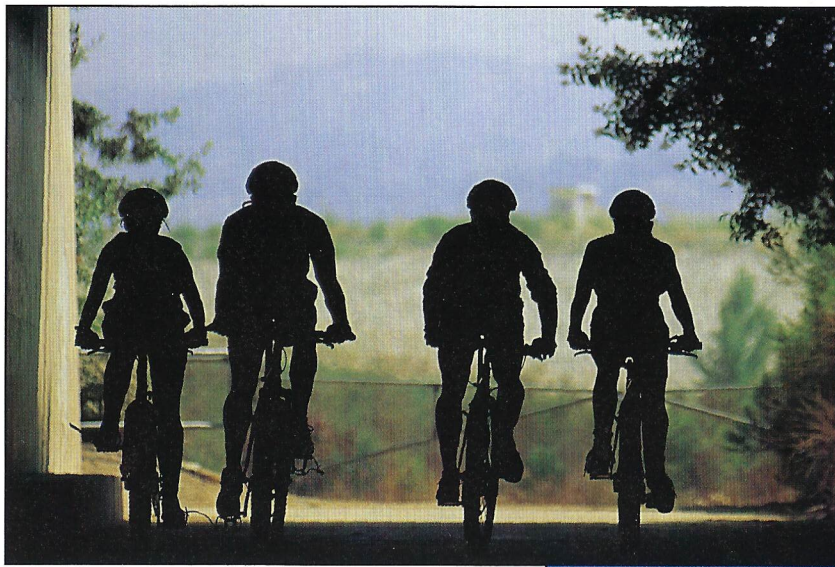

# ◆ Road Bikes ◆

CROSS

# OVER RIDE

## OVER RIDE

**FRAME:** TrueTemper AVR main frame and 100% CR-MO fork.

**GROUP:** SHIMANO Altus A-10, A-20 group.

**WHEEL SET:** Shimano sealed alloy hubs, stainless steel spokes, and skinwall tires.

**FEATURES:** Shimano Altus sealed cassette bottom bracket, ZOOM cross stem and bar, and Avenir Comfort Plus Saddle.

The Over Ride is the essence of cross-bike versatility. With its True Temper AVR frame and chromoly unicrown fork it's definitely a performer, a bike you can push hard on a fast workout. It comes with 41C Hill Street Cruise skinwall tires that handle fast street-riding, urban obstacles, and dirt roads with equal ease. You can venture far and wide with the 21-speed gear range, but no matter how fast or far you ride, the Avenir Comfort Plus saddle keeps you smiling.

Elegant, fast and functional: the Over Ride is an overriding reason to ride.

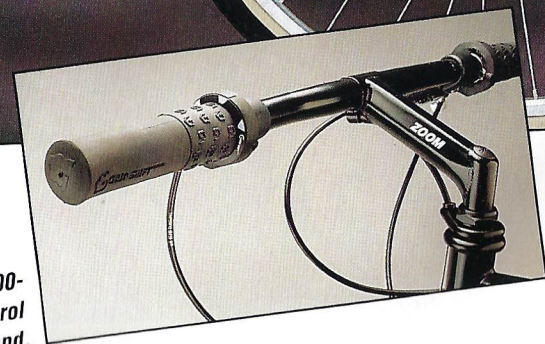

New GripShift SRT-300-  
Positive gearing control  
on hand

# CROSS CAMPUS



## ◆ CROSS CAMPUS ◆

**FRAME:** Hand crafted CR-MO main frame.

**GROUP:** Shimano **ALTUS** 21-speed group with **DUAL SIS** and Multi-condition braking.

**WHEEL SET:** Shimano alloy quick release front and rear hubs, U.S. made alloy rims.

**FEATURES:** **AVENIR** Comfort Plus Saddle and quick-adjust seat clamp.

**S**tyle, sturdy, and a great value — that's the Cross Campus. It's a bike that invites you to ride hard for a workout or easy for fun, but always in comfort. The frame is sturdy but light chromoly, TIG-welded by hand. The wheels are lightweight alloy, with quick release hubs for transporting ease, and the drivetrain features Shimano's Dual SIS for precise shifting throughout the range of 21 gears, and there's no fumbling to change gears; a flip of the Grip Shift puts you where you want to be.

**I**t all adds up to a nimble-riding, super-reliable machine that's as versatile as a bike can be.



Also available in Peacock Blue  
(men's and ladies')

Shimano 7-speed Hyperglide  
cassette- Wide range gearing  
for uphill or down.

GROSS

# APPROACH

New Avenir Comfort Plus Saddle- The best seat in the house.

## ◆ APPROACH ◆

**FRAME:** Hand welded CR-MO/High-Tensile steel mountain tubing.

**GROUP:** SHIMANO's new Altus derailleur and crankset with GRIP SHIFT™

**WHEEL SET:** American made Weinmann alloy rims with front and rear quick release.

**FEATURES:** DUAL SIS shifting, Avenir Comfort Plus saddle, and quick adjust seat clamp.

You're looking for a bike that's fun to ride, that allows you to sit upright in comfort, that's stable and easy to control, and still has the performance features of a much more expensive bike. The Approach is all this and much more. It gives you 18 gears — low ones for the hills, higher ones for fast and fun — and you can click into any of them with a simple wrist-twist of the Grip Shift. It also gives you a Comfort Plus saddle and alloy wheels, with quick-release hubs.

You may buy the Approach for its looks, but you'll love it for the ride.



Also available in Arctic Blue (men's and ladies')

# CROSS COUNTRY



**◆ CROSS COUNTRY ◆**

**FRAME:** Hand crafted High-Tensile steel frame.

**GROUP:** SHIMANO 18-speed SIS drivetrain with Hyperglide shifting.

**WHEEL SET:** American made light alloy rims with quick release front wheel.

**FEATURES:** Avenir COMFORT PLUS saddle, light alloy crankset and powerful brakes.

The Cross Country brings back the pleasure of the "good old days" of bicycling, when you sat upright and enjoyed the comfort of a patented Comfort Plus spring/gel saddle. But this is definitely a bike for today. Its Shimano Hyperglide shifting system allows you to click precisely and smoothly into gear. And with 18 gears to choose from, you can cruise in comfort wherever you ride. The alloy wheels are nice and light, and a convenient quick release means you can remove the front wheel in seconds to transport the bike with ease.

For fun or fitness, the Cross Country brings the old-fashioned pleasure of cycling into the '90s.

*Quick release front wheel makes transporting the bike easier.*

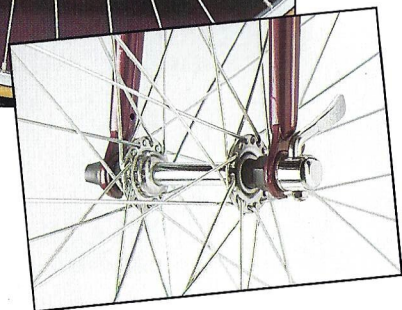

Also available in Emerald Black (men's).



Also available in Winter Mist (ladies').

R O A D

# PREVAIL TG

## ◆ PREVAIL TG ◆

FRAME: **TrueTemper** RCX double-buttet oversize CR-MO. Tange Prestige fork.

GROUP: **SHIMANO 800 ULTEGRA** 8-speed Hyperglide. Dual Control shifting.

WHEEL SET: Sun Metal M-14 Aero 32hole rims, butted stainless spokes, **MICHELIN** Hi-Lite Comp 20mm.

FEATURES: **SELLE ITALIA** Turbo saddle, SR alloy Modolo bend handlebar.

If you're serious about cycling, the Prevail TG is all you need to dominate the competition. Spinning out of turns, you'll taste the rocket-like acceleration of this exotic steel bike. This is the right stuff for serious racing: light and stiff True Temper RCX thermally enhanced oversize chromoly tubing, TIG-welded by hand, custom selected for each frame size. Shimano Ultegra STI brake levers put total control of both braking and shifting right at your fingertips. And the wheel set-up is just right for a jackrabbit bike: Sun Metal hard anodized aero rims, butted spokes and Michelin Hi-Lite Comp tires.

It's dialed in and ready to win: the very serious, very fast Prevail TG.



Shimano Ultegra Dual-Control STI levers- On the fly shifting performance.



# MASTER TG ▼



The bike's a beauty, sure, but that's not why we TIG-weld by hand its oversize, thinwall, thermally enhanced True Temper RC2 chromoly tubing. We do it to give you pulse-pounding acceleration, whether you're crossing the finish line with your hands in the air or topping out the toughest climb on a ride.

It looks great, but the proof is in the performance. Master the road with the Master TG.

## ♦ MASTER TG ♦

**FRAME:** True Temper RC2 double-butted oversized CR-MO. Taper gauge CR-MO Unicrown Super Radius fork.

**GROUP:** SHIMANO 105. Super SLR brakes, and clipless pedals.

**WHEEL SET:** Sun Metal M-14 Aero 32hole rims. Vittoria Zefir 22mm tires.

**FEATURES:** Zoom seat post. TIIGA Prestige stem.

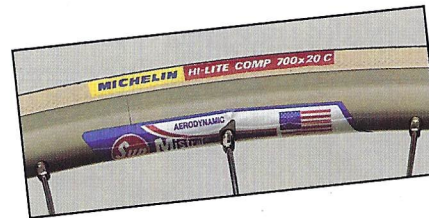

Light alloy rims and Vittoria tires- Smooth, light, and quick.

# EXPERT TG ▶

## ♦ EXPERT TG ♦

**FRAME:** True Temper RC2 double-butted oversized CR-MO. Taper gauge CR-MO Unicrown Super Radius fork.

**GROUP:** SHIMANO RX100 with Super SLR brake levers.

**WHEEL SET:** Sun Metal M-14 Aero 32hole rims. Vittoria Zefir 22mm tires.

**FEATURES:** AVENIR Gel saddle. SR "X" 90 degree alloy stem.

Here's a fast, light bike designed for real riders in the real world, where roads go up as often as down. The Expert TG features a triple crankset, so you have the "bail-out" gears to take on any hill that comes your way. This is no granny bike, though. The True Temper RC2 oversize chromoly tubing is the stuff of serious racing machines, and Shimano's RX-100 drivetrain and Exage EX dual-pivot brakes assure flawless performance.

Whether you're in hammer mode or spinning for distance, the Expert TG takes you as far and fast as your imagination ranges.



# SPECIFICATIONS

	CROSS				ROAD		
	Over Ride	Cross Campus	Approach	Cross Country	Prevail TG	MasterTG	Expert TG
<b>FRAME</b>	True Temper AVR special short butt, double butted CR-MO three main tubes. TIG welded. DB fastback forged drop-outs w/eyelets. Two water bottle mounts. Rack mounts.	CR-MO main tubes. TIG welded. DB fastback forged drop-outs w/eyelets. Two sets of water bottle mounts (mens), one set (ladies). Rack mounts.	CR-MO seat tube/High-Tensile top and down tubes. TIG welded. Two sets of water bottle mounts (mens), one set (ladies). Rack mounts.	Diamond Back / High-Tensile top and down tubes. TIG welded. Two sets of water bottle mounts, mens; One set, ladies.	True Temper RCX thermally enhanced, CR-MO special short butt oversized tubing. TIG welded. Braze-ons: shift lever bosses, pump peg, chain hanger, two sets of water bottle bosses. Forged alloy seat collar. Forged drop-outs.	True Temper RC2 thermally enhanced, CR-MO special short butt oversized tubing. TIG welded. Braze-ons: shift lever bosses, pump peg, chain hanger, two sets of water bottle mounts. Forged alloy seat collar. Forged drop-outs.	True Temper RC2 thermally enhanced, CR-MO special short butt oversized tubing. TIG welded. Braze-ons: shift lever bosses, pump peg, chain hanger, two sets of water bottle mounts, rear carrier mounts. Forged alloy seat collar. Forged drop-outs.
<b>FORK</b>	100% CR-MO Unicrown. TIG welded. Oval style blades w/eyelets and safety tips.	TIG welded. Unicrown oval blades w/eyelets and safety tips.	High-Tensile steel. TIG welded. Unicrown oval blades with eyelets and safety tips.	TIG welded unicrown oval blades. Fender eyelets and safety tips.	Tange Prestige Unicrown. Taper gauge CR-MO aero blades. 600mm radius bend. TIG welded.	Super Radius Unicrown. Taper gauge CR-MO blades. 600mm radius bend. TIG welded.	Super Radius Unicrown. Taper gauge CR-MO blades. 600mm radius bend. TIG welded.
<b>WHEELS</b>							
<b>RIMS</b>	Weinmann 2719 700C. Satin finish alloy.	Weinmann 2719 700C. Alloy, satin finish.	Weinmann 2115 700C. Alloy, satin 36H.	Weinmann 2115. Alloy, satin finished, 36H.	Sun Metal M14-A hard anodized. Aero profile.	Sun Metal M14-A hard anodized. Aero profile.	Sun Metal M14-A hard anodized. Aero profile.
<b>HUBS</b>	Shimano. Alloy, small flange, sealed. Freehub. QR 36H front and rear.	Shimano. Alloy, small flange, sealed freehub. QR 36H front & rear.	Small flange. QR 36H front and rear.	Small flange quick release front.	Shimano Ultegra. Alloy, small flange, sealed. Freehub. QR 32H F&R.	Shimano 105. Alloy, small flange, sealed. Freehub. QR 32H F&R.	Shimano RX 100. Alloy, small flange, sealed. Freehub. QR 32H F&R.
<b>SPOKES</b>	14ga. stainless.	14ga. UCP.	14ga. UCP.	14ga. UCP.	14/15/14G butted, stainless. Short nipple.	14ga stainless.	14ga stainless.
<b>TIRES</b>	Avenir Hill Street Cruise 700 x 41c skinnwall.	Cross Center Ridge 700 x 38c gumwall.	Cross Center Ridge 700 x 38c high density gumwall.	Cross Center Ridge 700 x 38c high density gumwall.	Michelin Hi-Lite Comp. 700 x 20mm, Presta valve.	Vittoria Zefir skinnwall. 700 x 22c. Presta valve.	Vittoria Zefir skinnwall 700 x 22c. Presta valve.
<b>DRIVETRAIN</b>							
<b>DERAILLEUR</b>	Rear - Shimano Altus A20. Front - Shimano Altus A20.	Rear - Shimano Altus C10 SIS. Front - Shimano Altus C10.	Rear - Shimano Altus C10. Front - Shimano Tourney TY21 Dual SIS.	Rear - Shimano Tourney SIS. Front - Shimano Tourney.	Rear - Shimano Ultegra, 8-speed. Front - Shimano Ultegra, clamp-on.	Rear - Shimano 105 SC. Front - Shimano 105 SC clamp.	Rear - Shimano RX 100, long cage. Front - Shimano RX 100 clamp-on, long cage.
<b>SHIFTERS</b>	New Grip Shift SRT-300.	New Grip Shift SRT 300.	New Grip Shift SRT 200.	Shimano Tourney SIS.	Shimano Ultegra STI. Dual Control levers.	Shimano 105 SC. Downtube braze-on.	Shimano RX 100. Downtube braze-on, triple.
<b>CHAIN</b>	DID Super Lannier.	Shimano Hyperglide.	Shimano Uniglide UG 50.	Shimano Uniglide UG 50.	Shimano CN-HG90. Narrow profile, silver.	Shimano CN-HG70. Narrow profile, silver.	Shimano CN-HG50. Narrow profile, silver.
<b>CRANKSET</b>	Shimano Altus A10 Dual SIS. 28/38/48. Cassette bottom bracket LP20.	Shimano Altus A20 Dual SIS 28/38/48T. Cassette bottom bracket CP20.	Shimano Altus CT20. Dual SIS. 24/38/48.	Sakae CFC alloy crank, 28/38/48T, Black finish.	Shimano Ultegra w/round Superglide 42/53T. Shimano Ultegra bottom bracket w/plastic inner sleeve.	Shimano 105 SC w/round Superglide 42/53T. Anatomically sized. 105 bottom bracket w/plastic inner sleeve.	Shimano RX 100 w/round Superglide 30/42/52T. Anatomically sized. Shimano bottom bracket w/plastic inner sleeve.
<b>FREEWHEEL COMPONENTS</b>							
<b>BRAKES</b>	Shimano Altus A20 multi-condition, low profile, alloy, cantilever front and rear.	Shimano Altus C10 SLR 3-finger brake levers. Multi-condition cantilever front & rear.	Shimano TY20 alloy cantilever front & rear. Three-finger alloy, brake levers.	Lee Chi alloy compact low profile cantilever front and rear.	Shimano Ultegra w/Super SLR. New STI brake levers.	Shimano 105 SC w/Super SLR aero levers.	Shimano Exage EX dual pivot calipers with Super SLR aero levers.
<b>PEDALS</b>	Victor Zytel resin, CR-MO axle, Tioga Sure Clips.	Victor Zytel resin. Boron axle.	Victor Zytel resin. Boron axle.	Victor Zytel resin, Boron axle.	Shimano 105 clipless. Two-position release. Alloy.	Shimano 105 clipless. Two-position release. Alloy.	Shimano RX 100. Integral Shimano resin clip, reinforced nylon strap.
<b>HEADSET</b>	DB Black finish.	DB Black finish.	DB Black finish.	DB Black finish.	Shimano Ultegra.	Shimano 105.	Tange Seiki Levin CD. Alloy, black finish.
<b>SEAT POST</b>	Avenir alloy, micro-adjust. 300mm. Q.R. seat post clamp.	Avenir alloy. 300mm. Q.R. seat post clamp.	Satin finish, steel. Q.R. seat post clamp.	Satin finish, steel.	Zoom CR-MO. Micro-adjust. Titanium finish.	Zoom CR-MO. Micro-adjust. Titanium finish.	Kalloy. Alloy, micro-adjust.
<b>SEAT</b>	Avenir "Comfort Plus", patent pending spring saddle. Emerald cover with Gel-lite.	Avenir "Comfort Plus", patent pending spring saddle. Emerald cover with Gel-lite.	Avenir "Comfort Plus" patent pending spring saddle. Emerald cover with Gel-lite.	Avenir "Comfort Plus" patent pending spring saddle. Emerald cover with Gel-lite.	Vetta Racing Turbo. Made in Italy.	Vetta Racing Turbo. Made in Italy.	Avenir Racing Gel. Emerald cover.
<b>HANDLEBAR</b>	Avenir alloy, flat 6" bend.	DB mid-rise cross bar with 6" bend.	DB mid-rise cross bar with 6" bend.	DB mid-rise cross bar with 6" bend.	SR Alloy Modolo bend w/cable groove. Anatomically sized.	SR Alloy Modolo bend w/cable groove. Anatomically sized.	SR Alloy Modolo bend w/cable groove. Anatomically sized.
<b>STEM</b>	"Zoom Cross". TIG welded. Anatomically sized.	DB TIG welded. Anatomically sized. Cross rise.	DB TIG-welded steel. Anatomically sized. Cross rise.	DB TIG welded. Anatomically sized. Cross rise.	Tioga Prestige T-Bone. Anatomically sized.	Tioga Prestige T-Bone. Anatomically sized.	SR "X" stem. 90° bend, alloy. Anatomically sized.
<b>SIZES</b>	Mens: 15", 17", 19", 21".	Mens: 15", 17", 19", 21"; Ladies: 16", 19".	Mens: 15", 17", 19", 21"; Ladies: 16", 19".	Mens: 17", 19", 21"; Ladies: 16", 19".	46, 48, 50, 52, 54, 56, 58, 60, 62cm (center to center).	46, 48, 50, 52, 54, 56, 58, 60, 62cm (center to center).	46, 48, 50, 52, 54, 56, 58, 60, 62cm (center to center).
<b>COLORS</b>	Emerald Black.	Mens & Ladies: Metallic Black, Peacock Blue.	Mens and Ladies: Granite Silver, Arctic Blue.	Mens: Emerald Black, Black Cherry. Womens: Black Cherry, Winter Mist.	Deep Purple.	White w/Blue Splash.	Midnight Red.

All frames finished with protective clear coat. All models meet or exceed CPSC standards for bicycles. Specifications subject to change without notice. U.S. market specifications listed - Specifications may vary in other countries.

Diamond Back bicycles carry a lifetime warranty. Check with your dealer for details.

# Service

Diamond Back bicycles are sold exclusively through professional bicycle dealers coast-to-coast, nationwide, and throughout the world. Any Diamond Back dealer will honor our warranty, and will provide expert customer service anywhere you happen to be.

All bikes are designed, equipped, and sold assembled by an authorized dealer to meet or exceed consumer product safety commission guidelines and regulations.

Since components are sourced on a world-wide bases, all specifications are subject to change without notice.

# Warranty

Every Diamond Back bicycle is built to exacting specifications, and is the product of carefully planned manufacturing and assembly.

WSI, Inc., guarantees your satisfaction through our Lifetime Limited Warranty on frame and fork, and a one-year warranty on components. Those models equipped with Marzocchi suspension have a separate, two-year suspension warranty. See your owner's manual for more details on your Diamond Back warranty.



## DIAMOND BACK



Printed on Recycled Paper

Diamond Back, DBR, Avenir and Preference are registered tradenames of WSI California. © 1993 WSI.

	C R O S S					R O A D							
	FRAME SIZE	TOP TUBE	SEAT TUBE	CHAIN STAY	FORK OFFSET	WHEEL BASE	B.B. HEIGHT	HEAD ANGLE	SEAT ANGLE	STAND HEIGHT	STEM LENGTH	CRANK LENGTH	BAR WIDTH
Over Ride	15"	21.5"	15"	17.3"	1.8"	41.3"	11.2"	71°	73°	28.5"	110mm	170mm	600mm
	17"	22"	17"	17.3"	1.8"	41.4"	11.2"	72°	73°	29.5"	110mm	170mm	600mm
	19"	21.7"	19"	17.3"	1.8"	42"	11.2"	72°	73°	30.9"	130mm	170mm	600mm
	21"	23.6"	21"	17.3"	1.8"	42.7"	11.2"	72°	73°	32.2"	130mm	170mm	600mm
Cross Campus	15"	21.5"	15"	17.3"	1.8"	41.3"	11.2"	71°	73°	28.5"	110mm	170mm	600mm
	17"	22"	17"	17.3"	1.8"	41.4"	11.2"	72°	73°	29.5"	110mm	170mm	600mm
	19"	21.7"	19"	17.3"	1.8"	42"	11.2"	72°	73°	30.9"	110mm	170mm	600mm
	21"	23.6"	21"	17.3"	1.8"	42.7"	11.2"	72°	73°	32.2"	130mm	170mm	600mm
	L-16"	22.9"	16"	17.3"	1.8"	41.4"	11.2"	72°	73°	26.8"	80mm	170mm	600mm
	L-19"	23.4"	19"	17.3"	1.8"	42"	11.2"	72°	73°	26.8"	110mm	170mm	600mm
Approach	15"	21.5"	15"	17.3"	1.8"	41.3"	11.2"	71°	73°	28.5"	110mm	170mm	600mm
	17"	22"	17"	17.3"	1.8"	41.4"	11.2"	72°	73°	29.5"	110mm	170mm	600mm
	19"	21.7"	19"	17.3"	1.8"	42"	11.2"	72°	73°	30.9"	110mm	170mm	600mm
	21"	23.6"	21"	17.3"	1.8"	42.7"	11.2"	72°	73°	32.2"	130mm	170mm	600mm
	L-16"	22.9"	16"	17.3"	1.8"	41.4"	11.2"	72°	73°	26.8"	80mm	170mm	600mm
	L-19"	23.4"	19"	17.3"	1.8"	42"	11.2"	72°	73°	26.8"	110mm	170mm	600mm
Cross Country	17"	22"	17"	17.3"	1.8"	41.4"	11.2"	72°	73°	29.5"	110mm	170mm	600mm
	19"	21.7"	19"	17.3"	1.8"	42"	11.2"	72°	73°	30.9"	110mm	170mm	600mm
	21"	23.6"	21"	17.3"	1.8"	42.7"	11.2"	72°	73°	32.2"	110mm	170mm	600mm
	L-16"	22.9"	16"	17.3"	1.8"	41.4"	11.2"	72°	73°	26.8"	80mm	170mm	600mm
	L-19"	23.4"	19"	17.3"	1.8"	42"	11.2"	72°	73°	26.8"	110mm	170mm	600mm
	Prevail TG	46cm	520mm	460mm	410mm	50mm	991mm	288mm	72°	74.5°	754mm	230mm	165mm
48cm		525mm	480mm	410mm	50mm	991mm	285mm	72°	74.5°	762mm	230mm	165mm	390mm
50cm		540mm	500mm	410mm	45mm	995mm	280mm	72.5°	74.5°	776mm	230mm	165mm	390mm
52cm		546mm	520mm	410mm	45mm	992mm	270mm	73°	74.5°	785mm	230mm	170mm	390mm
54cm		560mm	540mm	410mm	45mm	1002mm	270mm	73°	73.9°	805mm	230mm	170mm	390mm
56cm		570mm	560mm	410mm	40mm	992mm	270mm	73.5°	73°	820mm	230mm	170mm	410mm
58cm		585mm	580mm	410mm	40mm	1007mm	270mm	73.5°	73°	839mm	230mm	172.5mm	410mm
60cm		590mm	600mm	410mm	40mm	1012mm	270mm	73.5°	73°	858mm	230mm	172.5mm	430mm
62cm		590mm	620mm	410mm	40mm	1001mm	270mm	74.5°	73°	877mm	230mm	175mm	430mm
Master TG		46cm	520mm	460mm	410mm	50mm	991mm	288mm	72°	74.5°	754mm	230mm	165mm
	48cm	525mm	480mm	410mm	50mm	991mm	285mm	72°	74.5°	762mm	230mm	165mm	390mm
	50cm	540mm	500mm	410mm	45mm	995mm	280mm	72.5°	74.5°	776mm	230mm	165mm	390mm
	52cm	546mm	520mm	410mm	45mm	992mm	270mm	73°	74.5°	785mm	230mm	170mm	390mm
	54cm	560mm	540mm	410mm	45mm	1002mm	270mm	73°	73.9°	805mm	230mm	170mm	390mm
	56cm	570mm	560mm	410mm	40mm	992mm	270mm	73.5°	73°	820mm	230mm	170mm	410mm
	58cm	585mm	580mm	410mm	40mm	1007mm	270mm	73.5°	73°	839mm	230mm	172.5mm	410mm
	60cm	590mm	600mm	410mm	40mm	1012mm	270mm	73.5°	73°	858mm	230mm	172.5mm	430mm
	62cm	590mm	620mm	410mm	40mm	1001mm	270mm	74.5°	73°	877mm	230mm	175mm	430mm
	Expert TG	46cm	520mm	460mm	410mm	50mm	991mm	288mm	72°	74.5°	754mm	230mm	165mm
48cm		525mm	480mm	410mm	50mm	991mm	285mm	72°	74.5°	762mm	230mm	165mm	390mm
50cm		540mm	500mm	410mm	45mm	995mm	280mm	72.5°	74.5°	776mm	230mm	165mm	390mm
52cm		546mm	520mm	410mm	45mm	992mm	270mm	73°	74.5°	785mm	230mm	170mm	390mm
54cm		560mm	540mm	410mm	45mm	1002mm	270mm	73°	73.9°	805mm	230mm	170mm	390mm
56cm		570mm	560mm	410mm	40mm	992mm	270mm	73.5°	73°	820mm	230mm	170mm	410mm
58cm		585mm	580mm	410mm	40mm	1007mm	270mm	73.5°	73°	839mm	230mm	172.5mm	410mm
60cm		590mm	600mm	410mm	40mm	1012mm	270mm	73.5°	73°	858mm	230mm	172.5mm	430mm
62cm		590mm	620mm	410mm	40mm	1001mm	270mm	74.5°	73°	877mm	230mm	175mm	430mm

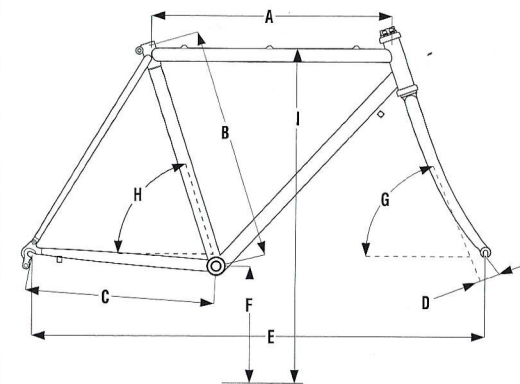

- A- Top Tube
- B- Frame Size/  
Seat Tube
- C- Chain Stay
- D- Fork Offset
- E- Wheel Base
- F- Bottom Bracket  
Height
- G- Head Angle
- H- Seat Angle
- I- Stand Over  
Height

Note: Frame Size/Seat Tube dimensions are center-to-top on all mountain and cross models, and center-to-center on all road models.

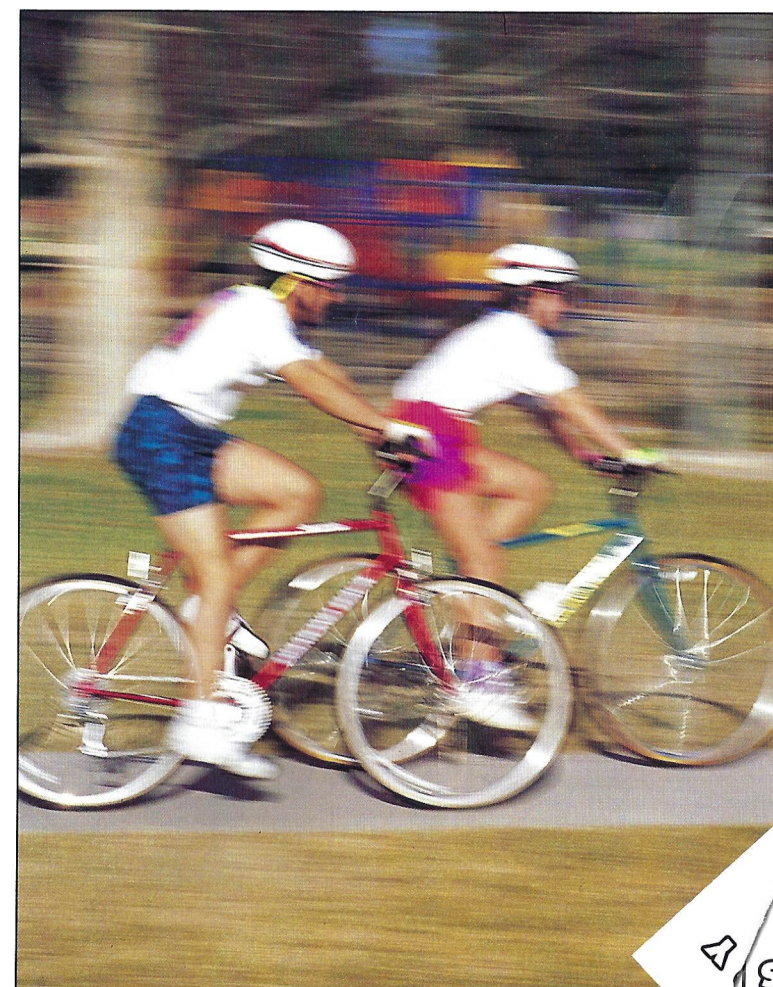

- Ride only on open trails.
- Never spook animals.
- Control your bicycle.
- Always yield trail.
- Leave no trace.
- Plan ahead.

WSI supports IMBA and its trail efforts. When riding off-road please do your part by observing the following guidelines:

**D**iamond Back suggests that you always wear an ANSI or SNELL approved helmet, such as the Avenir Event, while riding. Please ride safely and be prepared for eventualities that might occur. Please remember that the roads and trails must be shared, please ride courteously.