

# SUNTOUR

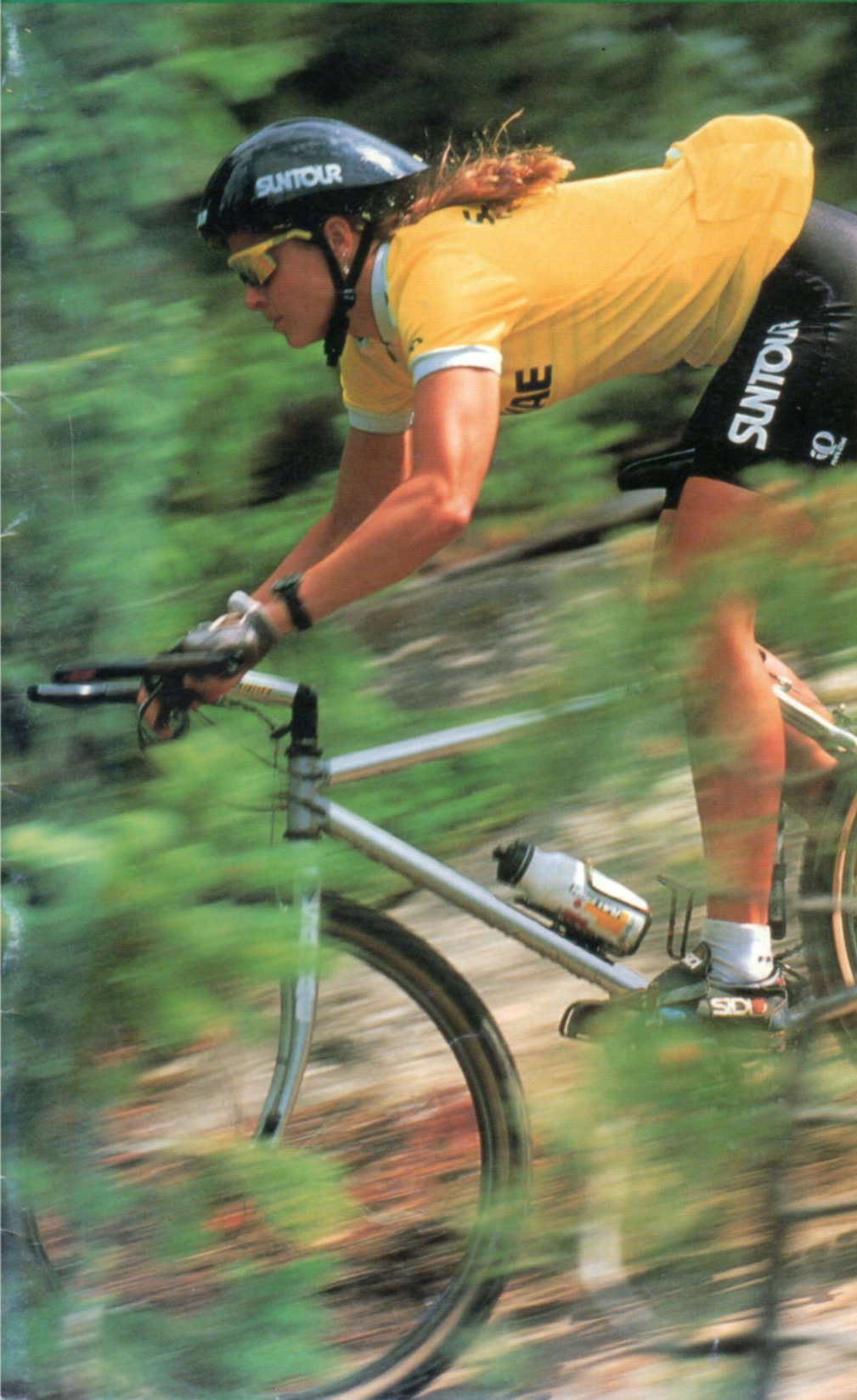

## 1992 BICYCLE EQUIPMENT CATALOG

ENGLISH



# *Lighter, Stronger, Smoother, Safer*

Human powered, the bicycle must be light in weight. The concept of weight reduction is an inherent part of cycling. SUNTOUR has produced bicycle parts for many years based on this simple truth.

At SUNTOUR light-weight never means a sacrifice in strength. Designs that avoid wasted rider energy and effort combined with cold forging produces components unequalled in strength and beauty. Cold forged aluminum alloy is today's finest material for the production of bicycle components. An example of this is the Microlite series of components that utilizes cold forged alloy where other components use steel. As a result XC-Pro and Superbe Pro groups stand out as the very top class in terms of performance and light-weight.

Another basic function that SUNTOUR attaches great importance to is rotational performance. This is evident from the use of cartridge bearings in Superbe Pro and XC-Pro components. Cartridge bearings yield a super-smooth feel because of their design and offer far lower rolling resistance than other types of bearing systems found on bicycle parts. An additional feature is the patented relubrication system that SUNTOUR has integrated into its components. For the first time, cartridge bearings can be serviced regularly without risk of damage to increase longevity and enhance performance. In both XC-Pro and Superbe Pro SUNTOUR utilizes more cartridge bearings than any other component manufacturer.

Combining superior materials and manufacturing methods with advanced mechanical technology and innovative thought produces lightweight functional components that allow the riders to realize their full potential. New for 1992, the Micro Drive drivetrain option is an example of this directive, reduced weight and high function. Utilizing PowerFlo (also found throughout the line), SUNTOUR's newly designed shifting system gives all riders accurate shifts under pressure without compromise.

Producing components that maximizes the riders potential,

Lighter, stronger, smoother, safer.





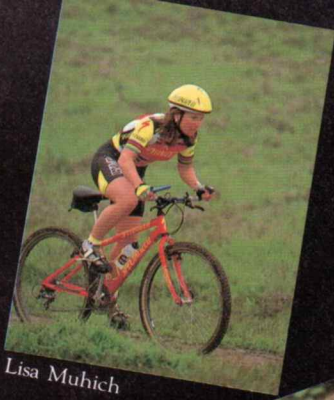

Lisa Muhich

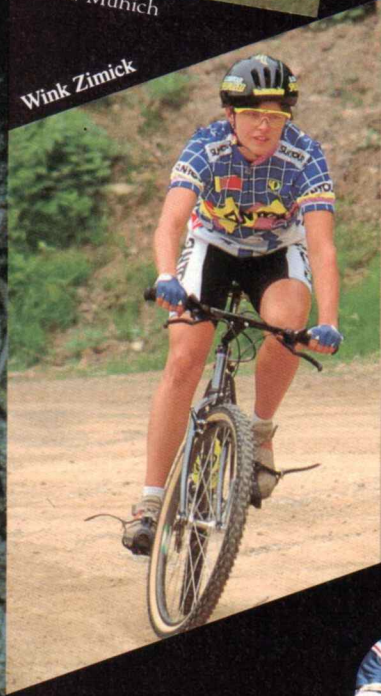

Wink Zimick

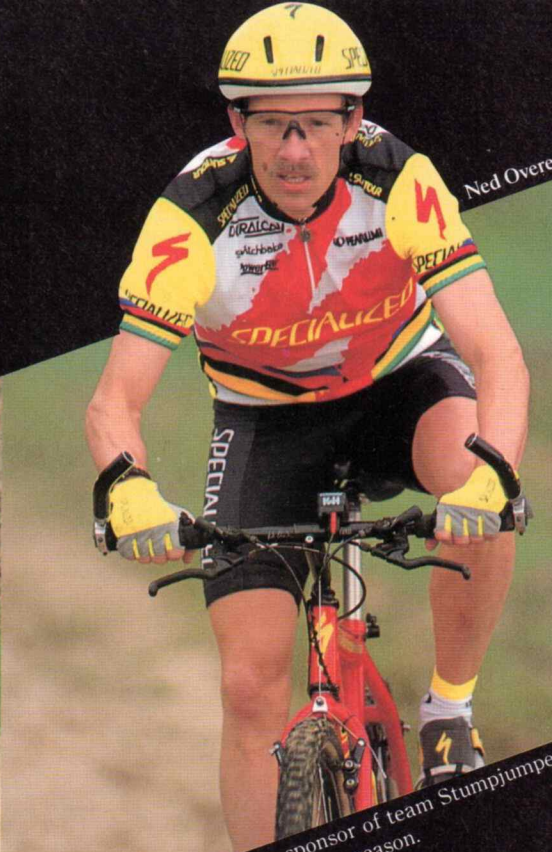

Ned Over

Official component sponsor of team Stumpjumper for the 1991 MTB racing season.

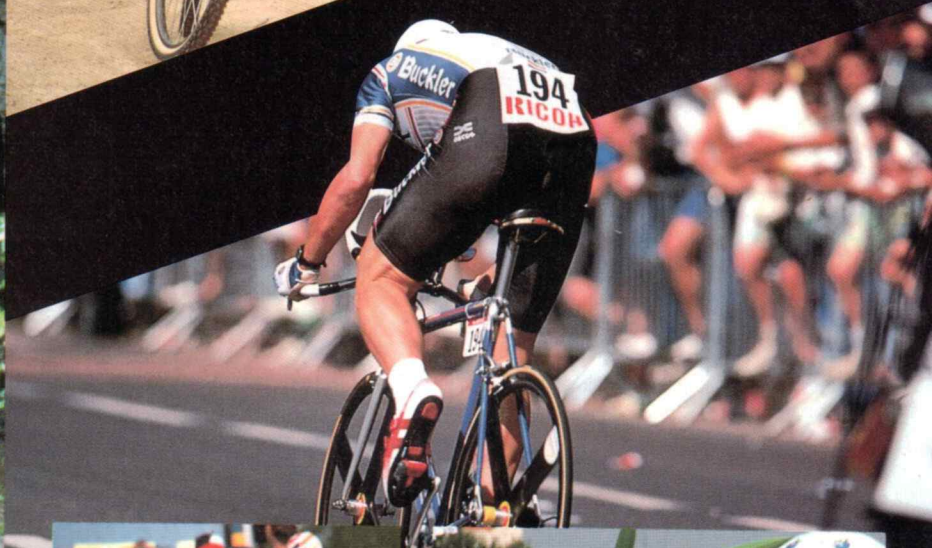

### Catalog/INDEX

- Page 2 ~ 8/Features
- Page 9 ~ 18/ATB & Hybrid Components
- Page 19 ~ 26/Road Components
- Page 27 ~ 29/SUNTOUR Options & Accessories

Photo/'91 TOUR DE FRANCE.



Ned Overend



# FEATURES

Accushift Plus For fast, accurate shifting

*Lighter, Stronger, Smoother, Safer*  
**ACCUSHIFT PLUS**

Shifting often means changing gears under pressure or shifting by reflex. SUNTOUR's Accushift Plus system allows smooth, solid shifts with new-design PowerFlo cogs. Light weight, ergonomic shifter options combined with PowerFlo allows the rider to maximize his shifting efficiency without compromising control through true compatibility.

'92NEW

**XCPRO MD**

*High performance  
Light Weight*



Smallest rings and gears: by reducing the diameter of the chainring bolt circle diameter on the crank arm, SUNTOUR is able to replace the standard 46/36/24 (or 48/28/28) with a compact 42/32/20 on the front chainrings. This has also allowed us to reduce the 7 rear gears to a 11-24 tooth range.

Beside a dramatic loss in weight, this reduction in overall drive train size has several advantages that will enhance the potential of any bike.

Most of the parts making up the drive train have been reduced in size: Chain rings and the 7-speed cassette have been reduced; the shaft of the bottom bracket has been shortened, utilizing all new low profile crank arms; a short cage rear derailleur has been adopted; and a shorter chain is being used. All of these reductions in size also mean a reduction in weight.

\*XC-Pro components, already recognized as the world's lightest, have undergone further weight reduction.



# MD USEFULL GEAR TABLE

## GEAR RATIO COMPARISON CHART OF "MD" AND CONVENTIONAL MODEL

Gear ratio	3.8	3.6	3.4	3.2	3	2.8	2.6	2.4	2.2	2	1.8	1.6	1.4	1.2	1	0.8	
MD CW: 42-32-20T FW: 11-24T																42T	
Conventional Model CW: 46-36-24T FW: 12-28T																46T	
																36T	
																24T	

**XC COMP MD**

*Compact size*



11T COG

### 1. Increased frame clearance ; more space for bigger tires

The smaller diameters of the front chain rings mean increased clearance at the chainstays. This increased space means that the width of chainstays can be increased, improving tire clearance. This extra space also means that chainstay dimpling can be reduced or eliminated. The 20t inner ring fits over the bottom bracket shell, so chain jam is virtually eliminated.

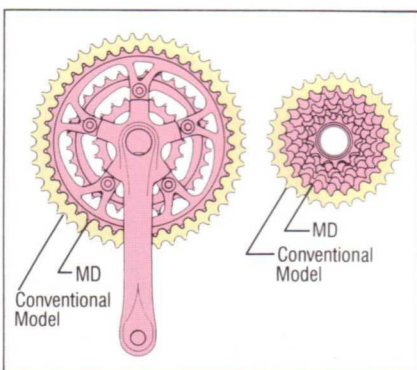

### 2. Faster, smoother shifts

With a 11-24 seven speed cassette and a short cage rear derailleur on the back, shifting is fast ; smaller jumps between gears means less chain travel, quicker response.

### 5. Low-profile cranks

Cold forged for light weight and high strength the newly designed MD cranks offer a lower profile for more efficient pedaling as well as Low-Q-Factor concept. Another benefit of the lower profile is the reduce length of the bottom bracket spindle resulting in lower weight.

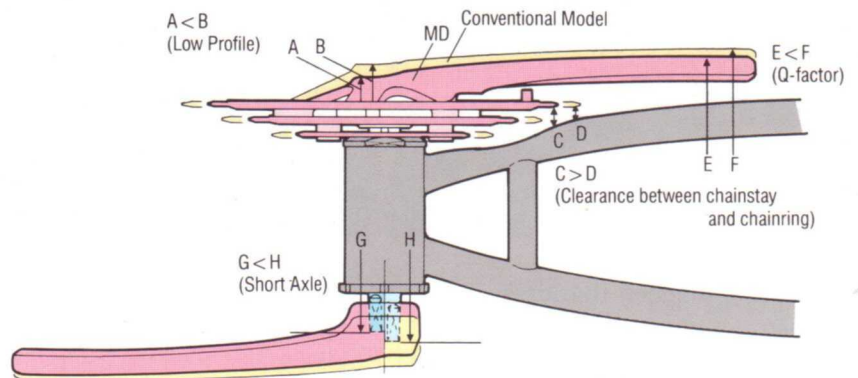

### 3. Increased ground clearance

Reducing the size of the chain rings has also increased ground clearance significantly, allowing riders to negotiate obstacles with less chance of damage to their equipment.

### 6. No more chain jam

The 20 tooth inner chainring overlaps the bottom bracket shell with a minimum amount of clearance. As a result of the close tolerances, the chain can no longer jam between the bottom bracket spindle and the shell.

### 4. More efficient gearing

The number of overlapping gear ratios has been reduced in comparison to standard 7 speed drive train systems. Less duplication of ratios means more gear combinations that make MD comparable to 8-speed systems.



'92NEW

## POWERFLO

### Smooth, fast shifts



CS-AP20-S7

PowerFlo enhances the interface between chain cog, enabling smooth, quick shifts even under heavy loads. PowerFlo incorporates specially beveled cogs that are preceded by a leading-edge notch in strategic teeth to help lift the chain to the next gear, at the same time lowering the level of lateral stress on the chain.

All new, the bushingless chain is designed specially for use with PowerFlo and other SUNTOUR systems. The new chain features a redesigned side plate that enhances the performance of the system. Laterally stiff, the bushingless design allows a lower profile than standard chains so that it will engage the gear quicker.

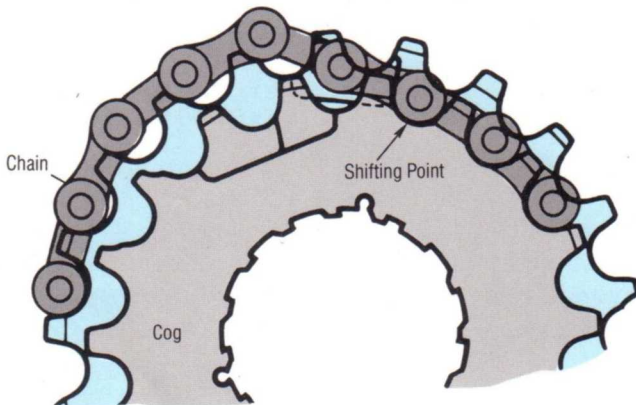

'92NEW

## WISHBONE

### New Ergonomic simplified shift



Like the Top Mount shifter, the Wishbone features simple operation but mounted under the handlebar.

The Wishbone shift lever shares the same simple operation as our standard top mount shifter, but it's mounted under the bar. Designed for use on flat bars, the Wishbone features a unique Y-shaped lever that allows the riders to make shifts ergonomically without removing their hands from the grips. Light-weight alloy construction with rubber lever ends, the Wishbone shifter lever features Multi-Mount positioning, making personalized ergonomic placement of controls possible for the rider.

- Aluminum construction
- Ergonomic design
- Light index mode
- Rubber-covered lever ends

## MULTI MOUNT

*Ideal positioning for both brake and shift levers*

The SUNTOUR Multi Mount system gives mountain bike riders true brake and shift lever positioning flexibility. Constructed of light weight alloy, these narrow profile, durable clamps allow cyclists the option of installing their shift levers inside or outside of the brake levers. Angles are independently adjustable, so the rider can position the controls for a better fit. More effective positioning means better control and less fatigue for your hands.



# ONE SHIFTER

## ic Design, fting



SL-XP20-R7

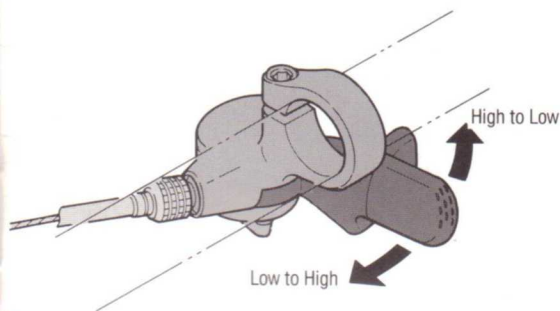
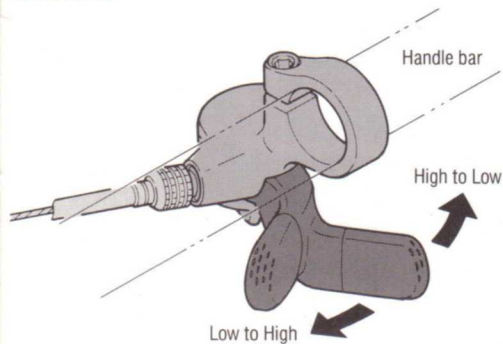

THUMB SHIFTER WITH MULTIMOUNT

'92NEW

# HYBRID-BIKE COMPONENTS

## FSE/XCM/XCT



### FSE/XCM/XCT Fitness components; the best of both worlds

Combining the rugged construction of our light-weight off-road parts with the elegance and finish found on our best road parts, and you get hybrid components that are both attractive and truly functional.

### FSE

This lineup is available on '92 hybrid bikes. Their light-weight, functional design and attractive appearance has been designed to enhance the function and appearance of any Hybrid/Fitness-model.

- Light operation shifting system for easier shifting
- New command-type shifter for drop style handlebars. For flat handlebars, depending on style, riders can choose between the New Wishbone design, X-Press or Top Mount shift levers.
- Brake levers are available for both flat or drop bars

- Two available front gearing choices: 50/40/28 or 52/42/32
- New triple-pivot brake caliper. (Cantilever-type brakes also available)

### XCM · XCT

XCM and XCT can be found on both mountain and hybrid bike models.

- Light operation shifting system for easier shifting
- New command type shifter for drop style handlebars. For flat handlebars, depending on style, riders can choose between the New Wishbone design, X-Press or Top Mount shift levers.
- Two available front gearing choices: 48/38/28 (for mountain bikes) or 50/40/28
- Choice of cantilever or side pull brakes



'92NEW

## LITE OPERATION

### Easier, more comfortable shifting

Ideal for casual use bicycles, this system is achieved by lightening the action of the return spring on the front and rear derailleurs. The shift lever has been given a lighter feel as well. As a result, shift action is so light it takes only half the effort of a conventional system. This system is best suited to casual riders. Models compatible with light operation shifting system include XCM/XCT/XCU/FSE/BLAZE/VX/RT and Scrambler (standard specifications as per the SUNTOUR '92 components catalog).

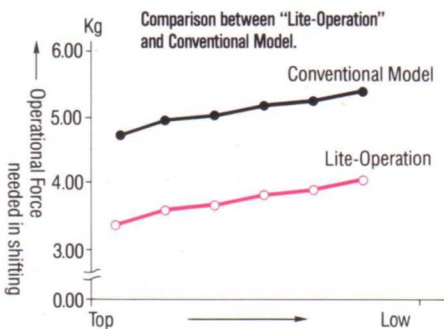

In order for the Light Operation system to function properly, it is recommended that the set consists of the proper front and rear derailleurs and shift levers.



'92NEW

## COMMAND

### shift on the fly



New Command shifters allow the rider to shift whether in the saddle, standing on a climb, or in a sprint. Mounted inboard of the brake levers, their ergonomic design allows the cyclist to push the lever with their finger or with their thumb for up and down shifting when they need it most. Light-weight and durable the Command shift levers are protected from impact by the handle bars and brake levers.

- New compact, light-weight design
- Light index setting
- Adjustable positioning
- Easy installation

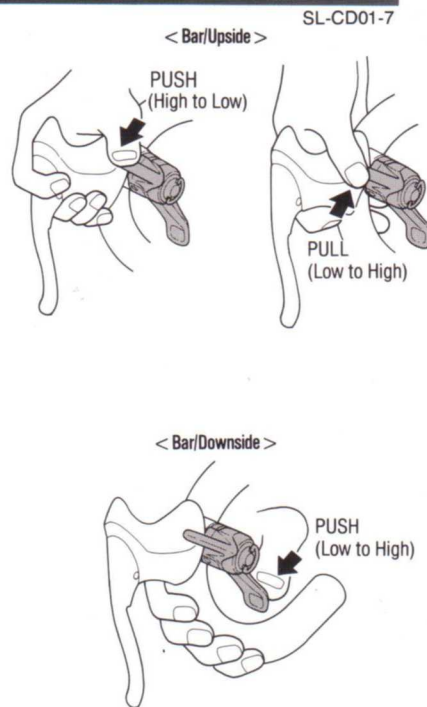



'92NEW

SE

## Super-Low-Profile SE Cantilevers

### 20% increase in braking performance

Super Low-Profile Self Energizing brakes use the directional force of the rim to increase braking energy. As the pads contact the rim they are pulled forward toward the seatstay: the brake's internal helical mechanism drives the pads onto the rim with greater force.

Compact, the new SE Low-Profile has an all new, low profile design that tucks the brake arms out of the way for greater heel clearance and less chance of impact.

- Reduced Weight, Light action operation
- New brake shoe design for increased stopping power



CT-XP11

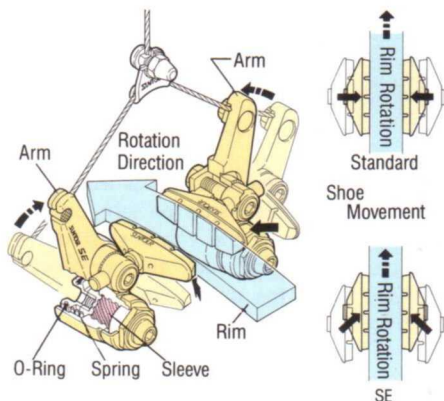

## CARTRIDGE BEARING

### The least rolling resistance

Utilizing extremely high precision machining technology, the "contact surface" of the balls inside the bearing are machined within a tolerance of 0.001 millimeter. Under load, rotational resistance is reduced to less than half that of standard bearing systems. Replacement and adjustment of this system is very easy and double seal mechanism completely isolates the bearings from impurities.

Utilized extensively in Superbe Pro and XC-Pro components, cartridge bearings for the first time are also serviceable through the developments of SUNTOUR's lubrication system.

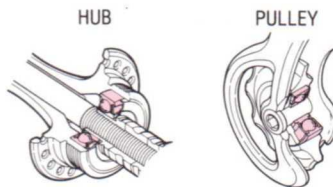

ROTATIONAL RESISTANCE UNDER LOAD  
Cartridge Bearing Hub/Conventional Hub

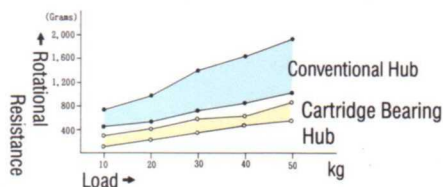

## MICROLITE

### Redefining light-weight

BB-SL10-E  
FH-SL10-7  
HB-SL10-F



A component upgrade option for those in who count their grams, Microlite components offer weight savings of almost a half-pound! Where standard front hubs have a steel axle, bottom brackets have steel cups and freehubs have steel bodies, SUNTOUR Microlite replaces these parts with aluminum. The end result, Micro-light!

Aluminum alloy parts which are used in place of conventional steel parts are indicated in blue.

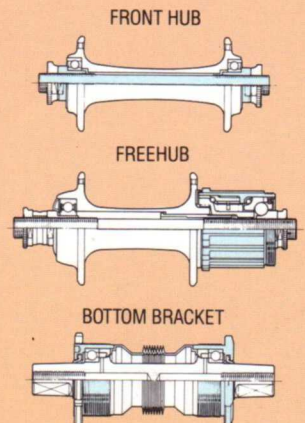



**GREASE GUARD**



# WTB SUNTOUR GREASE GUARD INTRODUCING THE 30 SEC. OVERHAUL!



Keeping your bike in tiptop shape has never been easier. The new WTB/SUNTOUR Grease Guard System lets you clean and lube your hub, bottom bracket, headset and pedals in just a matter of seconds. It's simple. As you inject new WTB/SUNTOUR grease into the convenient injection ports, you purge out the used and contaminated grease. In just seconds you've overhauled your bike's most critical parts : the hub, bottom bracket, headset and pedal bearings. There's no better way to keep your bike performing at its very best.

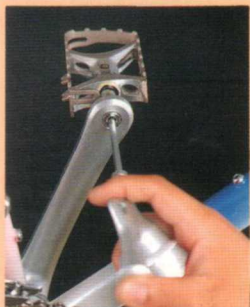
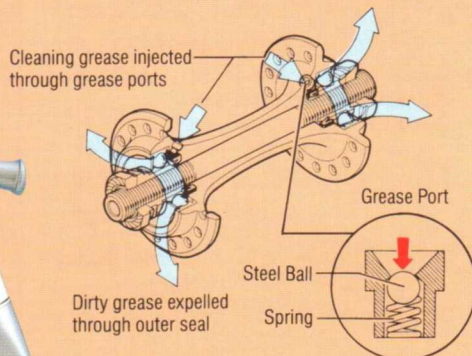

OT-GG11

**X-PRESS**

*Positive shifting without changing your grip*



X-Press shift levers let the rider shift without compromising braking or steering control. Mounted under the bar, X-press shift levers have a streamlined, uncluttered look and can be adjusted to fit the individual riders most comfortable hand position.

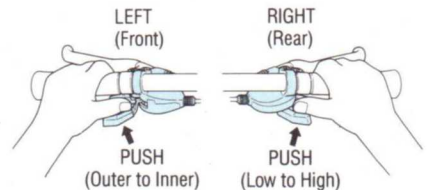

**POWERING**

*Smooth shifts, reduced chain-suck*

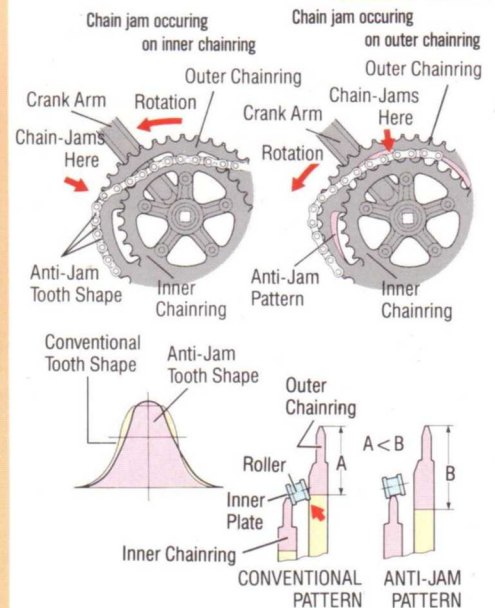

Specially shaped teeth, combined with a specially profiled side pattern on the chainrings, help the chain shift down without hanging up and jamming. Mounted to the outer chainring is an anti-jam pin, which keeps the chain from getting jammed between the crank arm and the chainring.



**All**

**Terrain**

**Bike & Hybrid**

**Bike**

< COMPONENTS >

- XC-PRO <MD>
- XC-PRO
- XC-COMP <MD>
- XC-COMP
- XC-LTD
- X-1
- FS-E
- XCE
- XCM
- XCT
- XCU

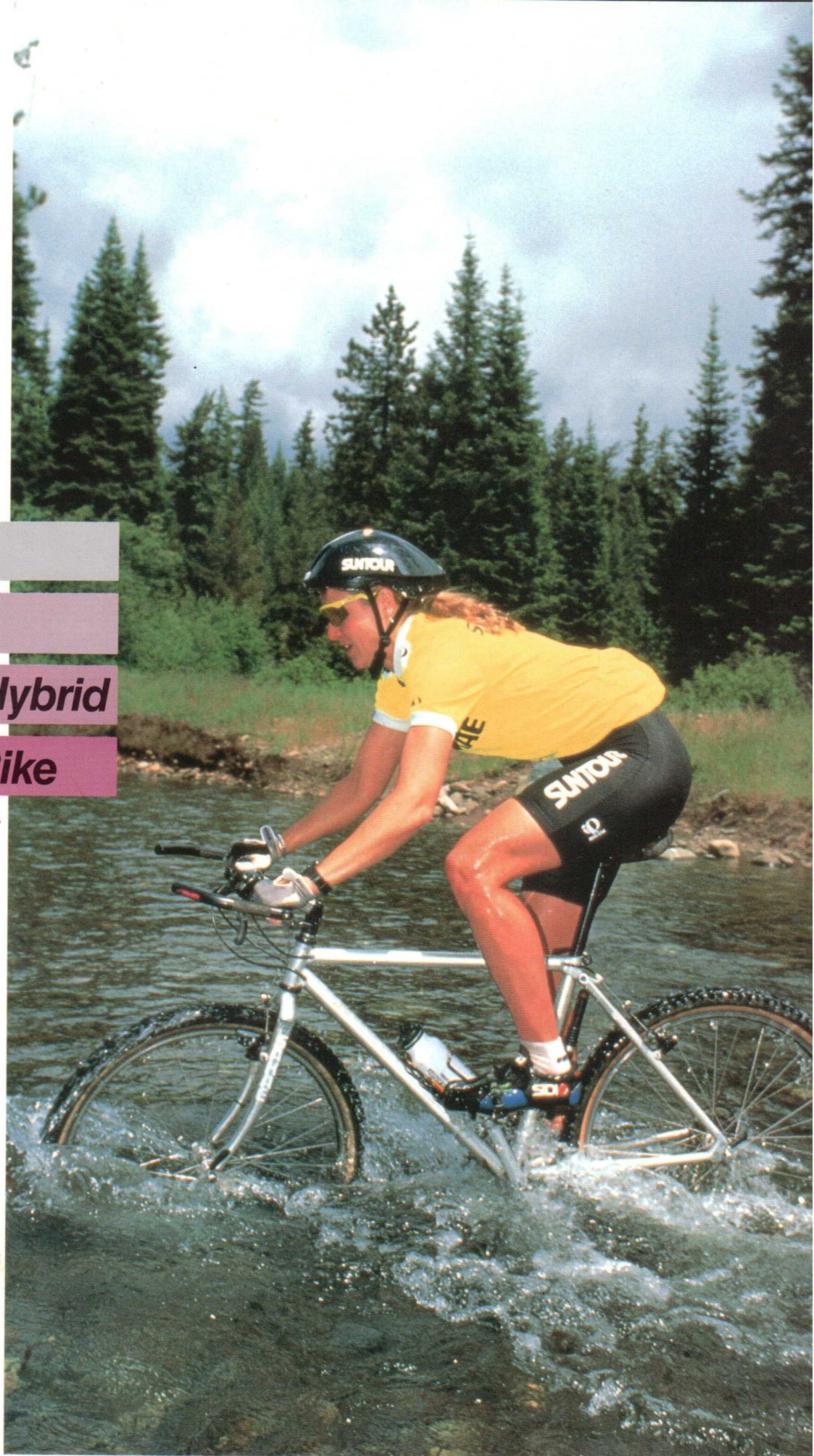



# SUNTOUR XC PRO **MD** & SUNTOUR XC PRO

*The state of the art from SUNTOUR*

XC-Pro incorporates the highest-quality materials and manufacturing processes with state-of-the-art drivetrain and component technology. Engineered for strength and durability, XC-Pro components are the lightest weight in their class.

**MD  
POWERFLO  
WISHBONE SHIFTER  
SE  
CARTRIDGE BEARING  
GREASE GUARD  
X-PRESS  
POWERING**

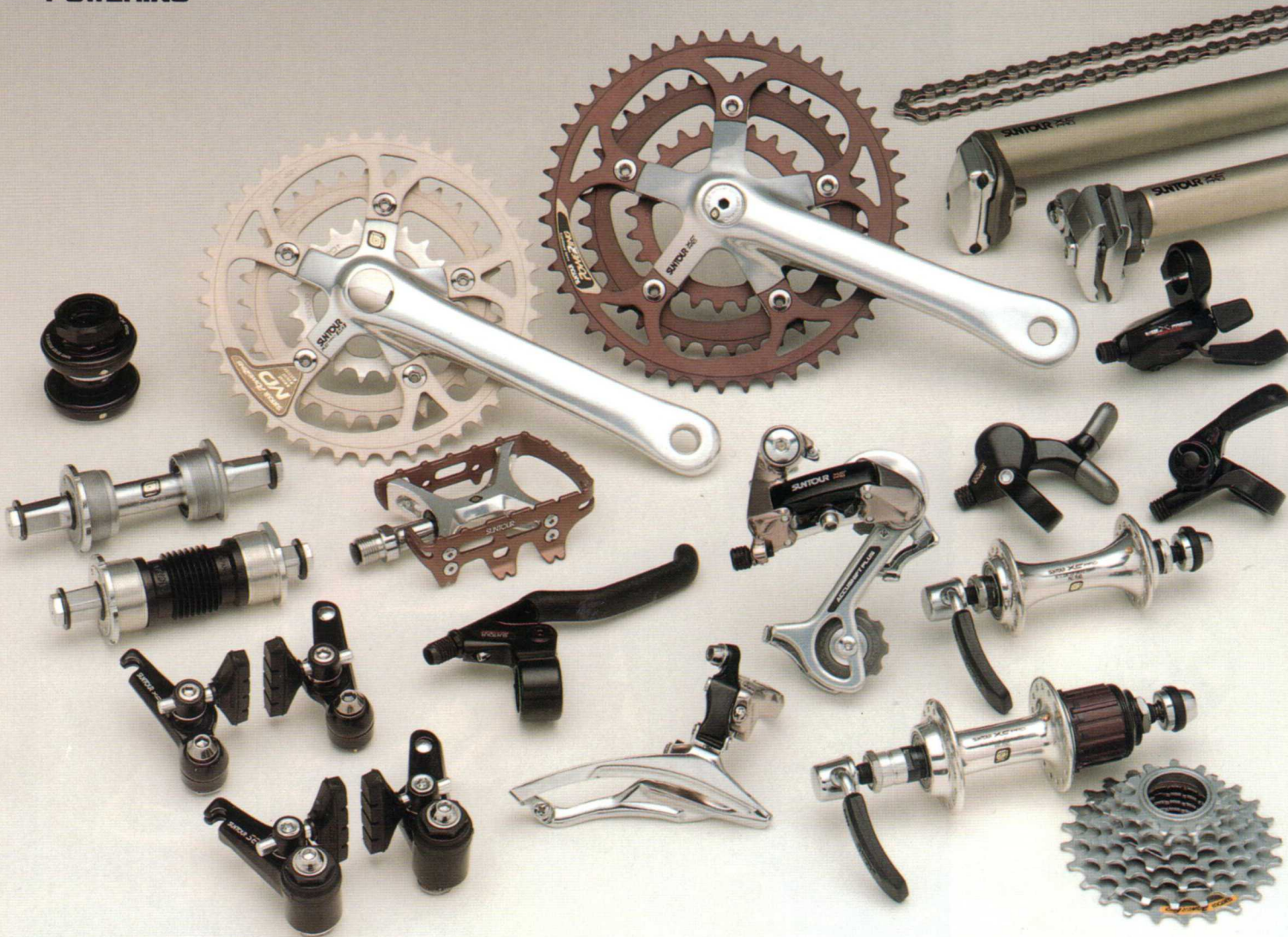

The new XC-Pro pedal has been refined and upgraded for easier foot placement and pedalling. (adapted Grease Guard System.)





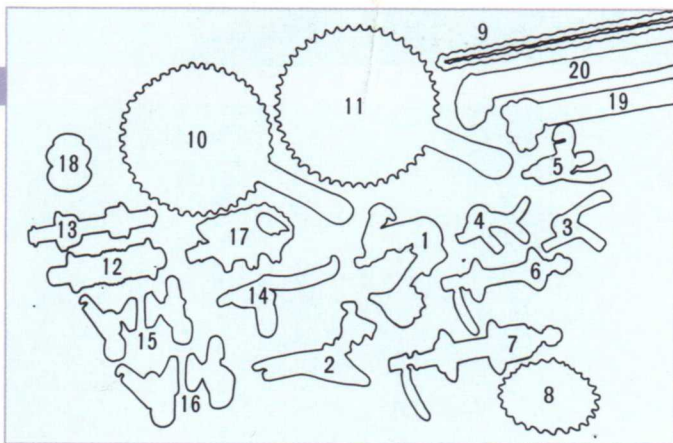

### 1 REAR DERAILLEUR

Model: RD-XP00-GXB  
(Code No. 24039921) (GX Type)  
Model: RD-XP00-GTB  
(Code No. 24029921) (GT Type)  
Model: RD-XP00-SSB  
(Code No. 24019921) (SS Type)

#### Specifications

- **ACCUSHIFT PLUS Compatible**
- **Largest rear cog:**  
30T (28mm dropout) (GX & GT)  
28T (28mm dropout) (SS)
- **Total gear capacity:**  
GX: J9T (Maximum chainring differential: 22T)  
GT: 34T (Maximum chainring differential: 20T)  
SS: 28T (Maximum chainring differential: 13T)
- **Weight:** 275g (GX type)  
265g (GT type)  
235g (SS type)

### 2 FRONT DERAILLEUR

Model: FD-XP01-GXH  
(Code No. 29149911)  
Clamp-on/28.6mm  
(Code No. 29149913)  
Clamp-on/31.8mm  
(Code No. 29149915)  
Clamp-on/34.9mm

#### Specifications

- **Gear capacity:** 24T
- **Chaining differential:** 7~11T (Outer-center)
- **Clamp diameter:** 1-1/8" (28.6mm)  
1-1/4" (31.8mm)  
1-3/8" (34.9mm)
- **Weight:** 116g/1-1/8" (28.6mm)

### 3 SHIFT LEVER (7-SPEED)

Model: SL-XP00-R7  
(Code No. 33129571)  
Right/Index  
Model: SL-XP00-L  
(Code No. 33129701)  
Left/Power

#### Specifications

- **ACCUSHIFT PLUS Compatible**
- **Clamp diameter:** 7/8" (22.2mm)
- **Weight:** 149g/pr.

Standard	Inner Cable		Outer Casing	
	Type	Length	Type	Length
Right (Rear)	029	2,000mm	751	600×280mm
Left (Front)	029	1,500mm	751	600mm

### 4 WISHBONE SHIFTER (7-SPEED)

Model: SL-XP20-R7  
(Code No. 33829571)  
Right/Index  
Model: SL-XP20-L  
(Code No. 33829701)  
Left/Power

#### Specifications

- **ACCUSHIFT PLUS Compatible**
- **Clamp diameter:** 7/8" (22.2mm)
- **Weight:** 225g/pr.

Standard	Inner Cable		Outer Casing	
	Type	Length	Type	Length
Right (Rear)	029	2,000mm	751	520×280mm
Left (Front)	029	1,500mm	751	520mm

### 5 X-PRESS CONTROL LEVER (7-SPEED)

Model: SL-XP10-R7  
(Code No. 33159571)  
Right/Index  
Model: SL-XP10-L  
(Code No. 33159701)  
Left/Power

#### Specifications

- **ACCUSHIFT PLUS Compatible**
- **Clamp diameter:** 7/8" (22.2mm)
- **Weight:** 331g/pr.

Standard	Inner Cable		Outer Casing	
	Type	Length	Type	Length
Right (Rear)	036	2,000mm	751	520×280mm
Left (Front)	036	1,500mm	751	520mm

### 6 FRONT HUB

Model: HB-XP01-F  
(Code No. 52899111) 32H/100mm  
(Code No. 52899121) 36H/100mm  
Quick release skewer  
(Code No. 50249202)

#### Specifications

- **WTB/SUNTOUR Grease Guard System**
- **Weight:** 245g (36H/100mm)

### 7 FREEHUB<MD> (7-SPEED)

Model: FH-XP20-7  
(Code No. 47739963) 32H/130mm  
(Code No. 47739973) 36H/130mm  
(Code No. 47739965) 32H/135mm  
(Code No. 47739975) 36H/135mm  
Quick release skewer  
(Code No. 50249207) For 130mm  
(Code No. 50249208) For 135mm

#### Specifications

- **WTB/SUNTOUR Grease Guard System**
- **Weight:** 375g (36H/135mm)

### 7 FREEHUB (7-SPEED)

Model: FH-XP02-7  
(Code No. 47739913) 32H/130mm  
(Code No. 47739923) 36H/130mm  
(Code No. 47739915) 32H/135mm  
(Code No. 47739925) 36H/135mm  
Quick release skewer  
(Code No. 50249207) For 130mm  
(Code No. 50249208) For 135mm

#### Specifications

- **WTB/SUNTOUR Grease Guard System**
- **Weight:** 386g (36H/135mm)

### 8 CASSETTE COGS<MD> (7-SPEED)

Model: CS-AP20-S7  
(Code No. 47199801) 11~24T  
Silver

#### Specifications

- **PowerFlo design compatible**
- **ACCUSHIFT PLUS Compatible**
- **Standard gear ratio (Weight):**  
11×12×14×16×18×21×24T (231g)

### 8 CASSETTE COGS (7-SPEED)

Model: CS-AP10-S7  
(Code No. 47199802) 12~28T  
(Code No. 47199803) 12~30T  
Silver

#### Specifications

- **PowerFlo design compatible**
- **ACCUSHIFT PLUS Compatible**
- **Standard gear ratio (Weight):**  
12×14×16×18×21×24×28T (296g)  
12×14×16×18×21×24×30T (306g)

### 9 CHAIN

Model: CH-AP01  
(Code No. 50540116)  
Silver & Silver

#### Specifications

- **Features:** Hardening Treatment Pin
- **ACCUSHIFT PLUS Compatible**
- **Size:** 1/2"×3/32"
- **Pin width:** 7.3mm
- **Weight:** 325g (116 Links)

### 10 CRANKSET<MD>

Model: CW-XP10  
(Code No. 48119152)  
42T×32T×20T/L=170.0mm  
(Code No. 48119172)  
42T×32T×20T/L=175.0mm  
(Code No. 48119182)  
42T×32T×20T/L=177.5mm

#### Specifications

- **Features:** PowerRing (42T×32T×20T only)
- **Taper size:** VX
- **Bolt circle diameter:** 94mm (Outer & Middle)  
56mm (Inner)
- **Available chainrings:** 42T×32T×20T
- **Thread:** BC 9/16"×20T (English)
- **Weight:** 649g (42T×32T×20T/L=170.0mm)

### 11 CRANKSET

Model: CW-XP01  
(Code No. 51739747)  
46T×36T×24T/L=170.0mm  
(Code No. 51739751)  
46T×36T×24T/L=175.0mm  
(Code No. 51739755)  
46T×36T×24T/L=180.0mm

#### Specifications

- **Features:** PowerRing (46T×36T×24T)
- **Taper size:** VX
- **Bolt circle diameter:** 110mm (Outer & Middle)  
74mm (Inner)
- **Available chainrings:** 46T×36T×24T
- **Thread:** BC 9/16"×20T (English)
- **Weight:** 685g (46T×36T×24T/L=170.0mm)

### 12 BOTTOM BRACKET<MD>

Model: BB-SL10-E  
(Code No. 51109901) English  
Model: BB-SL10-73  
(Code No. 51109902) Oversize  
Model: BB-SL10-I  
(Code No. 51109904) Italian

#### Specifications

- **Features:** Microlite  
WTB/SUNTOUR Grease Guard System
- **Taper size:** VX
- **Thread:** BC 1.37"×24T (English Oversize)  
36×24T (Italian)
- **B.B.Width:** 68, 70, 73mm
- **Weight:** 275g (Model BB-SL10-E)

### 13 BOTTOM BRACKET

Model: BB-XP00-E  
(Code No. 51949901) English  
Model: BB-XP00-73  
(Code No. 51949902) Oversize  
Model: BB-XC01-I  
(Code No. 51969923) Italian

#### Specifications

- **Features:** WTB/SUNTOUR Grease Guard System  
(English, Oversize)
- **Ball size:** 1/4"×11pcs (w/bearing retainer)  
English size  
Oversize (73mm)  
1/4"×9pcs (w/bearing retainer)  
Italian size

#### ● Taper size:

- **Thread:** BC 1.37"×24T (English, Oversize)  
36×24T (Italian)

#### ● B.B.Width:

- **Weight:** 347g (Model BB-XP00-E)



### 14 BRAKE LEVER

Model: BL-XP00-S  
(Code No. 60209901)  
2-Finger type

#### Specifications

- **Reach adjustment range:**  
23mm
- **Clamp diameter:** 22.2mm
- **Weight:** 220g/pr.

### BRAKE INNER OUTER SET

(Code No. 60999901)

### 15 CANTILEVER BRAKE

Model: CT-XP20  
(Code No. 62689942)

#### Specifications

- **Shoe adjustment range:** 22.5~27.5mm
- **Weight:** 170g

### 16 CANTILEVER BRAKE (SE)

Model: CT-XP11  
(Code No. 62689932)

#### Specifications

- **Features:** Self Energizing System
- **Shoe adjustment range:** 22.5~27.5mm
- **Weight:** 231g

### 17 PEDAL

Model: PL-XP02  
(Code No. 53219931)

#### Specifications

- **Features:** WTB/SUNTOUR Grease Guard System
- **Thread:** BC 9/16"×20T (English)
- **Weight:** 305g/pr.

### 18 HEAD SET

Model: HS-XP02-J  
(Code No. 50019901) JIS  
Model: HS-XP02-I  
(Code No. 50019911) English, Italian  
Model: HS-XP02-OS  
(Code No. 50019915) Oversize

#### Specifications

- **Features:** WTB/SUNTOUR Grease Guard System
- **Type:** ATB
- **Ball size:** 5/32"×20pcs
- **Stack height:** 37mm (JIS, ITALIAN)  
34mm (OVER SIZE)
- **Weight:** 125g

Type	Thread	Race Diameter	
		Upper Cone & Lower Cup	Lower Cone
J	JIS	30.0mm	27.0mm
I	English & Italian	30.2mm	26.4mm
OS	Over Size	BC1-1/8"×26T 34.0mm	30.0mm

### 19 SEAT POST

Model: SP-XP00  
(Code No. 53669910) 26.8mm/L=300mm  
(Code No. 53669912) 27.0mm/L=300mm  
(Code No. 53669914) 27.2mm/L=300mm

#### Specifications

- **Diameter:** 25.0mm, 26.4mm, 26.6mm,  
26.8mm, 27.0mm, 27.2mm
- **Saddle angle adjustment range:**  
22~degrees
- **Saddle rail diameter:** 7~8mm
- **Weight:** 290g (26.8mm/L=300mm)

### 20 SEAT POST (OVER SIZE)

Model: SP-XP10  
(Code No. 53639921) 29.8mm/L=300mm  
(Code No. 53639931) 30.2mm/L=300mm

#### Specifications

- **Diameter:** 29.8mm, 30.2mm
- **Saddle angle adjustment range:**  
21~degrees
- **Saddle rail diameter:** 7~8mm
- **Weight:** 279g (29.8mm/L=300mm)



# SUNTOUR XC COMP **MD** & SUNTOUR XC COMP

*The expert's choice. High precision, high performance*

XC-Comp : High-quality components built around the same design ideas as XC-Pro, with the expert in mind. Light weight and durability, the cornerstones of SUNTOUR products, is built into XC-Comp designed for top performance and dependability demanded by any situation.

**MD  
POWERFLO  
WISHBONE SHIFTER  
SE  
X-PRESS  
POWERING**



THUMB SHIFTER WITH MULTIMOUNT



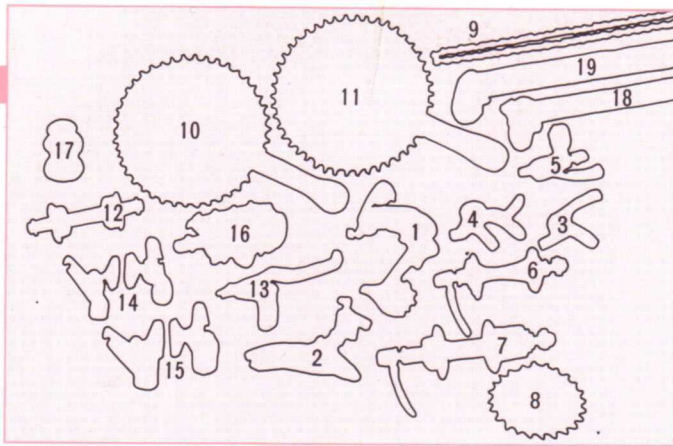

### 1 REAR DERAILLEUR

Model: RD-XC20-GXB  
(Code No. 24099921) (GX Type)  
Model: RD-XC20-GTB  
(Code No. 24089921) (GT Type)  
Model: RD-XC20-SSB  
(Code No. 24079921) (SS Type)

#### Specifications

- ACCUSHIFT PLUS Compatible
- Largest rear cog: 30T (28mm dropout) (GX, GT) 28T (28mm dropout) (SS)
- Total gear capacity: 39T (Maximum chaining differential: 22T) (GX Type) 34T (Maximum chaining differential: 20T) (GT Type) 28T (Maximum chaining differential: 13T) (SS Type)
- Weight: 268g (GX Type) 253g (GT Type) 225g (SS Type)

### 2 FRONT DERAILLEUR

Model: FD-XC01-GXH  
(Code No. 29169911)  
Clamp-on/28.6mm  
(Code No. 29169913)  
Clamp-on/31.8mm  
(Code No. 29169915)  
Clamp-on/34.9mm

#### Specifications

- Gear capacity: 24T
- Chaining differential: 7~11T (Outer~Center)
- Clamp diameter: 1-1/8" (28.6mm) 1-1/4" (31.8mm) 1-3/8" (34.9mm)
- Weight: 116g/1-1/8" (28.6mm)

### 3 SHIFT LEVER (7-SPEED)

Model: SL-XP00-R7  
(Code No. 33129571)  
Right/Index  
Model: SL-XP00-L  
(Code No. 33129701)  
Left/Power

#### Specifications

- ACCUSHIFT PLUS Compatible
- Clamp diameter: 7/8" (22.2mm)
- Weight: 149g/pr.

Standard	Inner Cable		Outer Casing	
	Type	Length	Type	Length
Right (Rear)	029	2,000mm	751	600×280mm
Left (Front)	029	1,500mm	751	600mm

### 4 WISHBONE SHIFTER (7-SPEED)

Model: SL-XP20-R7  
(Code No. 33829571)  
Right/Index  
Model: SL-XP20-L  
(Code No. 33829701)  
Left/Power

#### Specifications

- ACCUSHIFT PLUS Compatible
- Clamp diameter: 7/8" (22.2mm)
- Weight: 225g/pr.

Standard	Inner Cable		Outer Casing	
	Type	Length	Type	Length
Right (Rear)	029	2,000mm	751	520×280mm
Left (Front)	029	1,500mm	751	520mm

### 5 X-PRESS CONTROL LEVER (7-SPEED)

Model: SL-XP10-R7  
(Code No. 33159571)  
Right/Index  
Model: SL-XP10-L  
(Code No. 33159701)  
Left/Power

#### Specifications

- ACCUSHIFT PLUS Compatible
- Clamp diameter: 7/8" (22.2mm)
- Weight: 331g/pr.

Standard	Inner Cable		Outer Casing	
	Type	Length	Type	Length
Right (Rear)	036	2,000mm	751	520×280mm
Left (Front)	036	1,500mm	751	520mm

### 6 FRONT HUB

Model: HB-XC02-F  
(Code No. 52939121) 32H/100mm  
(Code No. 52939131) 36H/100mm  
Quick release skewer  
(Code No. 50249242)

#### Specifications

- Weight: 234g

### 7 FREEHUB<MD> (7-SPEED)

Model: FH-XC11-7  
(Code No. 47749963) 32H/130mm  
(Code No. 47749973) 36H/130mm  
(Code No. 47749965) 32H/135mm  
(Code No. 47749975) 36H/135mm  
Quick release skewer  
(Code No. 50249247) For 130mm  
(Code No. 50249248) For 135mm

#### Specifications

- Weight: 375g (36H/130mm)

### 7 FREEHUB (7-SPEED)

Model: FH-XC02-7  
(Code No. 47749913) 32H/130mm  
(Code No. 47749923) 36H/130mm  
(Code No. 47749915) 32H/135mm  
(Code No. 47749925) 36H/135mm  
Quick release skewer  
(Code No. 50249247) For 130mm  
(Code No. 50249248) For 135mm

#### Specifications

- Weight: 386g (36H/135mm)

### 8 CASSETTE COGS<MD> (7-SPEED)

Model: CS-AP20-S7  
(Code No. 47199801)  
Silver

#### Specifications

- PowerFlo design compatible
- ACCUSHIFT PLUS Compatible
- Standard gear ratio (Weight): 11×12×14×16×18×21×24T (231g)

### 8 CASSETTE COGS (7-SPEED)

Model: CS-AP10-S7  
(Code No. 47199802) 12~28T  
(Code No. 47199803) 12~30T  
Silver

#### Specifications

- PowerFlo design compatible
- ACCUSHIFT PLUS Compatible
- Standard gear ratio (Weight): 12×14×16×18×21×24×28T (296g) 12×14×16×18×21×24×30T (306g)

### 9 CHAIN

Model: CH-AP11  
(Code No. 50550116)  
Silver & Black

#### Specifications

- ACCUSHIFT PLUS Compatible
- Size: 1/2"×3/32"
- Pin width: 7.3mm
- Weight: 325g (116 Links)

### 10 CRANKSET<MD>

Model: CW-XC11  
(Code No. 48219152)  
42T×32T×20T/L=170.0mm  
(Code No. 48219172)  
42T×32T×20T/L=175.0mm

#### Specifications

- Features: PowerRing (42T×32T×20T only)
- Taper size: VX
- Bolt circle diameter: 94mm (Outer & Middle) 56mm (Inner)
- Available chainings: 42T×32T×20T
- Thread: BC 9/16"×20T (English)
- Weight: 685g (42T×32T×20T/170.0mm)

### 11 CRANKSET

Model: CW-XC01  
(Code No. 51589725)  
46T×36T×24T/L=170.0mm  
(Code No. 51589729)  
46T×36T×24T/L=175.0mm

#### Specifications

- Features: PowerRing (46T×36T×24T, 26T)
- Taper size: VX
- Bolt circle diameter: 110mm (Outer & Middle) 74mm (Inner)
- Available chainings: 46T×36T×24T, 46T×36T×26T
- Thread: BC 9/16"×20T (English)
- Weight: 740g (46T×36T×24T/170.0mm)

### 12 BOTTOM BRACKET<MD>

Model: BB-SL00-E  
(Code No. 51129901) English  
Model: BB-SL00-73  
(Code No. 51129902) Oversize  
Model: BB-SL00-I  
(Code No. 51129903) Italian

#### Specifications

- Ball size: 1/4"×9pcs (w/bearing retainer)
- Taper size: VX
- Thread: BC 1.37"×24T (English, Oversize) 36×24T (Italian)
- B.B. Width: 68mm, 70mm, 73mm
- Weight: 329g (Model BB-SL00-E)

### 12 BOTTOM BRACKET

Model: BB-XC01-E  
(Code No. 51969921) English  
Model: BB-XC01-73  
(Code No. 51969922) Oversize  
Model: BB-XC01-I  
(Code No. 51969923) Italian

#### Specifications

- Ball size: 1/4"×9pcs (w/bearing retainer)
- Taper size: VX
- Thread: BC 1.37"×24T (English, Oversize) 36×24T (Italian)
- B.B. Width: 68mm, 70mm, 73mm
- Weight: 348g (Model BB-XC01-E)

### 13 BRAKE LEVER

Model: BL-XC01-S  
(Code No. 60349901)  
2-Finger type

#### Specifications

- Reach adjustment range: 23mm
- Clamp diameter: 22.2mm
- Weight: 225g

### BRAKE INNER OUTER SET

(Code No. 60999901)

### 14 CANTILEVER BRAKE

Model: CT-XP20  
(Code No. 62689942)

#### Specifications

- Shoe adjustment range: 22.5~27.5mm
- Weight: 170g

### 15 CANTILEVER BRAKE (SE)

Model: CT-XP11  
(Code No. 62689932)

#### Specifications

- Features: Self Energizing System
- Shoe adjustment range: 22.5~27.5mm
- Weight: 231g

### 16 PEDAL

Model: PL-XC20  
(Code No. 53129901)

#### Specifications

- Thread: BC9/16"×20T (English)
- Weight: 315g/pr.

### 17 HEAD SET

Model: HS-ST00-J  
(Code No. 50049901) JIS  
Model: HS-ST00-I  
(Code No. 50049911) English, Italian

#### Specifications

- Type: ATB
- Ball size: 5/32"×20pcs
- Stack height: 38.1mm
- Weight: 122g

J	Type	Thread	Race Diameter	
			Upper Cone & Lower Cup	Lower Cone
	JIS		30.0mm	27.0mm
I	English & Italian	BC1"×24T	30.2mm	26.4mm

### 18 SEAT POST

Model: SP-XP00  
(Code No. 53669910) 26.8mm/L=300mm  
(Code No. 53669912) 27.0mm/L=300mm  
(Code No. 53669914) 27.2mm/L=300mm

#### Specifications

- Diameter: 25.0mm, 26.4mm, 26.6mm, 26.8mm, 27.0mm, 27.2mm
- Saddle angle adjustment range: 22-degrees
- Saddle rail diameter: 7~8mm
- Weight: 290g (26.8mm/L=300mm)

### 19 SEAT POST (Oversize)

Model: SP-XP10  
(Code No. 53639921) 29.8mm/L=300mm  
(Code No. 53639931) 30.2mm/L=300mm

#### Specifications

- Diameter: 29.8mm, 30.2mm
- Saddle angle adjustment range: 21-degrees
- Saddle rail diameter: 7~8mm
- Weight: 279g (29.8mm/L=300mm)





# SUNTOUR XC LTD

Where technology and value meet

From racing to touring, these high-performance components are designed to serve a wide range of rider needs. XC-LTD, sharing many of the same characteristics as XC-Pro and XC-COMP, stands out as SUNTOUR's best value component group.

**POWERFLO  
WISHBONE SHIFTER  
X-PRESS  
POWERING**

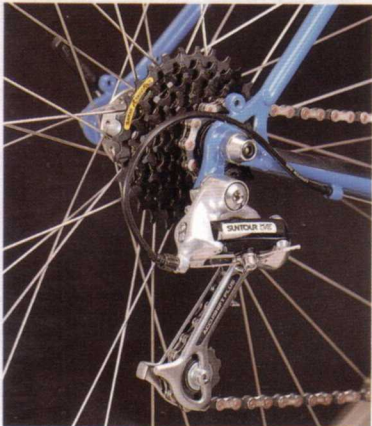



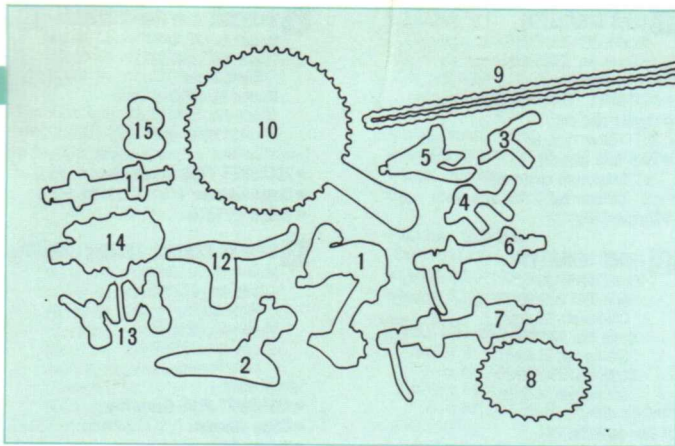

### 1 REAR DERAILLEUR (GX Type)

Model: RD-XL00-GXB  
(Code No. 24139921)

#### Specifications

##### ● ACCUSHIFT PLUS Compatible

- **Largest rear cog:** 30T (28mm dropout)
- **Total gear capacity:** 39T (Maximum chainring differential: 22T)
- **Weight:** 310g

### 2 FRONT DERAILLEUR

Model: FD-XL00-GXH  
(Code No. 29849911)  
Clamp-on/28.6mm  
(Code No. 29849913)  
Clamp-on/31.8mm  
(Code No. 29849915)  
Clamp-on/34.9mm

#### Specifications

- **Gear capacity:** 24T
- **Chaining differential:** 7~11T (Outer~Center)
- **Clamp diameter:** 1-1/8" (28.6mm)  
1-1/4" (31.8mm)  
1-3/8" (34.9mm)
- **Weight:** 116g/1-1/8" (28.6mm)

### 3 SHIFT LEVER (7-SPEED)

Model: SL-XL00-R7  
(Code No. 33279571)  
Right/Index  
Model: SL-XL00-L  
(Code No. 33279701)  
Left/Power

#### Specifications

- **ACCUSHIFT PLUS Compatible**
- **Clamp diameter:** 7/8" (22.2mm)
- **Weight:** 143g/pr.

Standard	Inner Cable		Outer Casing	
	Type	Length	Type	Length
Right (Rear)	029	2,000mm	751	600×280mm
Left (Front)	029	1,500mm	751	600mm

### 4 WISHBONE SHIFTER (7-SPEED)

Model: SL-XP20-R7  
(Code No. 33829571)  
Right/Index  
Model: SL-XP20-L  
(Code No. 33829701)  
Left/Power

#### Specifications

- **ACCUSHIFT PLUS Compatible**
- **Clamp diameter:** 7/8" (22.2mm)
- **Weight:** 225g/pr.

Standard	Inner Cable		Outer Casing	
	Type	Length	Type	Length
Right (Rear)	029	2,000mm	751	520×280mm
Left (Front)	029	1,500mm	751	520mm

### 5 X-PRESS CONTROL LEVER (7-SPEED)

Model: SL-XL10-R7  
(Code No. 33289571)  
Right/Index  
Model: SL-XL10-L  
(Code No. 33289701)  
Left/Power

#### Specifications

- **ACCUSHIFT PLUS Compatible**
- **Clamp diameter:** 7/8" (22.2mm)
- **Weight:** 341g/pr.

Standard	Inner Cable		Outer Casing	
	Type	Length	Type	Length
Right (Rear)	036	2,000mm	751	520×280mm
Left (Front)	036	1,500mm	751	520mm

### 6 FRONT HUB

Model: HB-XL00-F  
(Code No. 52979121) 32H/100mm  
(Code No. 52979131) 36H/100mm  
Quick release skewer  
(Code No. 50249252)

#### Specifications

- **Weight:** 235g

### 7 FREEHUB (7-SPEED)

Model: FH-XL01-7  
(Code No. 47759923) 32H/130mm  
(Code No. 47759932) 36H/130mm  
(Code No. 47759925) 32H/135mm  
(Code No. 47759935) 36H/135mm  
Quick release skewer  
(Code No. 50249257) For 130mm  
(Code No. 50249258) For 135mm

#### Specifications

- **Weight:** 386g (36H/135mm)

### 8 CASSETTE COGS (7-SPEED)

Model: CS-AP10-K7  
(Code No. 47199702) 12~28T  
(Code No. 47199703) 12~30T  
Black

#### Specifications

- **ACCUSHIFT PLUS Compatible**
- **PowerFlo design compatible**
- **Standard gear ratio (Weight):**  
12×14×16×18×21×24×28T (296g)  
12×14×16×18×21×24×30T (306g)

### 9 CHAIN

Model: CH-AP11  
(Code No. 50550116)  
Silver & Black

#### Specifications

- **ACCUSHIFT PLUS Compatible**
- **Size:** 1/2"×3/32"
- **Pin width:** 7.3mm
- **Weight:** 325g (116 Links)

### 10 CRANKSET

Model: CW-XL00  
(Code No. 51759747)  
46T×36T×24T/L=170.0mm  
(Code No. 51759751)  
46T×36T×24T/L=175.0mm

#### Specifications

- **Features:** PoweRing (46T×36T×24T, 26T)
- **Taper size:** VX
- **Bolt circle diameter:** 110mm (Outer & Middle)  
74mm (Inner)
- **Available chainrings:**  
46T×36T×24T, 46T×36T×26T
- **Thread:** BC 9/16"×20T (English)
- **Weight:** 720g (46T×36T×24T/170.0mm)

### 11 BOTTOM BRACKET

Model: BB-XC01-E  
(Code No. 51969921) English  
Model: BB-XC01-73  
(Code No. 51969922) Oversize  
Model: BB-XC01-I  
(Code No. 51969923) Italian

#### Specifications

- **Ball size:** 1/4"×9pcs (w/bearing retainer)
- **Taper size:** VX
- **Thread:** BC 1.37"×24T (English, Oversize)  
36×24T (Italian)
- **B.B. Width:** 68mm, 70mm, 73mm
- **Weight:** 348g (Model BB-XC01-E)

### 12 BRAKE LEVER

Model: BL-XL00-S  
(Code No. 60359901)  
2-Finger type

#### Specifications

- **Reach adjustment range:** 23mm
- **Clamp diameter:** 22.2mm
- **Weight:** 262g/pr.

### 13 BRAKE INNER OUTER SET

(Code No. 60999926)

### 13 CANTILEVER BRAKE

Model: CT-XL00  
(Code No. 62729941)

#### Specifications

- **Shoe adjustment range:** 22.5~27.5mm
- **Weight:** 170g

### 14 PEDAL

Model: PL-XL00  
(Code No. 53159901)

#### Specifications

- **Thread:** BC 9/16"×20T (English)
- **Weight:** 395g/pr.

### 15 HEAD SET

Model: HS-ST00-J  
(Code No. 50049901) JIS  
Model: HS-ST00-I  
(Code No. 50049911) English, Italian

#### Specifications

- **Type:** ATB
- **Ball size:** 5/32"×20pcs
- **Stack height:** 38.1mm
- **Weight:** 122g

J	Type	Thread	Race Diameter	
			Upper Cone & Lower Cup	Lower Cone
1	JIS	BC1"×24T	30.0mm	27.0mm
1	English & Italian		30.2mm	26.4mm





# SUNTOUR X-1

Expert performance for sport touring riders



**POWERFLO  
WISHBONE SHIFTER**

**X-PRESS  
POWERING**

## 1 REAR DERAILLEUR

Model: RD-X101-GXB  
(Code No. 24239921)

Specifications

● **ACCUSHIFT PLUS Compatible**

● **Largest rear cog:**  
30T (28mm dropout)

● **Total gear capacity:**  
39T (Maximum chainring  
differential: 22T)

● **Weight:** 310g

## 2 FRONT DERAILLEUR

Model: FD-X100-GXH  
(Code No. 29019811)  
Clamp-on/28.6mm  
(Code No. 29019815)  
Clamp-on/31.8mm  
(Code No. 29019813)  
Clamp-on/34.9mm

Specifications

● **Gear capacity:** 24T

● **Chainring differential:** 7~11T (Outer~Center)

● **Clamp diameter:** 1-1/8" (28.6mm)  
1-1/4" (31.8mm)  
1-3/8" (34.9mm)

● **Weight:** 109g/1-1/8" (28.6mm)

## 3 SHIFT LEVER (7-SPEED)

Model: SL-X102-R7  
(Code No. 33429571)

Right/Index

Model: SL-X102-L  
(Code No. 33429701)

Left/Power

Specifications

● **ACCUSHIFT PLUS Compatible**

● **Clamp diameter:** 7/8" (22.2mm)

● **Weight:** 151g/pr.

## 4 WISHBONE SHIFTER (7-SPEED)

Model: SL-XP20-R7  
(Code No. 33829571)

Right/Index

Model: SL-XP20-L  
(Code No. 33829701)

Left/Power

Specifications

● **ACCUSHIFT PLUS Compatible**

● **Clamp diameter:** 7/8" (22.2mm)

● **Weight:** 225g/pr.

## 5 X-PRESS CONTROL LEVER (7-SPEED)

Model: SL-XL10-R7  
(Code No. 33289571)

Right/Index

Model: SL-XL10-L  
(Code No. 33289701)

Left/Power

Specifications

● **ACCUSHIFT PLUS Compatible**

● **Clamp diameter:** 7/8" (22.2mm)

● **Weight:** 341g/pr.

## 6 FRONT HUB

Model: HB-AT02-F

(Code No. 52979122) 32H/100mm  
(Code No. 52979132) 36H/100mm

Quick release skewer

(Code No. 50249252)

Specifications

● **Weight:** 235g

## 7 FREEHUB (7-SPEED)

Model: FH-AT01-7

(Code No. 47759963) 32H/130mm  
(Code No. 47759973) 36H/130mm  
(Code No. 47759965) 32H/135mm  
(Code No. 47759975) 36H/135mm

Quick release skewer

(Code No. 50249257) For 130mm  
(Code No. 50249258) For 135mm

Specifications

● **Weight:** 398g (36H/135mm)

# SUNTOUR FS-E



**POWERFLO  
WISHBONE SHIFTER  
LITE OPERATION**

**X-PRESS  
POWERING**

## 1 REAR DERAILLEUR

Model: RD-FE00-GXB  
(Code No. 24259921)

Specifications

● **ACCUSHIFT PLUS Compatible**

● **Largest rear cog:**  
30T (28mm dropout)

● **Total gear capacity:**  
39T (Maximum chainring  
differential: 22T)

● **Weight:** 280g

## 2 FRONT DERAILLEUR

Model: FD-FE00-GXH  
(Code No. 29189911)  
Clamp-on/28.6mm  
(Code No. 29189913)  
Clamp-on/31.8mm  
(Code No. 29189915)  
Clamp-on/34.9mm

Specifications

● **Gear capacity:** 24T

● **Chainring differential:** 7~11T (Outer~Center)

● **Clamp diameter:** 1-1/8" (28.6mm)  
1-1/4" (31.8mm)  
1-3/8" (34.9mm)

● **Weight:** 115g/1-1/8" (28.6mm)

## 3 SHIFT LEVER (7-SPEED)

Model: SL-XM01-R7  
(Code No. 33639571)

Right/Index

Model: SL-XM01-L  
(Code No. 33639701)

Left/Power

Specifications

● **ACCUSHIFT PLUS Compatible**

● **Clamp diameter:** 7/8" (22.2mm)

● **Weight:** 152g/pr.

## 4 WISHBONE SHIFTER (7-SPEED)

Model: SL-FE20-R7  
(Code No. 33839571)

Right/Index

Model: SL-FE20-L  
(Code No. 33839701)

Left/Power

Specifications

● **ACCUSHIFT PLUS Compatible**

● **Clamp diameter:** 7/8" (22.2mm)

● **Weight:** 225g/pr.

## 5 X-PRESS CONTROL LEVER (7-SPEED)

Model: SL-XM10-R7  
(Code No. 33619571)

Right/Index

Model: SL-XM10-L  
(Code No. 33619701)

Left/Power

Specifications

● **ACCUSHIFT PLUS Compatible**

● **Clamp diameter:** 7/8" (22.2mm)

● **Weight:** 335g/pr.

## 6 COMMAND SHIFTER

Model: SL-CD01-R7  
(Code No. 32219911)

Right/Index

Model: SL-CD01-L  
(Code No. 32219921)

Left/Power

Specifications

● **ACCUSHIFT PLUS Compatible**

● **Mounting position:** Handlebar

● **Weight:** 185g

## 7 FRONT HUB

Model: HB-AT02-F

(Code No. 52979122) 32H/100mm  
(Code No. 52979132) 36H/100mm

Quick release skewer

(Code No. 50249252)

Specifications

● **Weight:** 235g

## 8 FREEHUB (7-SPEED)

Model: FH-AT01-7

(Code No. 47759963) 32H/130mm  
(Code No. 47759973) 36H/130mm  
(Code No. 47759965) 32H/135mm  
(Code No. 47759975) 36H/135mm

Quick release skewer

(Code No. 50249257) For 130mm  
(Code No. 50249258) For 135mm

Specifications

● **Weight:** 398g (36H/135mm)



- 8 CASSETTE COGS (7-SPEED)**  
 Model: CS-AP10-K7  
 (Code No. 47199702) (12T~28T)  
 (Code No. 47199703) (12T~30T)  
 Black

Specifications

- ACCUSHIFT PLUS Compatible
- PowerFlo design compatible
- Standard gear ratio (Weight):  
 12×14×16×18×21×24×28T (296g)  
 12×14×16×18×21×24×30T (306g)

**9 REAR HUB**

- Model: HB-AT02-R  
 (Code No. 52979224) 32H/130mm  
 (Code No. 52979234) 36H/130mm  
 (Code No. 52979226) 32H/135mm  
 (Code No. 52979236) 36H/135mm  
 Quick release skewer  
 (Code No. 50249257) For 130mm  
 (Code No. 50249258) For 135mm

Specifications

- Thread: BC 1.37"×24T (English)
- "D" dimension: 37mm
- Weight: 326g (36H/135mm)

**10 FREEWHEEL (7-SPEED)**

- Model: FW-AL10-K7  
 (Code No. 15079703)  
 Black

Specifications

- ACCUSHIFT PLUS Compatible
- Thread: BC 1.37"×24T (English)
- Compatible "D" dimension: 37mm
- Standard gear ratio (Weight):  
 13×15×17×19×21×24×28T (483g)  
 13×15×17×20×23×26×30T (514g)

**11 CAHIN**

- Model: CH-AP15  
 (Code No. 50560116)  
 Black & Black

Specifications

- ACCUSHIFT PLUS Compatible
- Size: 1/2"×3/32"
- Pin width: 7.3mm
- Weight: 325g (116 Links)

**9 CASSETTE COGS (7-SPEED)**

- Model: CS-AP10-K7  
 (Code No. 47199702) 12T~28T  
 (Code No. 47199703) 12T~30T  
 Black

Specifications

- ACCUSHIFT PLUS Compatible
- PowerFlo design compatible
- Standard gear ratio (Weight):  
 12×14×16×18×21×24×28T (296g)  
 12×14×16×18×21×24×30T (306g)

**10 CHAIN**

- Model: CH-AP15  
 (Code No. 50560116)  
 Black & Black

Specifications

- ACCUSHIFT PLUS Compatible
- Size: 1/2"×3/32"
- Pin width: 7.3mm
- Weight: 325g (116 Links)

**11 CRANK SET**

- Model: CW-FS00-S  
 (Code No. 48719158)  
 50T×40T×28T/L=170.0mm  
 (Code No. 48719178)  
 50T×40T×28T/L=175.0mm

Specifications

- Features: PowerRing
- Taper size: VX
- Bolt circle diameter: 110mm (Outer & Middle)  
 74mm (Inner)
- Available chainrings: 50T×40T×28T
- Thread: BC 9/16"×20T (English)
- Weight: 960g (50T×40T×28T/170.0mm)

**11 CRANK SET**

- Model: CW-FS00-N  
 (Code No. 48719132)  
 52T×42T×32T/L=165.0mm  
 (Code No. 48719152)  
 52T×42T×32T/L=170.0mm  
 (Code No. 48719172)  
 52T×42T×32T/L=175.0mm

**12 CRANK SET**

- Model: CW-X101  
 (Code No. 51409812)  
 46T×36T×24T/L=170.0mm  
 (Code No. 51409822)  
 46T×36T×24T/L=175.0mm

Specifications

- Features: PowerRing (46×36×24T, 48×38×28T)
- Taper size: VX
- Bolt circle diameter: 110mm (Outer & Middle)  
 74mm (Inner)
- Available chainrings:  
 46T×36T×24T, 48T×38T×28T
- Thread: BC 9/16"×20T (English)
- Weight: 730g (48T×38T×28T/170.0mm)

**13 BOTTOM BRACKET**

- Model: BB-X101-E  
 (Code No. 51049921) English  
 Model: BB-X101-I  
 (Code No. 51049923) Italian

Specifications

- Ball size: 1/4"×9pcs (w/bearing retainer)
- Taper size: VX
- Thread: BC 1.37"×24T (English)  
 36×24T (Italian)
- B.B. Width: 68, 70mm
- Weight: 361g

**14 BRAKE LEVER <Dia-compe>**

- Model: BL-X101-S  
 (Code No. 60369901)  
 2-Finger type

Specifications

- Reach adjustment range:  
 23mm
- Clamp diameter: 22.2mm
- Weight: 266g/pr.

**15 CANTILEVER BRAKE <Dia-compe>**

- Model: CT-X101  
 (Code No. 62249921)

Specifications

- Shoe adjustment range: 20~30mm
- Weight: 168g/pr.

Specifications

- Features: PowerRing
- Taper size: VX
- Bolt circle diameter: 130mm (Outer & Middle)  
 74mm (Inner)
- Available chainrings: 52T×42T×32T
- Thread: BC 9/16"×20T (English)
- Weight: 760g (52T×42T×32T/170.0mm)

**12 BOTTOM BRACKET**

- Model: BB-X101-E  
 (Code No. 51049921) English  
 Model: BB-X101-I  
 (Code No. 51049923) Italian

**13 BRAKE LEVER <Dia-compe>**

- Model: BL-FE00-N  
 (Code No. 60439901)

**14 BRAKE LEVER <Dia-compe>**

- Model: BL-FE10-N  
 (Code No. 60439921)

**15 CANTILEVER BRAKE <Dia-compe>**

- Model: CT-FE00  
 (Code No. 62819901)

**16 BRAKE CALIPER <Dia-compe>**

- Model: BA-FE00  
 F (Code No. 62429901)  
 Front/Recessed  
 R (Code No. 62429903)  
 Rear/Recessed



SUNTOUR XCE



POWERFLO  
WISHBONE SHIFTER

X-PRESS  
POWERING

**1 REAR DERAILLEUR**

- Model: RD-XE01-GXB  
 (Code No. 24289921)

**2 FRONT DERAILLEUR**

- Model: FD-XE01-GXH  
 (Code No. 29869911)  
 Clamp-on/28.6mm  
 (Code No. 29869913)  
 Clamp-on/31.8mm  
 (Code No. 29869915)  
 Clamp-on/34.9mm

**3 SHIFT LEVER (7-SPEED)**

- Model: SL-X102-R7  
 (Code No. 33429571)  
 Right/Index  
 Model: SL-X102-L  
 (Code No. 33429701)  
 Left/Power

**4 WISHBONE SHIFTER (7-SPEED)**

- Model: SL-XP20-R7  
 (Code No. 33829571)  
 Right/Index  
 Model: SL-XP20-L  
 (Code No. 33829701)  
 Left/Power

**5 X-PRESS CONTROL LEVER (7-SPEED)**

- Model: SL-XL10-R7  
 (Code No. 33289571)  
 Right/Index  
 Model: SL-XL10-L  
 (Code No. 33289701)  
 Left/Power

**6 FRONT HUB**

- Model: HB-AT02-F  
 (Code No. 52979122) 32H/100mm  
 (Code No. 52979132) 36H/100mm  
 Quick release skewer  
 (Code No. 50249252)

**7 FREEHUB (7-SPEED)**

- Model: FH-AT01-7  
 (Code No. 47759963) 32H/130mm  
 (Code No. 47759973) 36H/130mm  
 (Code No. 47759965) 32H/135mm  
 (Code No. 47759975) 36H/135mm  
 Quick release skewer  
 (Code No. 50249257) For 130mm  
 (Code No. 50249258) For 135mm

**8 CASSETTE COGS (7-SPEED)**

- Model: CS-AP10-K7  
 (Code No. 47199702) (12~28T)  
 (Code No. 47199703) (12~30T)  
 Black

**9 REAR HUB**

- Model: HB-AT02-R  
 (Code No. 52979224) 32H/130mm  
 (Code No. 52979234) 36H/130mm  
 (Code No. 52979226) 32H/135mm  
 (Code No. 52979236) 36H/135mm  
 Quick release skewer  
 (Code No. 50249257) For 130mm  
 (Code No. 50249258) For 135mm

**10 FREEWHEEL (7-SPEED)**

- Model: FW-AL10-K7  
 (Code No. 15079703)

**11 CHAIN**

- Model: CH-AP21  
 (Code No. 50710116)

**12 CRANKSET**

- Model: CW-XE01  
 (Code No. 51689755)  
 48T×38T×28T/L=170.0mm  
 (Code No. 51689759)  
 48T×38T×28T/L=175.0mm

**13 BOTTOM BRACKET**

- Model: BB-X101-E  
 (Code No. 51049921) English  
 Model: BB-X101-I  
 (Code No. 51049923) Italian

**14 CANTILEVER BRAKE <Dia-compe>**

- Model: CT-XE01  
 (Code No. 62769921)

**15 BRAKE LEVER <Dia-compe>**

- Model: BL-XE01-S  
 (Code No. 60379901)  
 2-Finger type  
 Model: BL-XE01-N  
 (Code No. 60379911)  
 4-Finger type



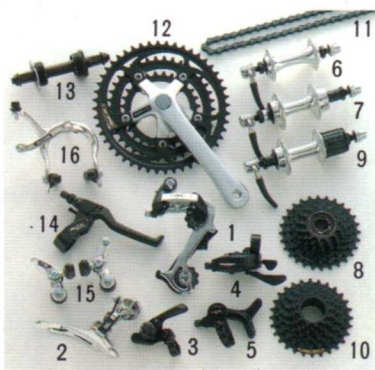

**POWERFLO  
WISHBONE SHIFTER  
LITE OPERATION  
X-PRESS  
POWERING**

**1 REAR DERAILLEUR**  
Model: RD-XM02-GXB  
(Code No. 24309921)

**2 FRONT DERAILLEUR**  
Model: FD-XM02-GXH  
(Code No. 29199911)  
Clamp-on/28.6mm  
(Code No. 29199913)  
Clamp-on/31.8mm  
(Code No. 29199915)  
Clamp-on/34.9mm

**3 SHIFT LEVER (7-SPEED)**  
Model: SL-XM01-R7  
(Code No. 33639571)  
Right/Index  
Model: SL-XM01-L  
(Code No. 33639701)  
Left/Power

**4 X-PRESS CONTROL LEVER (7-SPEED)**  
Model: SL-XM10-R7  
(Code No. 33619571)  
Right/Index  
Model: SL-XM10-L  
(Code No. 33619701)  
Left/Power

**5 WISHBONE SHIFTER (7-SPEED)**  
Model: SL-XM20-R7  
(Code No. 33849571)  
Right/Index  
Model: SL-XM20-L  
(Code No. 33849701)  
Left/Power

**6 FRONT HUB**  
Model: HB-AT02-F  
(Code No. 52979122) 32H/100mm  
(Code No. 52979132) 36H/100mm  
Quick release skewer  
(Code No. 50249252)

**7 REAR HUB**  
Model: HB-AT02-R  
(Code No. 52979224) 32H/130mm  
(Code No. 52979234) 36H/130mm  
(Code No. 52979226) 32H/135mm  
(Code No. 52979236) 36H/135mm  
Quick release skewer  
(Code No. 50249257) For 130mm  
(Code No. 50249258) For 135mm

**8 FREEWHEEL (7-SPEED)**  
Model: FW-AL10-K7  
(Code No. 15079703)

**9 FREEHUB (7-SPEED)**  
Model: FH-AT01-7  
(Code No. 47759963) 32H/130mm  
(Code No. 47759973) 36H/130mm  
(Code No. 47759965) 32H/135mm  
(Code No. 47759975) 36H/135mm  
Quick release skewer  
(Code No. 50249257) For 130mm  
(Code No. 50249258) For 135mm

**10 CASSETTE COGS (7-SPEED)**  
Model: CS-AP10-K7  
(Code No. 47199702) (12~28T)  
(Code No. 47199703) (12~30T)

**11 CHAIN**  
Model: CH-AP21  
(Code No. 50710116)

**12 CRANKSET**  
Model: CW-XM01  
(Code No. 51709755)  
48T×38T×28T/L=170.0mm  
(Code No. 51709759)  
48T×38T×28T/L=175.0mm  
\*50T×40T×28T Available

**13 BOTTOM BRACKET**  
Model: BB-X101-E  
(Code No. 51049921) Engl  
Model: BB-X101-I  
(Code No. 51049923) Itali

**14 BRAKE LEVER**  
<Dia-compe>  
Model: BL-XM01-N  
(Code No. 60389901)  
4-Finger type

**15 CANTILEVER BRAKE**  
Model: CT-XM01  
(Code No. 62779921)

**16 CALIPER BRAKE**  
<Dia-compe>  
Model: BA-XM00  
F (Code No. 62439901)  
R (Code No. 62439903)



**WISHBONE SHIFTER  
LITE OPERATION  
X-PRESS  
POWERING**

**1 REAR DERAILLEUR**  
Model: RD-XT02-GXB  
(Code No. 24359921)  
W0/Bracket  
Model: RD-XT02-GXZ  
(Code No. 24359901)  
W/Bracket

**2 FRONT DERAILLEUR**  
Model: FD-XT02-GXH  
(Code No. 29219911)  
Clamp-on/28.6mm  
(Code No. 29219913)  
Clamp-on/31.8mm

**3 SHIFT LEVER (7-SPEED)**  
Model: SL-XM01-R7  
(Code No. 33639571)  
Right/Index  
Model: SL-XM01-L  
(Code No. 33639701)  
Left/Power

**4 WISHBONE SHIFTER (7-SPEED)**  
Model: SL-XM20-R7  
(Code No. 33849571)  
Right/Index  
Model: SL-XM20-L  
(Code No. 33849701)  
Left/Power

**5 X-PRESS CONTROL LEVER (7-SPEED)**  
Model: SL-XM10-R7  
(Code No. 33619571)  
Right/Index  
Model: SL-XM10-L  
(Code No. 33619701)  
Left/Power

**6 FRONT HUB**  
Model: HB-AT02-F  
(Code No. 52979122) 32H/100mm  
(Code No. 52979132) 36H/100mm  
Quick release skewer  
(Code No. 50249252)

**7 REAR HUB**  
Model: HB-AT02-R  
(Code No. 52979224) 32H/130mm  
(Code No. 52979234) 36H/130mm  
(Code No. 52979226) 32H/135mm  
(Code No. 52979236) 36H/135mm  
Quick release skewer  
(Code No. 50249257) For 130mm  
(Code No. 50249258) For 135mm

**8 FREEWHEEL (7-SPEED)**  
Model: FW-AL10-K7  
(Code No. 15079703)

**9 CHAIN**  
Model: CH-AP20  
(Code No. 50690116)

**10 CRANKSET <SR>**  
Model: CW-XT01  
(Code No. 51569821)  
48T×38T×28T/L=165.0mm  
(Code No. 51569825)  
48T×38T×28T/L=170.0mm  
(Code No. 51569829)  
48T×38T×28T/L=175.0mm

**10 CRANKSET <SR>**  
Model: CW-XT02  
(Code No. 51489958)  
48T×38T×28T/L=170.0mm  
(Code No. 51489978)  
48T×38T×28T/L=175.0mm  
\*50T×40T×28T Available

**11 BOTTOM BRACKET <SR>**  
Model: BB-XT00-E  
(Code No. 51079921) English

**12 CANTILEVER BRAKE <Dia-compe>**  
Model: CT-XU01  
(Code No. 62789921)

**13 CALIPER BRAKE**  
<Dia-compe>  
Model: BA-XM00  
F (Code No. 62439901)  
R (Code No. 62439903)

**14 BRAKE LEVER**  
<Dia-compe>  
Model: BL-XT01-N  
(Code No. 60399901)  
4-Finger type



**WISHBONE SHIFTER  
LITE OPERATION  
X-PRESS  
POWERING**

**1 REAR DERAILLEUR**  
Model: RD-XU01-GXB  
(Code No. 82259911)  
W0/Bracket  
Model: RD-XU01-GXZ  
(Code No. 82259901)  
W/Bracket

**2 FRONT DERAILLEUR**  
Model: FD-XU00-GXH  
(Code No. 82889911)  
Clamp-on/28.6mm

**3 SHIFT LEVER (7-SPEED)**  
Model: SL-XU01-R7  
(Code No. 83139011)  
Right/Index  
Model: SL-XU01-L  
(Code No. 83139021)  
Left

**4 X-PRESS CONTROL LEVER (7-SPEED)**  
Model: SL-XM10-R7  
(Code No. 33619571)  
Right/Index  
Model: SL-XM10-L  
(Code No. 33619701)  
Left/Power

**5 WISHBONE SHIFTER (7-SPEED)**  
Model: SL-XU20-R7  
(Code No. 83219011)  
Right/Index  
Model: SL-XU20-L  
(Code No. 83219021)  
Left/Power

**6 FREEWHEEL (7-SPEED)**  
Model: FW-AL10-K7  
(Code No. 15079703)

**7 CHAIN**  
Model: CH-AP20  
(Code No. 50690116)

**8 CRANKSET <SR>**  
Model: CW-XU00  
(Code No. 51419921)  
48T×38T×28T/L=165.0mm  
(Code No. 51419929)  
48T×38T×28T/L=170.0mm  
(Code No. 51419937)  
48T×38T×28T/L=175.0mm

**9 BOTTOM BRACKET <SR>**  
Model: BB-XT00-E  
(Code No. 51079921) English

**10 CANTILEVER BRAKE <Dia-compe>**  
Model: CT-XU00  
(Code No. 62799901)

**11 BRAKE LEVER <Dia-compe>**  
Model: BL-XU00-N  
(Code No. 60409901)  
4-Finger type



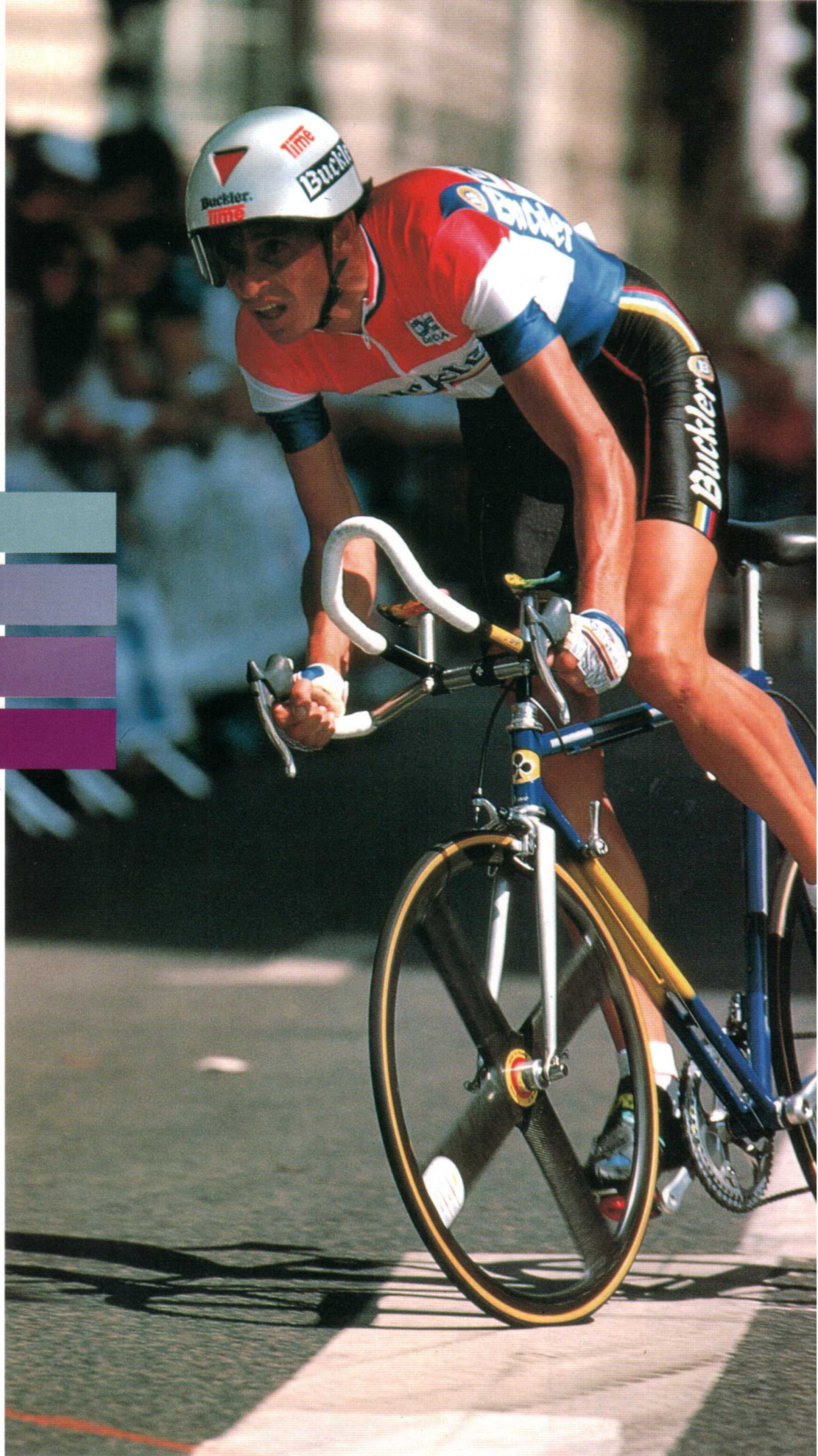

## ROAD

### < COMPONENTS >

SUPERBE PRO  
SL  
RADIUS  
EDGE  
BLAZE  
VX  
RT

Photo/'91 TOUR DE FRANCE.



# SUNTOUR SUPERBE PRO

Representing SUNTOUR's commitment to perfection

The finest materials and precision manufacturing processes, combined with state-of-the-art component technology has enabled SUNTOUR to produce Superbe Pro with professional road racers in mind. From cartridge bearings to cold forgings, Superbe Pro is recognized by professional riders and mechanics the world over for its excellence.

## CARTRIDGE BEARING



CASSETTE COGS(8Speed)



### 1 REAR DERAILLEUR

Model: RD-SB00-SSB  
(Code No. 25009921)

#### Specifications

- ACCUSHIFT PLUS Compatible
- Largest rear cog: 26T (24mm dropout)
- Total gear capacity: 26T (Maximum chainring differential: 13T)
- Weight: 194g

### 2 FRONT DERAILLEUR

Model: FD-SB00-SSH  
(Code No. 29269901)  
Clamp-on/28.6mm  
(Code No. 29269913)  
Clamp-on/31.8mm  
Model: FD-SB00-SSB  
(Code No. 29269921)  
Braze-on

#### Specifications

- Gear capacity: 16T
- Clamp diameter: 1-1/8" (28.6mm)  
1-1/4" (31.8mm)
- Weight: 92g (Braze-on)



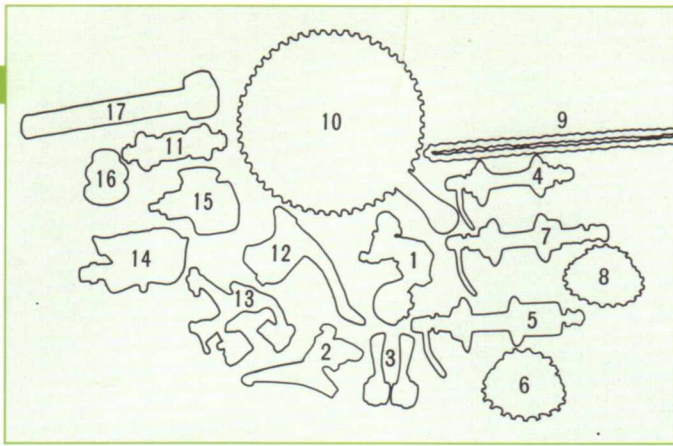

### 3 SHIFT LEVER (8 & 7-SPEED)

Model: SL-SB02-B  
(Code No. 32239851)  
Braze-on  
Model: SL-SB02-BF  
(Code No. 32239852)  
Braze-on/Aluminum frame

#### Specifications

- ACCUSHIFT PLUS Compatible
- Clamp diameter: 1-1/8" (28.6mm)
- Weight: 89g (Braze-on)

Standard	Inner Cable		Outer Casing	
	Type	Length	Type	Length
Right (Rear)	029	1,300mm	543	280mm
Left (Front)	029	800mm	543	—

### 4 FRONT HUB

Model: HB-SB00-F  
(Code No. 52359201) 28H/100mm  
(Code No. 52359205) 32H/100mm  
(Code No. 52359209) 36H/100mm  
Quick release skewer  
(Code No. 50229125)

#### Specifications

- Weight: 240g (36H/100mm)

### 5 FREEHUB (8-SPEED)

Model: FH-SB00-8  
(Code No. 47559963) 28H/130mm  
(Code No. 47559973) 32H/130mm  
(Code No. 47559983) 36H/130mm  
Quick release skewer  
(Code No. 50229130) For 130mm

#### Specifications

- Weight: 476g (36H/130mm)

### 5 FREEHUB (7-SPEED)

Model: FH-SB00-7  
(Code No. 47559931) 28H/126mm  
(Code No. 47559941) 32H/126mm  
(Code No. 47559951) 36H/126mm  
(Code No. 47559933) 28H/130mm  
(Code No. 47559943) 32H/130mm  
(Code No. 47559953) 36H/130mm  
Quick release skewer  
(Code No. 50229128) For 126mm  
(Code No. 50229130) For 130mm

#### Specifications

- Weight: 458g (36H/126mm)

### 6 CASSETTE COGS (8-SPEED)

Model: CS-AP00-S8  
(Code No. 47189803) (12~23T)  
(Code No. 47189813) (13T~24T)  
Silver

#### Specifications

- ACCUSHIFT PLUS Compatible
- Standard gear ratio (Weight):  
12×13×14×15×17×19×21×23T (265g)  
13×14×15×16×18×20×22×24T (296g)

### 6 CASSETTE COGS (7-SPEED)

Model: CS-AP00-S7  
(Code No. 47179802) Top/12T  
(Code No. 47179803) Top/13T  
Silver

#### Specifications

- ACCUSHIFT PLUS Compatible
- Standard gear ratio (Weight):  
13×14×15×17×19×21×24T (257g)  
12×13×14×15×17×19×21T (220g)

### 7 REAR HUB

Model: HB-SB00-R  
(Code No. 52359235) 28H/126mm  
(Code No. 52359243) 32H/126mm  
(Code No. 52359251) 36H/126mm  
(Code No. 52359260) 28H/130mm  
(Code No. 52359261) 32H/130mm  
(Code No. 52359257) 36H/130mm  
Quick release skewer  
(Code No. 50229128) For 126mm  
(Code No. 50229130) For 130mm

#### Specifications

- Thread: BC 1.37"×24T
- "D" dimension: 37mm (126mm, 130mm)
- Weight: 297g (36H/126mm)

### 8 FREEWHEEL (7-SPEED)

Model: FW-WT10-S7  
(Code No. 17079802) Top/12T  
(Code No. 17079803) Top/13T

#### Specifications

- ACCUSHIFT PLUS Compatible
- Thread: BC 1.37"×24T
- Compatible "D" dimension: 37mm
- Standard gear ratio (Weight):  
13×14×15×17×19×21×24T (422g)

### 9 CHAIN

Model: CH-AP01  
(Code No. 50540116)

#### Specifications

- ACCUSHIFT PLUS Compatible
- Hardening Treatment Pin
- Size: 1/2"×3/32"
- Pin width: 7.3mm
- Weight: 325g (116 Links)

### 10 CRANKSET

Model: CW-SB10  
(Code No. 51449901)  
52T×42T/L=165.0mm  
(Code No. 51449905)  
52T×42T/L=167.5mm  
(Code No. 51449909)  
52T×42T/L=170.0mm  
(Code No. 51449913)  
52T×42T/L=172.5mm  
(Code No. 51449917)  
52T×42T/L=175.0mm

#### Specifications

- Taper size: SUPERBE
- Bolt circle diameter: 130mm
- Available chainrings: 38~43T, 48~53T
- Thread: BC 9/16"×20T
- Weight: 680g (52T×42T/170.0mm)

### 11 BOTTOM BRACKET

Model: BB-SB11-E  
(Code No. 51799961) English  
Model: BB-SB11-I  
(Code No. 51799963) Italian

#### Specifications

- Ball size: 1/4"×11pcs
- Taper size: SUPERBE
- Thread: BC 1.37"×24T (English)  
36×24T (Italian)
- B.B. Width: 68mm, 70mm
- Weight: 309g

### 11 BOTTOM BRACKET (Microlite)

Model: BB-SB20-E  
(Code No. 51099901) English  
Model: BB-SB20-I  
(Code No. 51099903) Italian

#### Specifications

- Features: WTB/SUNTOUR Grease Guard System
- Taper size: SUPERBE
- Thread: BC 1.37"×24T (English)  
36×24T (Italian)
- B.B. Width: 68mm, 70mm
- Weight: 265g

### 12 BRAKE LEVER

Model: BL-SB11  
(Code No. 60019921)

#### Specifications

- Features: Balanced Response System
- Clamp Diameter: 23.8~24.2mm
- Weight: 236g/pr.

### BRAKE INNER OUTER SET

(Code No. 60999951)

### 13 BRAKE CALIPER

Model: BA-SB01-S  
F (Code No. 61999051)  
Front/Recessed  
R (Code No. 61999052)  
Rear/Recessed

#### Specifications

- Shoe adjustment range: 39~49mm
- Mounting: Recessed
- Weight: 362g/pr.

### 14 PEDAL

Model: PL-SB00  
(Code No. 53279931)

#### Specifications

- Thread: BC9/16"×20T (English)
- Weight: 290g/pr.

### 15 PEDAL

Model: PL-TM00  
(Code No. 53109901)

#### Specifications

- Features: Clipless mechanism
- Type: Road
- Thread: BC 9/16"×20T (English)
- Weight: 476g/pr.

### 16 HEAD SET

Model: HS-SB00-J  
(Code No. 50149901) JIS  
Model: HS-SB00-I  
(Code No. 50149913) English, Italian

#### Specifications

- Type: Road & Track
- Ball size: 5/32"×22pcs (W/Bearing retainer)
- Stack height: 37mm
- Weight: 119g

Type	Thread	Race Diameter	
		Upper Cone & Lower Cup	Lower Cone
J	JIS	30.0mm	27.0mm
I	English & Italian	BC1"×24T 30.2mm	26.4mm

### 17 SEAT POST

Model: SP-SB00-S  
(Code No. 53629662) 26.8mm/L=200mm  
(Code No. 53629668) 27.0mm/L=200mm  
(Code No. 53629672) 27.2mm/L=200mm  
Model: SP-SB00-L  
(Code No. 53629666) 26.8mm/L=250mm  
(Code No. 53629671) 27.0mm/L=250mm  
(Code No. 53629677) 27.2mm/L=250mm

#### Specifications

- Diameter: 25.0mm, 26.8mm,  
27.0mm, 27.2mm
- Saddle angle adjustment range:  
22-degree
- Saddle rail diameter: 7~8mm
- Weight: 250g (26.8mm/L=200mm)

## SUPERBE PRO TRACK



Favored by top track riders around the world, Superbe Pro track components over time have become the standard by which all others are judged.



### 1 CRANKSET

Model: CW-6000  
(Code No. 51479901) 49T/L=165mm

#### Specifications

- Taper size: SUPERBE
- Bolt circle diameter: 144mm
- Available chainrings: 44T~54T
- Thread: BC 1.37"×24T (English)
- Weight: 625g (49T/L=165mm)

### 2 PEDAL

Model: PL-2000  
(Code No. 53289931)

#### Specifications

- Thread: BC 9/16"×20T (English)
- Weight: 278g/pr.

### 3 HUB

Model: BH-1600  
(Code No. 52369439)  
Front, 32H/100mm  
(Code No. 52369425)  
Front, 28H/100mm  
(Code No. 52369465)  
Rear, 32H/120mm  
(Code No. 522369461)  
Rear, 28H/120mm  
Model: BH-1800  
(Code No. 52369275)  
Front, 36H/100mm  
(Code No. 52369571)  
Rear, 36H/120mm

#### Specifications

- Thread: BC 1.37"×24T (English)
- Weight: 545g/pr.

### 4 TRACK COG

Model: HC-100  
(Code No. 11720102) 12T, 1/8"  
(Code No. 11720112) 12T, 3/32"  
(Code No. 11730102) 13T, 1/8"  
(Code No. 11730112) 13T, 3/32"  
(Code No. 11740102) 14T, 1/8"  
(Code No. 11740112) 14T, 3/32"  
(Code No. 11750102) 15T, 1/8"  
(Code No. 11750112) 15T, 3/32"  
(Code No. 11760102) 16T, 1/8"  
(Code No. 11760112) 16T, 3/32"  
(Code No. 11770102) 17T, 1/8"  
(Code No. 11770112) 17T, 3/32"

#### Specifications

- Compatible chain: 1/2"×1/8"  
1/2"×3/32"
- Weight: 41g (14T)

### TRACK LOCK RING

Model: HC-900  
(Code No. 11727202) For 12T only  
(Code No. 11737202) For 13T~17T

#### Specifications

- Weight: 21g (12T)



# SANTOUR SL

An evolution of low weight and high performance

Designed for use where light-weight and high performance are critical, SL components are the choice of road racers and triathletes alike. Built with the demands of racing in mind, SL components offer compact size and a clean appearance.

## POWERING

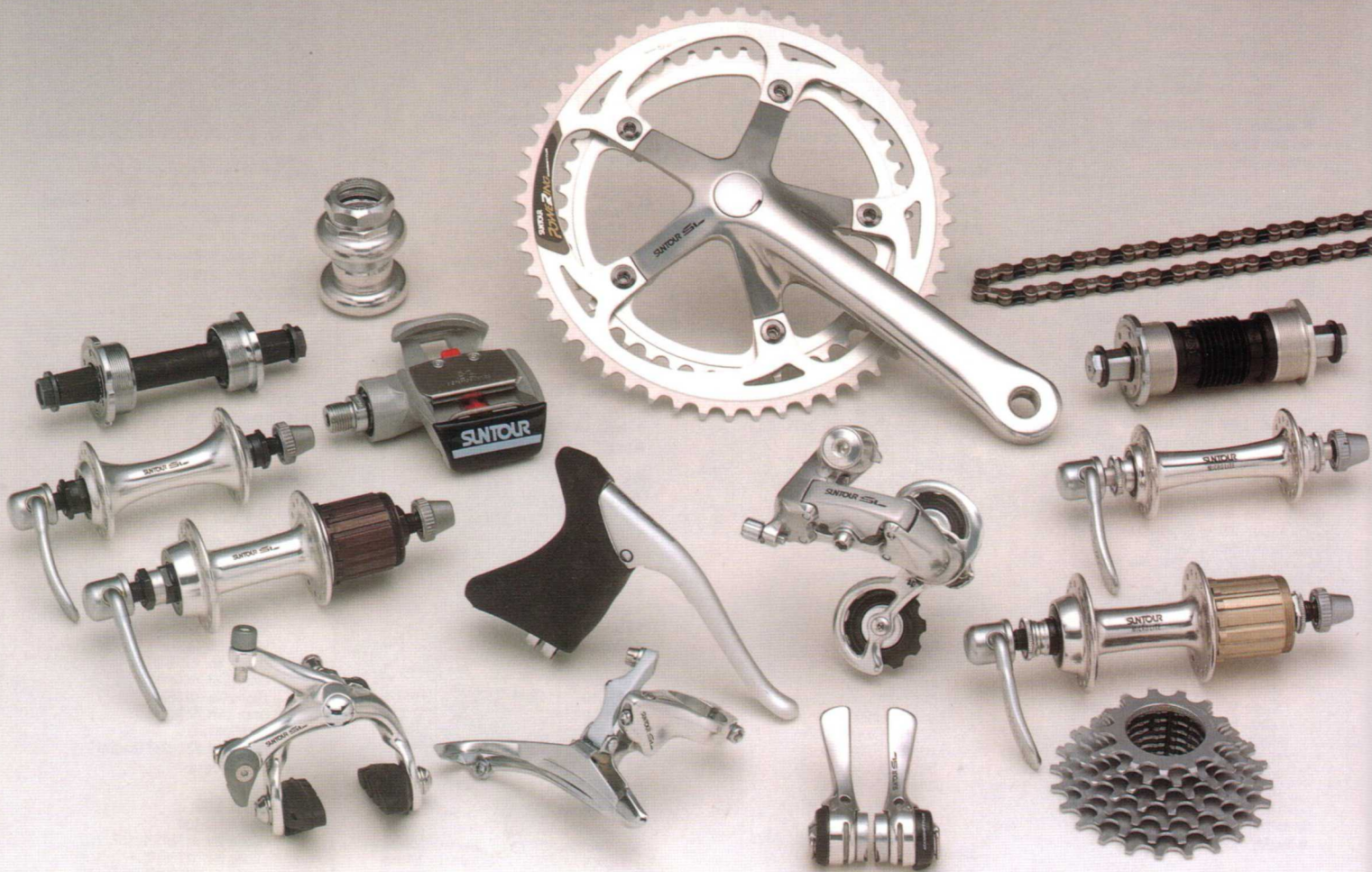

## MICRO LITE





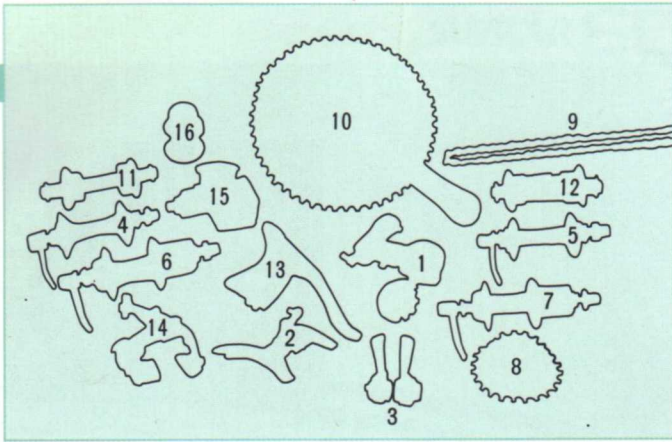

### 1 REAR DERAILLEUR

Model: RD-SL00-SSB  
(Code No. 23769921)

#### Specifications

- **ACCUSHIFT PLUS Compatible**
- **Largest rear Cog:** 24T (24mm dropout)
- **Total gear capacity:** 24T (Maximum chainring differential; 10T)
- **Weight:** 191g

### 2 FRONT DERAILLEUR

Model: FD-SL00-SSH  
(Code No. 29939911)  
Clamp-on/28.6mm  
(Code No. 29939913)  
Clamp-on/31.8mm  
Model: FD-SL00-SSB  
(Code No. 29939921)  
Braze-on

#### Specifications

- **Gear capacity:** 16T
- **Clamp diameter:** 1-1/8" (28.6mm)  
1-1/4" (31.8mm)
- **Weight:** 99g (Clamp-on)  
96g (Braze-on)

### 3 SHIFT LEVER (7 & 6-SPEED)

Model: SL-SL00-B  
(Code No. 32289841)  
Braze-on  
Model: SL-SL00-BF  
(Code No. 32289842)  
Braze-on/Aluminum frame  
Model: SL-SL00-C  
(Code No. 32289941)  
Clamp-on

#### Specifications

- **Clamp diameter:** 1-1/8" (28.6mm)
- **Weight:** 85g (Braze-on)  
101g (Clamp-on)

Standard	Inner Cable		Outer Casing	
	Type	Length	Type	Length
Right (Rear)	029	1,300mm	771	280mm
Left (Front)	029	800mm	771	—

### 4 FRONT HUB

Model: HB-SL01-F  
(Code No. 52629121) 32H/100mm  
(Code No. 52629131) 36H/100mm  
Quick release skewer  
(Code No. 50249222)

#### Specifications

- **Weight:** 221g (36H/100mm)

### 5 FRONT HUB (Microlite)

Model: HB-SL10-F  
(Code No. 52909111) 24H/100mm  
(Code No. 52909116) 28H/100mm  
(Code No. 52909121) 32H/100mm  
Quick release skewer  
(Code No. 50249222) For 100mm

#### Specifications

- **Weight:** 180g (32H/100mm)

### 6 FREEHUB (7-SPEED)

Model: FH-SL01-7  
(Code No. 47599941) 32H/126mm  
(Code No. 47599951) 36H/126mm  
(Code No. 47599943) 32H/130mm  
(Code No. 47599953) 36H/130mm  
Quick release skewer  
(Code No. 50249226) For 126mm  
(Code No. 50249227) For 130mm

#### Specifications

- **Weight:** 470g (36H/126mm)

### 7 FREEHUB (Microlite) (7-SPEED)

Model: FH-SL10-7  
(Code No. 47609931) 28H/126mm  
(Code No. 47609941) 32H/126mm  
(Code No. 47609933) 28H/130mm  
(Code No. 47609943) 32H/130mm  
Quick release skewer  
(Code No. 50249226) For 126mm  
(Code No. 50249227) For 130mm

#### Specifications

- **Weight:** 412g (32H/126mm)

### 8 CASSETTE COGS (7-SPEED)

Model: CS-AP00-S7  
(Code No. 47179802) Top/12T  
(Code No. 47179803) Top/13T  
Silver

#### Specifications

- **ACCUSHIFT PLUS Compatible**
- **Standard gear ratio (Weight):** 13×14×15×17×19×21×24T (257g)

### 9 CHAIN

Model: CH-AP11  
(Code No. 50550116)

#### Specifications

- **ACCUSHIFT PLUS Compatible**
- **Size:** 1/2"×3/32"
- **Pin width:** 7.3mm
- **Weight:** 325g (116 Links)

### 10 CRANKSET

Model: CW-SL00  
(Code No. 51439921)  
52T×42T/L=165.0mm  
(Code No. 51439929)  
52T×42T/L=170.0mm  
(Code No. 51439937)  
52T×42T/L=175.0mm

#### Specifications

- **Features:** PowerRing (52T×42T only)
- **Taper size:** VX
- **Bolt circle diameter:** 130mm
- **Available chainrings:** 53T, 52T, 42T, 39T
- **Thread:** BC 9/16"×20T
- **Weight:** 686g (52T×42T/L=170.0mm)

### 11 BOTTOM BRACKET

Model: BB-SL00-E  
(Code No. 51129901) English  
Model: BB-SL00-I  
(Code No. 51129903) Italian

#### Specifications

- **Ball size:** 1/4"×9pcs (W/bearing retainer)
- **Taper size:** VX
- **Thread:** BC 1.37"×24T (English)  
36×24T (Italian)
- **B.B. Width:** 68mm, 70mm
- **Weight:** 329g

### 12 BOTTOM BRACKET (Microlite)

Model: BB-SL10-E  
(Code No. 51109901) English  
Model: BB-SL10-I  
(Code No. 51109904) Italian

#### Specifications

- **Features:** WTB/SUNTOUR Grease Guard System
- **Taper size:** VX
- **Thread:** BC 1.37"×24T (English)  
36×24T (Italian)
- **B.B. Width:** 68mm
- **Weight:** 270g

### 13 BRAKE LEVER

Model: BL-SL00  
(Code No. 60059905)

#### Specifications

- **Clamp Diameter:** 23.8~24.2mm
- **Weight:** 260g/pr.

### BRAKE INNER OUTER SET

(Code No. 60999951)

### 14 BRAKE CALIPER

Model: BA-SL00-S  
F (Code No. 62199901)  
Front/Recessed  
R (Code No. 62199903)  
Rear/Recessed

#### Specifications

- **Shoe adjustment range:** 39~49mm
- **Mounting:** Recessed
- **Weight:** 290g/pr.

### 15 PEDAL

Model: PL-TM00  
(Code No. 53109901)

#### Specifications

- **Features:** Clipless mechanism
- **Type:** Road
- **Thread:** BC9/16"×20T (English)
- **Weight:** 476g/pr.

### 16 HEAD SET

Model: HS-ST00-J  
(Code No. 50049901) JIS  
Model: HS-ST00-I  
(Code No. 50049911) English, Italian

#### Specifications

- **Type:** Road
- **Ball size:** 5/32"×20pcs (w/Bearing retainer)
- **Stack height:** 38.1mm
- **Weight:** 122g

Type	Thread	Race Diameter	
		Upper Cone & Lower Cup	Lower Cone
J	JIS	30.0mm	27.0mm
I	English & Italian	BC1"×24T	30.2mm 26.4mm

Photo/'91 TOUR DE FRANCE.

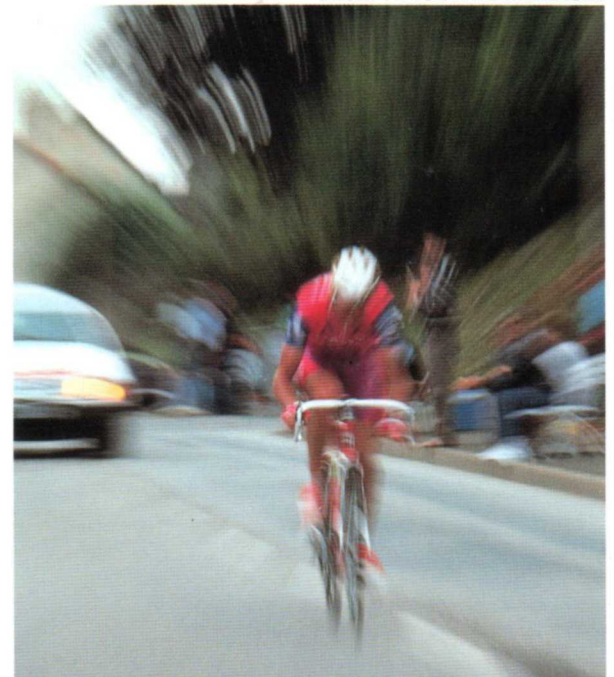

Shown here is a representative selection of this component. The specifications of other products are also listed.



# SUNTOUR RADIUS

## Streamlined performance

Utilizing the same standards as other SUNTOUR components, Radius is both light in weight and functional. A sleek, clean appearance combined with versatility makes these components ideal entry-level racers and sport riders.

### POWERING



#### 1 REAR DERAILLEUR

Model: RD-RA00-SSB  
(Code No. 23359921)

##### Specifications

- ACCUSHIFT PLUS Compatible
- Largest rear sprocket: 28T (28mm dropout)
- Total gear capacity: 28T (Maximum chainring differential: 13T)
- Weight: 257g

#### 2 FRONT DERAILLEUR

Model: FD-RA00-SSH  
(Code No. 29009911)  
Clamp-on/28.6mm  
(Code No. 29009913)  
Clamp-on/31.8mm  
Model: FD-RA00-SSB  
(Code No. 29009921)

##### Braze-on

##### Specifications

- Gear capacity: 16T
- Clamp diameter: 1-1/8" (28.6mm)  
1-1/4" (31.8mm)
- Weight: 99g (Clamp-on)  
96g (Braze-on)

#### 3 SHIFT LEVER (7 & 6-SPEED)

Model: SL-RA00-B  
(Code No. 32409841)

##### Braze-on

Model: SL-RA00-BF  
(Code No. 32409842)

Braze-on/Aluminum frame

Model: SL-RA00-C  
(Code No. 32409941)

##### Clamp-on

##### Specifications

- ACCUSHIFT PLUS Compatible
- Clamp diameter: 1-1/8" (28.6mm)
- Weight: 81g (Braze-on)  
101g (Clamp-on)

	Inner Cable		Outer Casing	
	Type	Length	Type	Length
Right (Rear)	029	1,300mm	771	280mm
Left (Front)	029	800mm	771	—

#### 4 FRONT HUB

Model: HB-RA01-F  
(Code No. 52979122) 32H/100mm  
(Code No. 52979132) 36H/100mm  
Quick release skewer  
(Code No. 50249192)

##### Specifications

- Weight: 240g (36H/100mm)

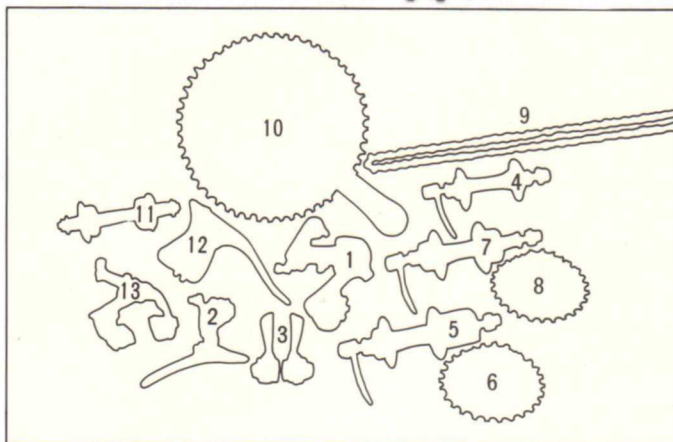

Photo/'91 TOUR DE FRANCE.

#### 5 FREEHUB (7-SPEED)

Model: FH-RA01-7  
(Code No. 47759962) 32H/126mm  
(Code No. 47759972) 36H/126mm  
Quick release skewer  
(Code No. 50249196) For 126mm

##### Specifications

- Weight: 471g (36H/126mm)

#### 6 CASSETTE COGS (7-SPEED)

Model: CS-AP00-K7  
(Code No. 47179702) Top/12T  
(Code No. 47179703) Top/13T  
Black

##### Specifications

- ACCUSHIFT PLUS Compatible
- Standard gear ratio (Weight):  
13×14×15×17×20×23×26T (286g)  
13×15×17×19×21×24×28T (329g)



## POWERING



### 7 REAR HUB

Model: HB-RA01-R  
(Code No. 52979221) 32H/126mm  
(Code No. 52979231) 36H/126mm  
Quick release skewer  
(Code No. 50249196) For 126mm

#### Specifications

- Thread: BC 1.37"×24T
- "D" dimension: 37mm (126mm)
- Weight: 331g (36H/126mm)

### 8 FREEWHEEL (7-SPEED)

Model: FW-AL10-K7  
(Code No. 15079703)  
Black

#### Specifications

- ACCUSHIFT PLUS Compatible
- Thread: BC 1.37"×24T
- Compatible hub "D" dimension: 37mm
- Standard gear ratio (Weight):  
13×14×15×17×20×23×26T (427g)  
13×15×17×19×21×24×28T (483g)

### 9 CHAIN

Model: CH-AP20  
(Code No. 50690116)  
Black & Black

#### Specifications

- ACCUSHIFT PLUS Compatible
- Size: 1/2"×3/32"
- Pin width: 7.3mm
- Weight: 325g (116 Links)

### 10 CRANKSET

Model: CW-RA01  
(Code No. 51609831)  
52T×42T/L=165.0mm  
(Code No. 51609835)  
52T×42T/L=170.0mm

#### Specifications

- Features: PoweRing (52T×42T only)
- Taper size: VX
- Bolt circle diameter: 130mm
- Available chainrings: 52T, 42T
- Thread: BC 9/16"×20T
- Weight: 700g (52T×42T/170.0mm)

### 11 BOTTOM BRACKET

Model: BB-RA01-E  
(Code No. 51019921) English  
Model: BB-RA01-I  
(Code No. 51019923) Italian

#### Specifications

- Ball size: 1/4"×9pcs (W/bearing retainer)
- Taper size: VX
- Thread: BC 1.37"×24T (English)  
36×24T (Italian)
- B.B. Width: 68mm, 70mm
- Weight: 350g

### 12 BRAKE LEVER <Dia-compe>

Model: BL-RA00-S  
(Code No. 60039903) Short  
Model: BL-RA00-N  
(Code No. 60039901) Standard

#### Specifications

- Features: Balanced Response System
- Clamp Diameter: 23.8~24.2mm
- Weight: 228g/pr.

### BRAKE INNER OUTER SET

(Code No. 60999976)

### 13 BRAKE CALIPER <Dia-compe>

Model: BA-RA01-S  
F (Code No. 62049931)  
Front/Recessed  
R (Code No. 62049933)  
Rear/Recessed

#### Specifications

- Features: Balanced Response System
- Shoe adjustment range: 40~52mm
- Mounting: Recessed type
- Weight: 290g/pr.

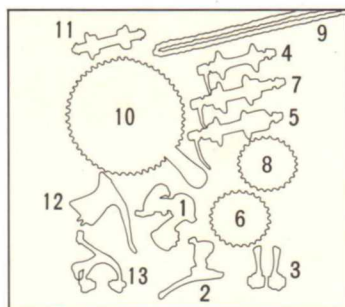

### 1 REAR DERAILLEUR

Model: RD-ED01-SSB  
(Code No. 23819921)

### 2 FRONT DERAILLEUR

Model: FD-ED01-SSH  
(Code No. 29949911)  
Clamp-on/28.6mm  
(Code No. 29949913)  
Clamp-on/31.8mm

### 3 SHIFT LEVER (7-SPEED)

Model: SL-ED00-B7  
(Code No. 32509841)  
Brazo-on  
Model: SL-ED00-B7F  
(Code No. 32509843)  
Brazo-on/Aluminum frame  
Model: SL-ED00-C7  
(Code No. 32509941)  
Clamp-on/28.6mm

### 4 FRONT HUB

Model: HB-RA01-F  
(Code No. 52979122) 32H/100mm  
(Code No. 52979132) 36H/100mm  
Quick release skewer  
(Code No. 50249192)

### 5 FREEHUB (7-SPEED)

Model: FH-RA01-7  
(Code No. 47759962) 36H/126mm  
(Code No. 47759972) 36H/126mm  
Quick release skewer  
(Code No. 50249196) For 126mm

### 6 CASSETTE COGS (7-SPEED)

Model: CS-AP00-K7  
(Code No. 47179702) Top/12T  
(Code No. 47179703) Top/13T  
Black

### 7 REAR HUB

Model: HB-RA01-R  
(Code No. 52979221) 32H/126mm  
(Code No. 52979231) 36H/126mm  
Quick release skewer  
(Code No. 50249196) For 126mm

### 8 FREEWHEEL (7-SPEED)

Model: FW-AL10-K7  
(Code No. 15079703)  
Black

### 9 CHAIN

Model: CH-AP20  
(Code No. 50690116)  
Black & Black

### 10 CRANKSET

Model: CW-ED01  
(Code No. 51729731)  
52T×42T/L=165.0mm  
(Code No. 51729735)  
52T×42T/L=170.0mm

### 11 BOTTOM BRACKET

Model: BB-RA01-E  
(Code No. 51019921) English  
Model: BB-RA01-I  
(Code No. 51019923) Italian

### 12 BRAKE LEVER <Dia-compe>

Model: BL-ED00-S  
(Code No. 60139903)  
Model: BL-ED00-N  
(Code No. 60139901)

### 13 BRAKE CALIPER <Dia-compe>

Model: BA-ED00-S  
F (Code No. 62149001)  
Front  
R (Code No. 62149903)  
Rear



# SUNTOUR BLAZE



## LITE OPERATION POWERING

**1 REAR DERAILLEUR**  
Model: RD-BE02-SSB  
(Code No. 23879921)

**2 FRONT DERAILLEUR**  
Model: FD-BE02-SSH  
(Code No. 29239911)  
Clamp-on/28.6mm  
(Code No. 29239913)  
Clamp-on/31.8mm

**3 SHIFT LEVER (7-SPEED)**  
Model: SL-BE02-B7  
(Code No. 32619841)  
Braze-on  
Model: SL-BE02-C7  
(Code No. 32619842)  
Clamp-on/28.6mm

**4 SHIFT LEVER (7-SPEED)**  
Model: SL-BE02-CP7  
(Code No. 34129941)  
Stem mount/22.2mm

**5 FRONT HUB**  
Model: HB-RA01-F  
(Code No. 52979122) 32H/100mm  
(Code No. 52979132) 36H/100mm  
Quick release skewer  
(Code No. 50249192)

**6 REAR HUB**  
Model: HB-RA01-R  
(Code No. 52979221) 32H/126mm  
(Code No. 52979231) 36H/126mm  
Quick release skewer  
(Code No. 50249196) For 126mm

**7 FREEWHEEL (7-SPEED)**  
Model: FW-AL10-K7  
(Code No. 15079703)  
Black

**8 CHAIN**  
Model: CH-AP20  
(Code No. 50690116)  
Black & Black

**9 CRANKSET**  
Model: CW-BE01  
(Code No. 51719731)  
52T×42T/L=165.0mm  
(Code No. 51719735)  
52T×42T/L=170.0mm

**10 BOTTOM BRACKET**  
Model: BB-RA01-E  
(Code No. 51019921) English  
Model: BB-RA01-I  
(Code No. 51019923) Italian

**11 BRAKE LEVER <Dia-compe>**  
Model: BL-BE00-S  
(Code No. 60149911)  
Model: BL-BE00-N  
(Code No. 60149901)

**12 BRAKE CALIPER <Dia-compe>**  
Model: BA-BE00-S  
F (Code No. 62159001)  
Front/Recessed  
R (Code No. 62159003)  
Rear/Recessed  
Model: BA-BE00-N  
F (Code No. 62159011)  
Front/Recessed  
R (Code No. 62159013)  
Rear/Recessed

# SUNTOUR VX



## LITE OPERATION POWERING

**1 REAR DERAILLEUR**  
Model: RD-VX02-SSB  
(Code No. 23909921)  
W/O Bracket  
Model: RD-VX02-SSZ  
(Code No. 23909901)  
W Bracket

**2 FRONT DERAILLEUR**  
Model: FD-BE02-SSH  
(Code No. 29239911)  
Clamp-on/28.6mm  
(Code No. 29239913)  
Clamp-on/31.8mm

**3 SHIFT LEVER (7-SPEED)**  
Model: SL-BE02-B7  
(Code No. 32619841)  
Braze-on  
Model: SL-BE02-C7  
(Code No. 32619842)  
Clamp-on/28.6mm

**4 SHIFT LEVER (7-SPEED)**  
Model: SL-BE02-CP7  
(Code No. 34129941)  
Stem mount/22.2mm

**5 FREEWHEEL (7-SPEED)**  
Model: FW-AL10-K7  
(Code No. 15079703)  
Black

**6 CHAIN**  
Model: CH-AP20  
(Code No. 50690116)  
Black & Black

**7 CRANKSET <SR>**  
Model: CW-VX01  
(Code No. 51389801)  
52T×42T/L=165.0mm  
(Code No. 51319803)  
52T×42T/L=170.0mm

**8 BOTTOM BRACKET <SR>**  
Model: BB-VX01-E  
(Code No. 51039921)

**9 BRAKE LEVER <Dia-compe>**  
Model: BL-VX00-N  
(Code No. 60159901)

**10 BRAKE CALIPER <Dia-compe>**  
Model: BA-VX00-N  
F (Code No. 62169001)  
Front  
R (Code No. 62169003)  
Rear



# SUNTOUR RT



## LITE OPERATION POWERING

**1 REAR DERAILLEUR**  
Model: RD-RT01-SSB  
(Code No. 82249911)  
W/O Bracket  
Model: RD-RT01-SSZ  
(Code No. 82249901)  
W Bracket

**2 FRONT DERAILLEUR**  
Model: FD-RT01-SSH  
(Code No. 82899911)  
Clamp-on/28.6mm

**3 SHIFT LEVER (7-SPEED)**  
Model: SL-RT01-B7  
R (Code No. 83149012)  
L (Code No. 83149021)

**4 FREEWHEEL (7-SPEED)**  
Model: FW-AL10-K7  
(Code No. 15079703)  
Black

**5 CHAIN**  
Model: CH-AP20  
(Code No. 50690116)  
Black & Black

**6 CRANKSET <SR>**  
Model: CW-RT00  
(Code No. 51459921)  
52T×42T/L=165.0mm  
(Code No. 51459929)  
52T×42T/L=170.0mm

**7 BOTTOM BRACKET <SR>**  
Model: BB-VX01-E  
(Code No. 51039921)

**8 BRAKE LEVER <Dia-compe>**  
Model: BL-RT00-N  
(Code No. 60429901)

**9 BRAKE CALIPER <Dia-compe>**  
Model: BA-RT00-N  
F (Code No. 62209901)  
Front  
R (Code No. 62209003)  
Rear

Photo/'91 TOUR DE FRANCE.





# MICRO LITE



**FRONT HUB <SL>**  
 Model: HB-SL10-F  
 (Code No. 52909111) 24H/100mm  
 (Code No. 52909116) 28H/100mm  
 (Code No. 52909121) 32H/100mm  
 Quick release skewer  
 (Code No. 50249222)  
 Specifications  
 ● Weight: 180g



**FREE HUB <SL>**  
 Model: FH-SL10-7  
 (Code No. 47609931) 28H/126mm  
 (Code No. 47609941) 32H/126mm  
 (Code No. 47609933) 28H/130mm  
 (Code No. 47699943) 32H/130mm  
 Quick release skewer  
 (Code No. 50249226) For 126mm  
 (Code No. 50249227) For 130mm  
 Specifications  
 ● Weight: 412g



**BOTTOM BRACKET**  
 [SUPERBE-PRO]  
 Model: BB-SB20-E  
 (Code No. 51099901) English  
 Model: BB-SB20-I  
 (Code No. 51099903) Italian  
 [SL][XC-PRO<MD>]  
 Model: BB-SL10-E  
 (Code No. 51109901) English  
 Model: BB-SL10-I  
 (Code No. 51109904) Italian

Specifications  
 ● Features:  
 WTB/SUNTOUR Grease Guard System  
 ● Taper size: SUPERBE (SUPERBE-PRO)  
 VX (SL)  
 ● Thread: BC 1.37"×24T (English)  
 36×24T (Italian)  
 ● B.B. Width: 68mm (English),  
 70mm (Italian)  
 ● Weight: 265g (SUPERBE-PRO)  
 270g (SL)



**COMMAND SHIFTER**  
 Model: SL-CD01-R7  
 (Code No. 32219911)  
 Right/Index  
 Model: SL-CD01-L  
 (Code No. 32219921)  
 Left/Power  
 Specifications  
 ● ACCUSHIFT PLUS Compatible  
 ● Mounting position: Handlebar  
 ● Weight: 185g

Standard	Type	Inner Cable		Outer Casing	
		Length	Type	Length	Type
Right (Rear)	029	2,000mm	751	600×280mm	
Left (Front)	029	1,500mm	751	600mm	



**CABLE CASING STOP**  
 Model: OS-410  
 (Code No. 55319901)  
 Specifications  
 ● Material: Aluminum alloy (Body)  
 Steel (Mounting bolt & adjuster)  
 ● Use: Downtube casing stop

**BAR-END CONTROL**  
 Model: SL-BC01-R7  
 (Code No. 31269913)  
 Right/Index  
 Model: SL-BC01-L  
 (Code No. 31269921)  
 Left/Power  
 Specifications  
 ● ACCUSHIFT PLUS Compatible  
 ● Clamp diameter: 18.8~22.2mm  
 ● Weight: 188g



**VICE GRIPS**  
 Model: OT-GP10  
 (Code No. 59040703)  
 Specifications  
 ● Weight: 98g/pr.

**SEAT POST BINDER**  
 Model: SB-XP00  
 (Code No. 50279903)  
 Specifications  
 ● Useful skewer length: 18~38.5mm  
 ● Weight: 50g



**STAINLESS STEEL INNER CHAINRING**  
 Model: CR-ST00  
 (Code No. 51750024)  
 Specifications  
 ● Material: Stainless steel  
 ● Pitch circle diameter: 74mm  
 ● Size: 24T

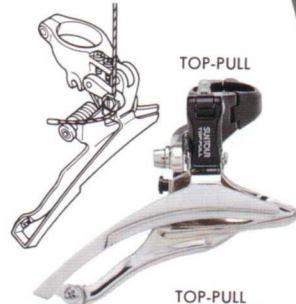

**FRONT DERAILLEUR (TOP-PULL-PRO)**  
 Model: FD-TP10-GXH  
 (Code No. 29829811)  
 Clamp-on/28.6mm  
 (Code No. 29829813)  
 Clamp-on/31.8mm  
 (Code No. 29829815)  
 Clamp-on/34.9mm  
 Specifications  
 ● Gear capacity: 24T  
 ● Chaining differential: 7~11T (Outer~center)  
 1-1/4" (31.8mm)  
 1-3/8" (34.9mm)  
 ● Weight: 115g/1-1/8" (28.6mm)

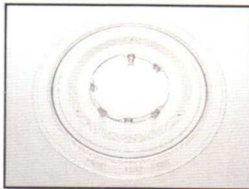

**SPOKE DISC (FOR FREEHUB)**  
 Model: FH-SD28  
 (Code No. 56170131) For 32H  
 (Code No. 56170132) For 36H  
 5-3/4" (147mm)  
 Model: FH-SD34  
 (Code No. 56170141) For 32H  
 (Code No. 56170142) For 36H  
 7-3/20" (186mm)  
 Specifications  
 ● Material: Plastic  
 ● Diameter: 5-3/4" (147mm)  
 7-3/10" (186mm)  
 ● Use range: Maximum 28T (Model: FH-SD28)  
 Maximum 34T (Model: FH-SD34)



**FRONT DERAILLEUR (TOP-PULL)**  
 Model: FD-TP00-GXH  
 (Code No. 29889911)  
 Clamp-on/28.6mm  
 (Code No. 29889915)  
 Clamp-on/31.8mm  
 (Code No. 29889917)  
 Clamp-on/34.9mm  
 Specifications  
 ● Gear capacity: 24T  
 ● Chaining differential: 7~11T (Outer~center)  
 ● Clamp diameter: 1-1/8" (28.6mm)  
 1-1/4" (31.8mm)  
 1-3/8" (34.9mm)  
 ● Weight: 116g/1-1/8" (28.6mm)

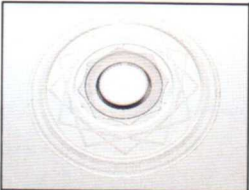

**SPOKE DISC (FOR REAR HUB)**  
 Model: SD-100  
 (Code No. 56170111)  
 5-3/4" (147mm)  
 Model: SD-110  
 (Code No. 56170121)  
 7" (176mm)  
 Specifications  
 ● Material: Plastic (disc)  
 Aluminum (body)  
 ● Diameter: 5-3/4" (147mm)  
 7" (176mm)  
 ● Use range: Maximum 28T (Model: SD-100)  
 Maximum 34T (Model: SD-110)



**FRONT DERAILLEUR (TOP-PULL-LITE)**  
 Model: FD-TP05-GXH  
 (Code No. 29829711)  
 Clamp-on/28.6mm  
 (Code No. 29829713)  
 Clamp-on/31.8mm  
 Specifications  
 ● Gear capacity: 24T  
 ● Chaining differential: 7~11T (Outer~center)  
 ● Clamp diameter: 1-1/8" (28.6mm)  
 1-1/4" (31.8mm)  
 ● Weight: 124g/1-1/8" (28.6mm)



**FRONT DERAILLEUR (BRAZE-ON)**  
 Model: FD-BR01-GXB  
 (Code No. 29919821)  
 Specifications  
 ● Gear capacity: 24T  
 ● Chaining differential: 7~11T (Outer~center)  
 ● Weight: 120g



**TRANSVERSE CABLE STOP**  
 Model: OT-SH00  
 (Code No. 62685401)  
 Specifications  
 ● Material: Steel  
 ● Use: Prevents the transverse cable from interfering with the wheel.

# SUNTOUR SCRAMBLER

**REAR DERAILLEUR**  
 Model: RD-SR21-SSB  
 (Code No. 22359921)  
 W/Bracket  
 Model: RD-SR21-SSZ  
 (Code No. 22359901)  
 W/Bracket  
 Model: RD-SR21-GTB  
 (Code No. 22369921)  
 W/Bracket  
 Model: RD-SR21-GTZ  
 (Code No. 22369901)  
 W/Bracket  
 Model: RD-SR21-GXB  
 (Code No. 22379921)  
 W/Bracket  
 Model: RD-SR21-GXZ  
 (Code No. 22379901)  
 W/Bracket  
 Specifications  
 ● ACCUSHIFT PLUS Compatible  
 ● Largest rear cog:  
 SS & GT 28T (28mm dropout)  
 GX 32T (28mm dropout)  
 ● Total gear capacity:  
 SS: 28T (Maximum chaining differential: 12T)  
 GT: 34T (Maximum chaining differential: 18T)  
 GX: 40T (Maximum chaining differential: 20T)  
 ● Weight: 255g (SS)  
 275g (GT)  
 283g (GX)



**SEALED CARTRIDGE BEARING PULLEY SET**  
 Model: BP-100  
 (Code No. 59999911)  
 Specifications  
 ● Material: Delrin  
 ● Use: Rear derailleur





**WHEEL COVER**  
Model: PE-1500  
(Code No. 59021701)  
Specifications  
● Material: stretch nylon  
● Fitting wheel size: 700c  
● Color: Blue



**CAP**  
Model: OG-YC00  
(Code No. 59030703)  
Specifications  
● Material: Nylon 80% Cotton 20%  
● Size: One size fits all  
● Color: Day-glo yellow

**SCOPE LIGHT KIT**  
Model: OT-SC00-Q  
(Code No. 51329936)  
Light & Holder set/For QR  
Model: OT-SC10  
(Code No. 51329930)  
Holder (QR) only  
Specifications  
● Material: Aluminum alloy  
● Battery: "AA" alkaline × 2pcs.  
● Maximum intensity of illumination:  
27 Lux (W/2.2 volt bulb)  
● Use: Quick release hub

**SCOPE LIGHT KIT**  
Model: OT-SC00-H  
(Code No. 51329937)  
Light & holder set/For handlebar  
Model: OT-SC20  
(Code No. 51329931)  
Holder (handlebar) only  
Specifications  
● Material: Aluminum alloy  
● Battery: "AA" alkaline × 2 pcs.  
● Maximum intensity of illumination:  
27 Lux (W/2.2 volt bulb)  
● Use: Handlebar  
● Clamp diameter: 22.2mm, 25.4~26.2mm



**CHAINSTAY PROTECTOR**  
Model: OT-CP00  
(Code No. 59050321)  
Specifications  
● Material: Vinyl  
● Use: Protects chainstay  
● Color: Black



**CYCLE BANDANA**  
Model: PE-2200  
(Code No. 59032503) Blue  
(Code No. 59032501) Red  
Specifications  
● Material: Cotton  
● Size: 520 × 520mm  
● Color: Blue; Red

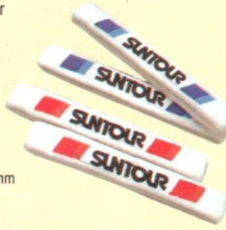

**HEAD BAND**  
Model: PE-2100  
(Code No. 59032303) Blue  
(Code No. 59032301) Red  
Specifications  
● Material: Cotton  
● Size: One size fits all  
● Color: Blue; Red



**WATER BOTTLE**  
Model: PE-1200  
(Code No. 59040313) Large/Blue  
(Code No. 59040311) Large/Red  
(Code No. 59040303) Small/Blue  
(Code No. 59040301) Small/Red  
Specifications  
● Material: Polyethylene  
● Capacity: 750ml (Large)  
500ml (Small)  
● Color: Blue & Red



**SHOULDER HOLDER**  
Model: OG-SH00  
(Code No. 59020341)  
Specifications  
● Material: Nylon  
● Size: 240×240×50mm  
● Color: Black



**APRON**  
Model: PE-1800  
(Code No. 59032101)  
Specifications  
● Material: cotton  
● Size: on size fits all  
● Color: red

# SUNTOUR COMPONENT SYSTEM CHART

## ATB & Hybrid Bike

**EXPLANATORY NOTES**  
[SR] Self Energizing System  
[GGS] Grease Guard System  
[ML] Microlite  
[LP] Low Profile Model  
[DC] Dia-Compe Product  
[SR] Sakae Ringyo Product

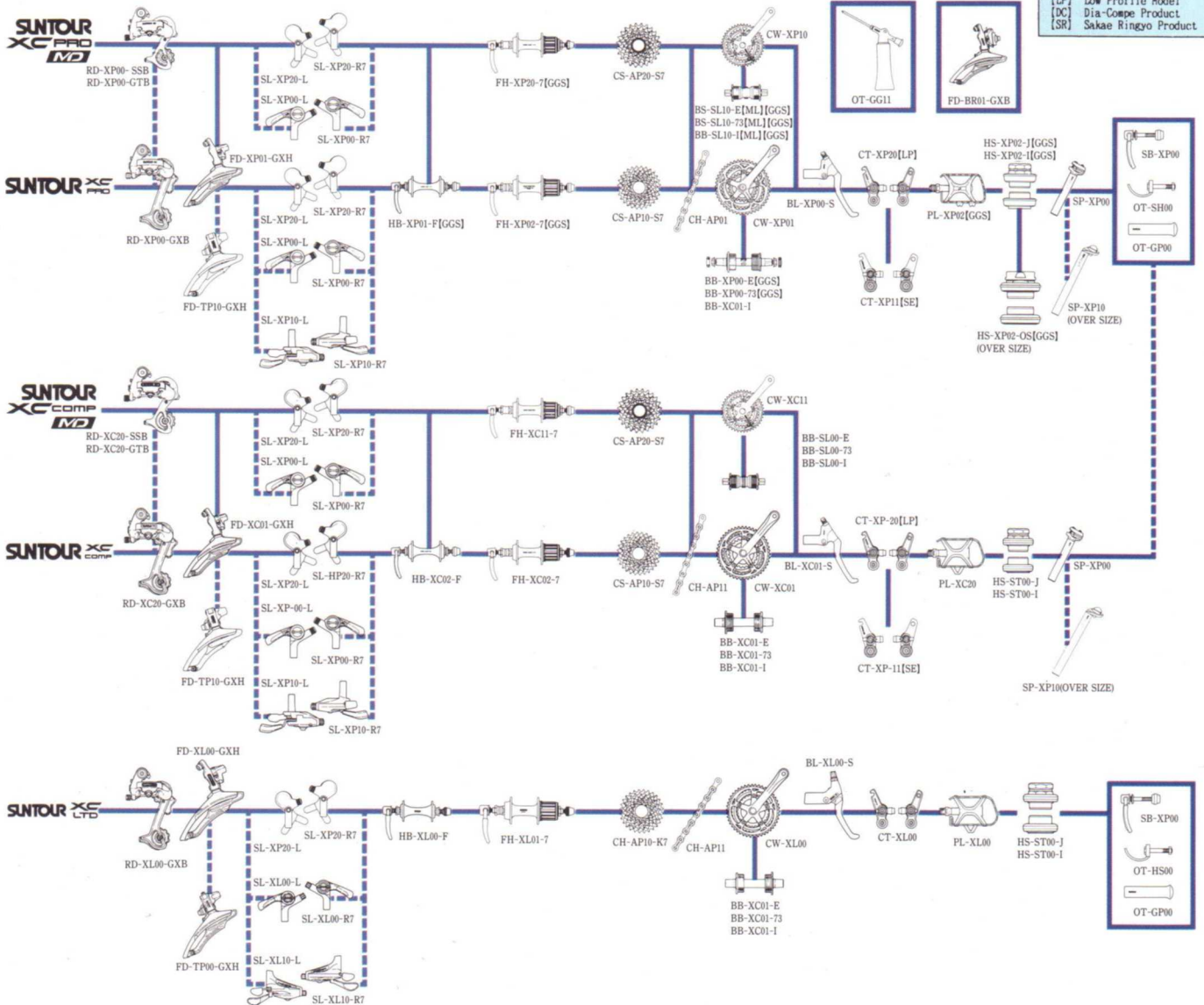





**CHAIN TOOL**  
 Model: TA-330  
 (Code No. 58129946)  
 Specifications  
 ● Material: Steel (Chromium plated)



**FREEWHEEL REMOVER**  
 Model: TA-320  
 (Code No. 58120126)  
 Specifications  
 ● Material: Forged steel  
 ● Use: Winner & AP freewheel



**GREASE GUN KIT**  
 (GREASE GUN & GREASE)  
 (WTB/SUNTOUR GREASE GUARD SYSTEM)  
 Model: OT-GG11  
 (Code No. 58129985)

**GREASE (GREASE ONLY)**  
 Model: OT-GG01  
 (Code No. 58129984)

**FREEWHEEL & HUB VICE**  
 Model: TA-120  
 (Code No. 58129942)  
 Specifications

● Material:  
 Steel (Black & Uni chromium plated)  
 ● Use: Freewheel cog

**COG REMOVER**  
 Model: TA-131  
 (Code No. 58129951)  
 For 1/2" x 3/32" chain  
 Model: TA-130  
 (Code No. 58129950)  
 For 1/2" x 1/8" chain  
 Specifications  
 ● Material: Steel  
 Use: Freewheel & cassette cog  
 (Model: TA-131)  
 Track cog (Model: TA-130)

**CABLE CUTTER**  
 Model: TA-110  
 (Code No. 58129960)  
 Specifications  
 ● Material: Steel (Black plated)

**BOX WRENCH**  
 Model: TA-240  
 (Code No. 58120185)  
 Specifications  
 ● Material: Steel (Chromium plated)  
 ● Size: 14mm & 15mm

**OPEN END WRENCH**  
 Model: TA-190  
 (Code No. 58120173)  
 Specifications  
 ● Material: Steel (Chromium finish)  
 ● Size: 16mm & 19mm

**BEARING TOOL**  
 Model: TA-340  
 (Code No. 58120213)  
 Specifications  
 ● Material: Steel  
 ● Use: Sealed bearing hub

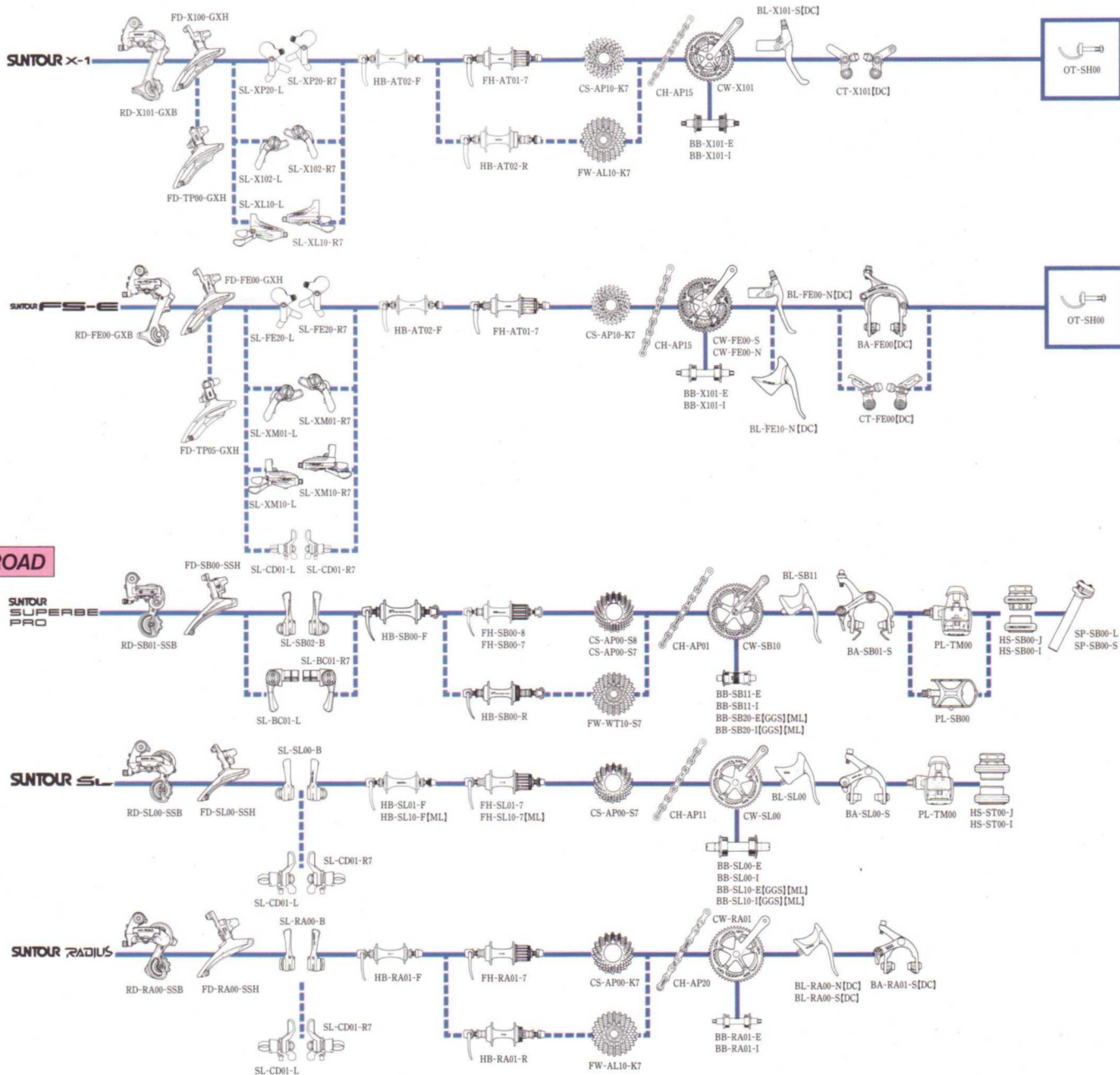





We make bicycle components as though we're coming along for the ride.

**MAEDA INDUSTRIES, LTD.**

97 Tannan Mihara-Cho,  
Minamikawachi-Gun, Osaka 587 Japan  
TEL (0723) 61-1300 FAX (0723) 61-2300

SUNTOUR USA (SR USA INC.)  
18650 72nd Avenue South Kent, WA 98032 U.S.A.

SUNTOUR EUROPE (MAEDA INDUSTRIES, LTD.)  
25, Rue Tenbosch 1050 Bruxelles Belgique

