

 **NORCO**[®]

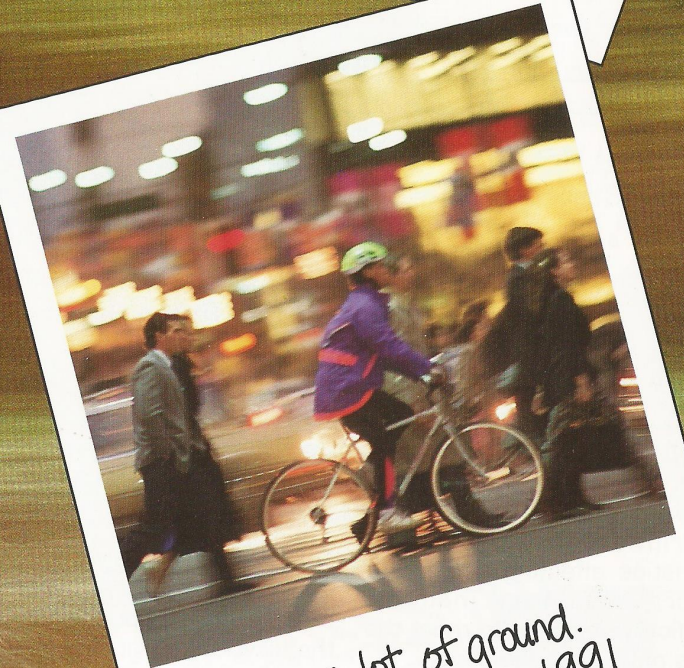

from recreation to racing...



*We cover a lot of ground.
1991*

FRAME INFORMATION



Top-tube mounted open cables reduce friction in the front and rear changer cables and result in increased power to the rear brake by reducing casing compression.



New Shimano Deore XT ST1 Rapid Fire levers with single step-down front shifting and the new Servo Wave brake mechanism for fast cable pick up and improved braking response.

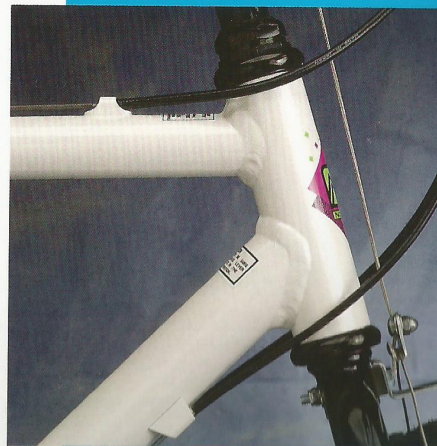

Lightweight, durable T7000 aluminum tig welded off-road frame produces a very rigid, responsive ride. Oversize head-set for prolonged bearing life.

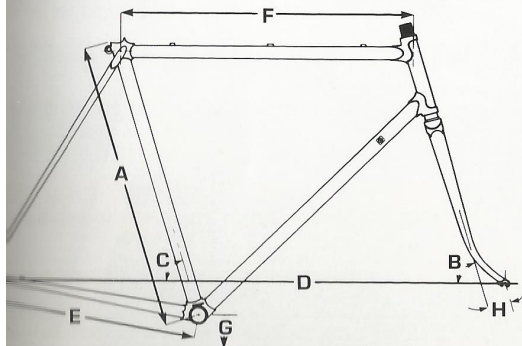

	A	B	C	D	E	F	G	H
RAMPAGE	470	70	74	1056	432	560	290	45
MAGNUM	481	70	73	1040	425	540	293	45
SASQUATCH	520	71	73	1062	442	570	290	45
PINNACLE	517	71	74	1060	425	550	282	45
KOKANEE	515	71	73	1060	430	560	290	45
EUROSPORT	570	74	74	1000	410	569	265	45

- A SEAT-TUBE (mm)
- B HEAD-TUBE (°)
- C SEAT-TUBE (°)
- D WHEEL BASE (mm)
- E CHAIN-STAY LENGTH (mm)
- F TOP-TUBE LENGTH (mm)
- G B.B. HEIGHT (mm)
- H FORK RAKE (mm)

FRAME INFORMATION

outlined below is a brief description of the key characteristics affecting a bicycle's performance. Each model is specifically designed to meet the needs of its intended user.

The seat-tube length determines

the bike, as it governs the height of the top-tube from the ground.

The *head-tube angle* and *seat-tube angle* contribute to the control and responsiveness of the bicycle. Low angles generally produce a very smooth stable ride (especially at higher

bike capable of more technical riding (e.g. twisting trails, or high performance road riding).

The *wheel base* and *chain-stay length* also affect the handling of the bicycle. Generally, a long wheel-base or chain-stay produces a stable ride in addition to providing some road

more agile responsive feel.

Bottom bracket height governs the centre of gravity of the bicycle and determines overall ground clearance.

For more detailed discussion of frame characteristics, consult your local NORCO dealer.

NORCO . . .
from recreation
to racing we
cover a lot of
ground.

Our 1991 line represents our continued commitment to producing high quality value packed bicycles for the whole family. From sturdy 20" wheel children's bikes to hi-tech racing equipment, we cover the full spectrum.

We have continued to provide our customers with no holds barred high-end products like the 1991 Rampage. Crafted in Japan from lightweight Tange Prestige chromo-moly tubing, this race prepped unit features the latest shifting and braking innovations from Shimano.

Our children's line has been expanded to meet the needs of the active youth market, and we are pleased to present three new models in our Hybrid mountain-lite program.

Visit your local NORCO dealer today for all the



RAMPAGE PRESTIGE
Tested and
perfected for off-
road radicals.

The Rampage has been redesigned for 1991 and incorporates a longer top-tube and Tange Switch-blade forks. Featherweight, yet durable, this Tange Prestige frame delivers an agile, responsive ride. Key features include: new Deore XT Rapid Fire shifters with single step-down shifts, Servo Wave brake levers for faster cable pick up, Bullet proof Araya RM-17 rims and ultra aggressive Panaracer Smoke tires.

PAGE

PRESTIGE



MAGNUM
Master the
extreme.

This heat treated T-7000 tig welded oversized frame doesn't sacrifice strength or performance for weight reduction. Deore DX 21-speed Rapid Fire is equipped with Hyperglide shifting and round Superglide chainrings, durable Araya CV-7 welded rims with concave sidewalls for improved brake pad line-up, ground hugging Tioga Mud Dawg tires.

MAGNUM

SASQUATCH
Bred to shred.

The full Tange chromoly Sasquatch is built for the challenge and utilizes a sleek long radius tapered tubular fork. Note the refined Suntour XC LTD components featuring X-press below bar shifting, durable Accushift Plus freewheel cogs and powerful balanced response canti-levers. The gel saddle helps to reduce road shocks while the Panaracer Smokes are your assurance of unparalleled traction.

SASQUATCH





PINNACLE Potent!

Unique chro-moly main triangle with tapered oval tubes for increased lateral and fore/aft rigidity. The oversize headset increases bearing life by spreading the load over more balls and a larger surface area. Exage 400 21-speed Rapid Fire equipped for crisp responsive Hyperglide shifts. Complete with a deluxe SR "TCO" seatpost, comfortable gel saddle, tough Araya VP-20 alloy rims, and deluxe stainless spokes with quick release hubs.

PINNACLE

BIGFOOT



BIGFOOT
A bold performer

The all new Bigfoot boasts a Tange chromoly main triangle with rigid oversized tubular rear-stay. Equipped with Shimano crisp shifting 21-speed Hyperglide Exage 30 components. Adorned with a comfortable gel saddle and beefy SR "TCO" seatpost. Note the tough Araya VP-20 rims, aggressive skinwall tires, powerful cantilever brakes, and quick release front wheel for added convenience.



KOKANEE

Rugged chro-moly main triangle

1991 brings dramatic improvements to the Kokanee including: a Tange chro-moly main triangle, new fast back style seatstays, super stiff oversized chainstays and a long radius tubular fork. Open cable guides on the top-tube reduce brake casing compression and increase response. Shimano 200 21-speed Rapid Fire Hyperglide equipped. Durable Araya MP-22 rims. Available in four sizes and an array of hot new colours.

K O K A N E E

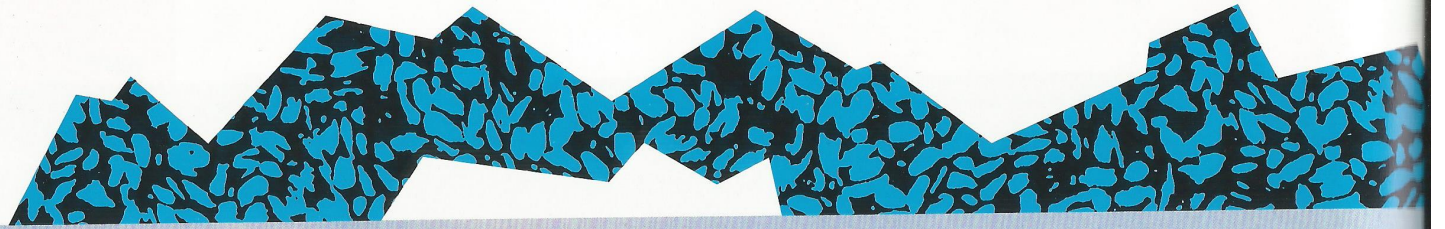

BUSH PILOTS



BUSH PILOT Captivating!

The 1991 Bush Pilot incorporates an oversized chromoly down-tube for increased strength and rigidity. Also new is the Shimano 200 21-speed rapid fire shifters, and inboard mounted rear U-brake on the smaller sizes for outstanding heel clearance. Additional key features include, light-weight Araya MP-22 alloy rims, flat racing style handlebar, quick release front wheel, and a rigid rear mono-stay.



KATMANDU Shimano rapid fire equipped

A new face in the Norco line. The Katmandu features include: a durable mountain frame and fork with added strength from chromo-moly down-tube, long radius uncrown forks, comfortable anatomical saddle, and durable Araya MP-22 alloy rims. Shimano has introduced rapid fire 21-speed shifting at a more economical price and Norco is pleased to offer this component group on the Katmandu. Available in four popular sizes.

KATMANDU

Reliable his and hers mountain bikes available in a wide selection of sizes and colours. Key features include: quality Sugino triple cranks, wide ratio 21-speed Shimano SIS gearing to flatten out the hills, smooth functioning Chang Star cantilever brakes, lightweight alloy rims, and a comfortable anatomic saddle. Check one out soon!



MOUNTAINEER
Comfortable
mid-rise riding
position

A popular economical bicycle complete with Shimano 18-speed Hyperglide gearing. Reliable Chang Star cantilever brakes with open top-tube cable for reduced casing compression and increased stopping response. Sealed mechanism hubs for increased bearing life, durable chrome plated rims and long wearing gumwall tires.

MOUNTAINEER



CHEROKEE
Value packed
enjoyment for the
whole family

Quality mountain style bicycles available in Mens, Ladies, Boys, and Girls models. All bikes feature Shimano Hyperglide gearing (Adults are 12-speed, children's are 6-speed). Quality, reliable side-pull brakes, comfortable mid-rise handle-bars, long wearing gumwall tires, and comfortable padded saddles.

CHEROKEE

JAMMER

A breakthrough
in Junior bicycle
performance

Popular sloping top-tube junior mountain design with a deluxe rigid rear mono-stay. Norco is pleased to offer the Jammer in a girls model for the first time. These quality units share the following features: 18-speed Shimano Hyperglide gearing, lightweight Araya alloy rims, deluxe reliable smooth functioning Chang

JAMMER

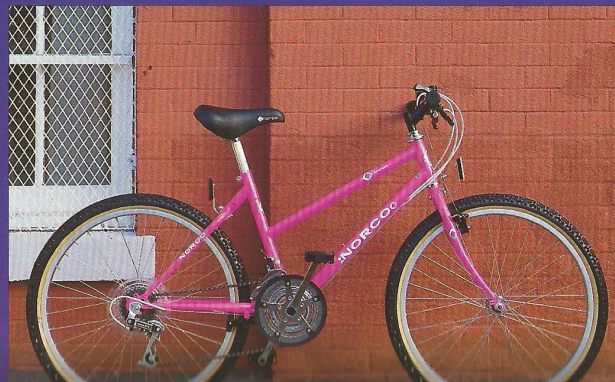

**dependable
excitement!**

Our best selling junior bicycles feature hot new paint jobs and exciting new graphics. Shimano 12-speed Hyperglide equipped to help cover all types of terrain. The powerful Chang Star rear U-brake and front cantilevers utilize levers with reach adjusters for a custom fit to smaller hands. Also note the racing style handlebars and comfortable padded saddles!



**MICRO
MOUNTAINEER**

MICRO MOUNTAINEER
They look small
but they're
big on fun!

Durable Micro Mountain frames with lots of stand-over height for the younger mountain bike enthusiasts. Easy shifting Shimano 6-speed Hyperglide gearing. Reliable sidepull brakes with deluxe reach adjustable brake levers, long lasting gumwall tires and sturdy chrome plated mountain rims. See them soon at a Norco dealer near you.

TIER RA



TIERRA

Leave the traffic
jam behind

Top quality chromoly main triangle with tough chromoly unicrown fork, reinforced seat collar and rigid oversized rear stays. Dependable Suntour XCF 21-speed X-press below-bar shifting, with deluxe alloy crankset. Powerful low-profile Suntour cantilever brakes, Araya PX-45 hybrid rims, versatile Panaracer "38 Special" tires and comfortable gel saddle complete this value-packed unit.

ARCTIC

ARCTIC Tailored to your needs

Mid-priced deluxe hybrid with chro-moly main triangle. Note the comfortable rise from the alloy stem, easy shifting Shimano 200 rapid fire 21-speed, Hyperglide gearing, rugged uncrown fork, and the quick release front wheel for added convenience. Durable Araya alloy 700C rims and high volume skinwall tires provide a smooth comfortable ride.



QUEST

QUEST Hassle free versatility

Economical his and hers mountain-lite style bicycles. Durable fully lugged frames with deluxe uncrown forks and open top-tube cable routing. The hi-rise stems with flat racing style bar provide a comfortable controlled riding position. Additional key features include: 18-speed Shimano Hyperglide gearing, reliable

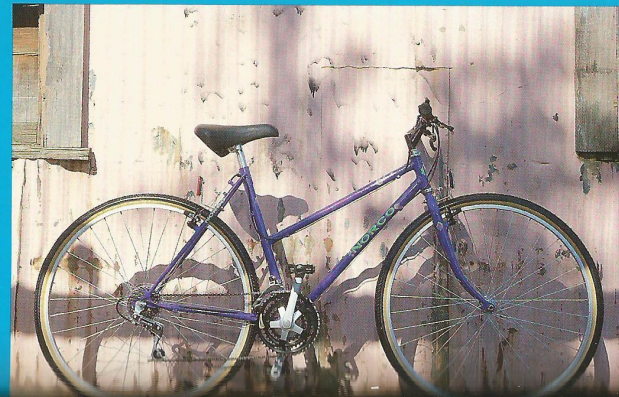

EUROSPORT
Lean, mean
racing machine

Light-weight full chro-moly racing frame with a rigid Mangaloy fork. Available in a five size breakdown to come close to a custom fit. Positive shifting Shimano Exage 500 14-speed Hyperglide gearing with Bio-pace front cranks. Ultra powerful dual pivot SLR brake calipers with sleek Aero levers and deluxe Criterium bend bars. Tough Araya SS-45 alloy rims.



EUROSPORT

VICTORY

VICTORY
Lively response

This spunky entry level racing bicycle takes advantage of the crisp shifting Shimano Exage 400 14-speed Hyperglide gearing and SLR Aero brakes. Comes complete with lightweight Araya SS-45 alloy rims, low profile racing pedals complete with clips and straps, sleek Vetta Mundial racing

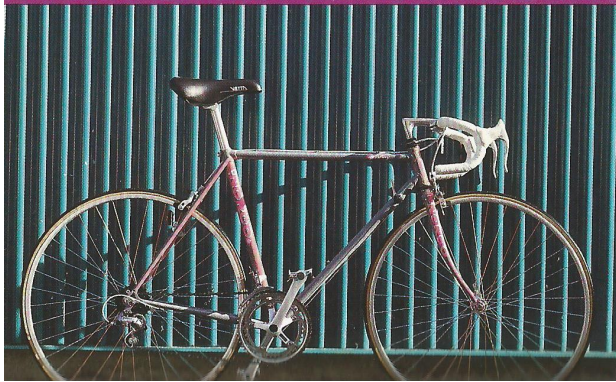

MONTEREY SL

MONTEREY SL
Affordable
performance
crafted in Japan

Economical recreation racing bicycle with durable Ishiwata chromo main frame. Suntour 14-speed Accushift index equipped. Durable Araya alloy rims with quick release hubs and long lasting Panaracer Dual tires. Responsive blaze side-pivot brakes with Aero levers and quick release for ease



SPECIFICATIONS	RAMPAGE PRESTIGE	MAGNUM L/A	SASQUATCH	PINNACLE	BIGFOOT	KOKANEE
FRAME SIZES	17", 18.5", 20"	15.5", 17.5", 19.5"	17", 18.5", 20.5"	16", 18", 20", 22"	16", 18", 20", 22"	16", 18", 20", 22"
FRAME	73 mm B.B. Shell. Tange Prestige oversized ATB 3-main tubes. Sloping top-tube, outer butted reinforced seat collar.	Full heat treated Tig welded aluminium T-7000 supersized 44 mm down-tube.	Tange Infinity double butted chro-moly Tig. welded. Sloping top-tube design with new 73 mm B.B. shell.	Tange double butted chro-moly "Max Style" ovalized tapered top, down-tube o-butted s-tube, lathe cut head-tube.	Tange chro-moly "Max Style" ovalized tapered top/down-tube, outer butted seat-tube.	Tange oversized chro-moly (3 main tubes) outer butted seat-tube, cut head-tube.
REAR STAYS	Tange full chro-moly. Fast Back style.	All light aluminum box section oversized.	Tange chro-moly with forged vertical ends.	Supersized tapered chainstay.	Supersized tapered chainstay.	Tubular (Fastback style).
FORK	Tange Prestige Switchblade 1-1/8".	Chro-moly supersized tubular 1-1/4".	Tange full chro-moly with long radius.	1-1/8" tubular chro-moly.	Full chro-moly tubular 1-1/8".	1" Hi-tensile tubular.
HEADSET	Shimano Deore XT. 1-1/8.	Shimano Deore XT supersized 1-1/4". Black.	Tange sealed mech. Black.	YST sealed mech. Black.	Sealed mech. Black.	Deluxe ATB. Black.
HANDLEBARS	Strong double butted L/A. Black bar.	Flat chro-moly bar in black finish.	Kusuki tapered flat bar. Chro-moly.	Flat chro-moly bar, tapered centre.	Flat racing bar.	Flat racing bar.
STEM	Tioga T-Bone full chro-moly. Internal cable routing.	Chro-moly Tioga style 105/135 mm top cable routing.	Chro-moly left side internal cable routing.	Full chro-moly Tioga style sloping top cap, side cable routing.	Full chro-moly tapered with drill hole.	Full chro-moly drill hole type.
TAPE/GRIPS	Tioga Bio Grips.	Tioga "Bio Grips".	Tioga "Bio-Grips".	Axiom Power Grip w/hard end plug	Axiom Ergo Krayton.	Axiom "Ergo" Krayton.
SADDLE	Vetta Gel Turbo racing.	Vetta mundial vinyl.	Anatomic ATB Gel VL 169-LG.	Norco Gel ATB.	Norco Gel ATB.	Vetta anatomic vinyl.
SEAT POST	Deore XT Prestige chro-moly.	Kalloy oversized light aluminium.	SR "Tall Cool One" Sport.	SR "Tall Cool One" oversized. Black.	SR "Tall Cool One. Black.	"The Post" 4130 chro-moly.
SHIFT LEVERS	Shimano Deore XT 7-speed SIS STI M092. Rapid Fire.	Shimano Deore DX STI 2-finger. STI-M070. Rapid Fire.	Suntour XC LTD Command 7-speed. Underbar.	Shimano Exage 500 STI 7-speed. Rapid Fire.	Shimano 500 LX STI 7-speed. Rapid Fire.	Shimano M020 7-speed Rapid Fire STI.
FRONT DERAILLEUR	Shimano Deore XT.	Shimano Deore DX.	Suntour XC LTD.	Shimano Exage 400 LX.	Shimano 300 LX.	Shimano 201 GS.
REAR DERAILLEUR	Shimano Deore XT 7-speed SIS. Direct mount type.	Shimano Deore DX 7-speed. Direct mount type.	Suntour XC LTD 7-speed. Direct mount type.	Shimano Exage 400 LX. 7 speed.. Direct mount type.	Shimano 300 LX. 7-speed. Direct mount type.	Shimano 200 GS.
FREEWHEEL	Shimano Deore XT 13-28T 7-speed Hyperglide cassette.	Shimano Deore DX 7-speed cassette 12-28T.	Suntour XC LTD 13-30T 7-speed cassette.	Shimano 7-spd 13-30T Hyperglide cassette.	Shimano 7-spd. 13-30T Hyperglide cassette.	Shimano 13-30T csst. Hyperglide.
CRANK SET	Full Deore XT with 26-36-46T Round rings. 170 mm or 175 mm. Superglide spacing.	Shimano Deore DX with 46-36-24T. Round Superglide 175 mm. Superglide spacing.	Suntour XC LTD 24-36-46T Black. Light-alloy cranks. Sealed mechanism B.B.	Shimano Exage 400 LX light alloy 28-36-48T Black Bio-Pace. Superglide rings.	Shimano Exage 300 LX light alloy. 170 or 175 mm 28-38-48T. Black. Superglide Bio-Pace.	Shimano Exage 200. 28-38-48T Bio-Pace Superglide. 175 mm with coated black rings.
BRAKE CALIPERS	Shimano Deore XT Low Profile cantilevers front and rear. Stainless tube cable routing.	Shimano Deore DX new Low Profile cantilevers.	Suntour CT-XLOO Low Profile cantilever front and rear.	Shimano 500 LX front cantilevers rear U-brake on small sizes.	Shimano 300 front cantis. Rear 300 canti Low Profile.	Shimano Exage 200 front cantis. M352 U-brake seatstay mount small sizes.
BRAKE LEVERS	New ST-M092 with fast cable "pick-up" cam design.	Shimano Deore DX 2-finger combo. Oversized cable. 2.0 x 6.0 mm SLR.	Suntour XCD mountain levers. Combo type "BRS" lined cables.	Shimano 500 LX STI combo full length levers. Oversized cables.	Exage 500 LX full length combo type. Oversize cables 2.0 mm.	Shimano 200 mountain levers SLR cables.
PEDALS	Shimano Deore XT Low Profile comp. with clips.	Shimano Deore DX Low Profile comp. with clips.	MKS alloy body steel cage with clips and straps.	MKS light alloy body.	Plastic mountain. Pedals with reflectors.	Plastic mountain pedals with reflectors.
CHAIN	Shimano Deore XT narrow. Hyperglide.	Shimano Hyperglide narrow.	Suntour XCD narrow index.	1/2 x 3/32" Hyperglide. Made in Japan.	1/2 x 3/32" Hyperglide. Made in Japan.	1/2" x 3/32" Hyperglide. Made in Japan.
HUBS	Deore XT quick release hub set. 7-spd cassette rear. 32 hole.	Shimano Deore DX quick release light alloy. 7-speed cassette rear.	Suntour XCD light alloy sealed mechanism. Rear 7-speed cassette.	Shimano Exage 500 light alloy. Both are quick release.	Shimano 300 LX light alloy. Rear 7-speed cassette.	Shimano light alloy. Front quick release. Rear 7-speed cassette.
SPOKES	Asahi 14-15G double butted stainless.	14G stainless with brass nipples.	Asahi stainless 14G with brass nipples.	14G stainless with brass nipples.	14G with brass nipples.	14G with brass nipples.
RIMS	Araya RM-17 super hard anodized.	Araya #CV-7 black anodized.	Araya #CV-7 Black anodized, L/A.	Araya VP-20 light alloy anodized.	Araya VP-20 light alloy anodized.	Araya MP-22 light alloy anodized.
TIRES	Panaracer "Smoke" 26 x 2.1". Black skinwall.	Tioga Mud Dawg 26 x 1.95". Skinwall.	Panaracer 26 x 1.0 "Smoke". Black skinwall.	26 x 2.1 skinwall on/off mtn. tires.	26 x 2.0. Skinwall on/off mtn. tires.	26 x 1.90 on/off skinwall mountain tires.
WEIGHT	27-1/2 lbs.	28 lbs.	28-1/2 lbs.	30 lbs.	31.5 lbs.	32 lbs.
COLOUR	Shiny Black with Coral decals.	Pearl White with Black trim.	Matte Aztec Blue with Black 1/2 and 1/2. White/D.G. Yellow/Coral (3 tone fade).	Shiny Black w/Electric Blue trim, Violet w/DG Pink & Aqua splatter.	Elec Blu. w/Coral splat./White splash, Matte Plum/w Black trim, Shiny Black.	Matte Peacock Blue/Shiny Blue Shiny Blk. Neon Yel w/Coral splat. Electric Blue splatter.