

SUNTOUR BICYCLE EQUIPMENT CATALOG 1990

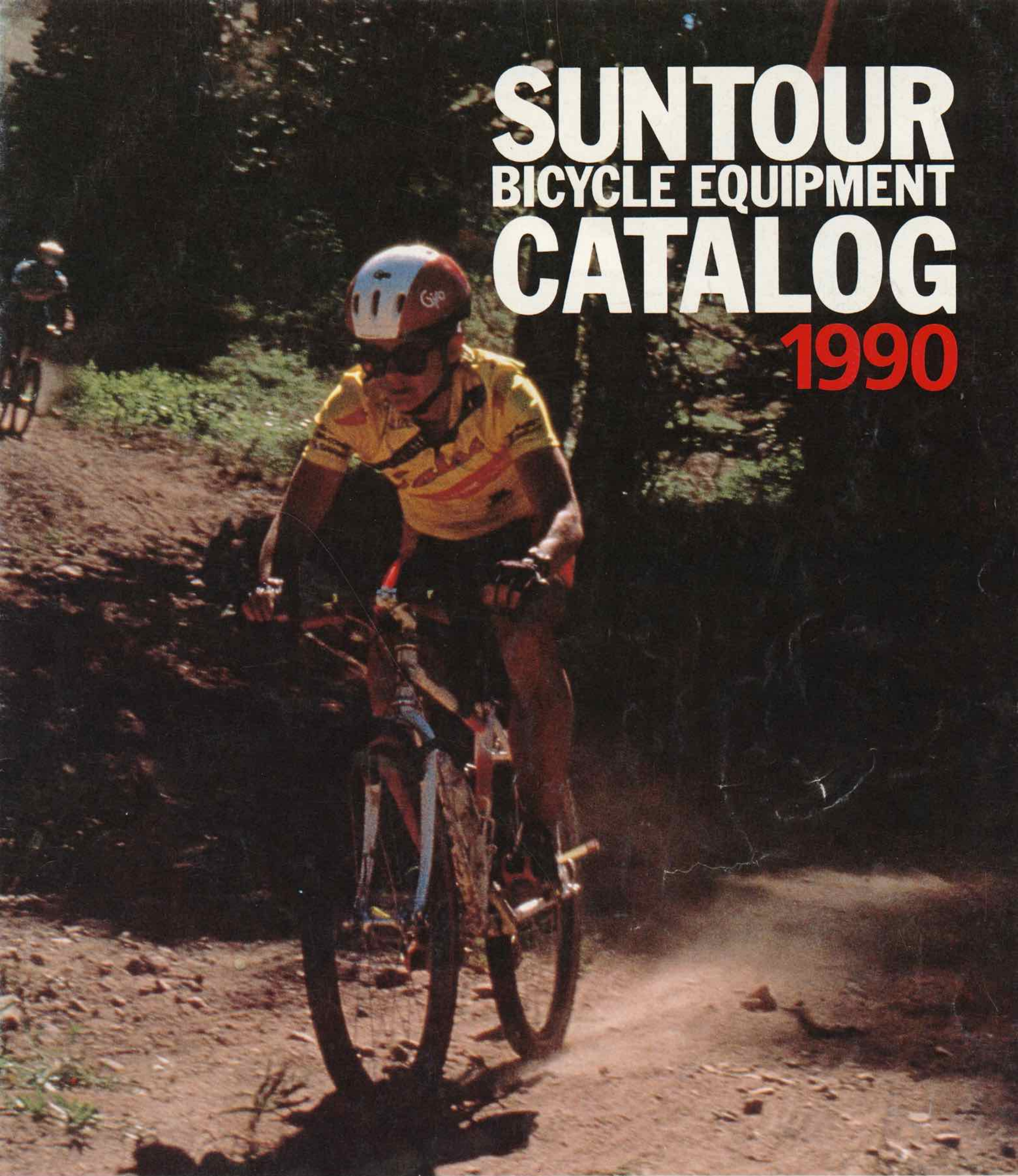

ENGLISH
LANGUAGE
VERSION

 **SUNTOUR**



SUNTOUR, NO DOUBT!

Some component manufacturers would have you believe that THEY know more than you do, about what YOU want to ride. We believe in listening, not lecturing, which is how our SUNTOUR 1990 component line evolved.

RIDERS told us they didn't want hype; they wanted dependable, durable, light, responsive and affordable componentry that isn't obsolete before you get it out of the box. MECHANICS said components have to work BETTER in the field than in the stand, that new designs should be integrated into existing systems so parts are interchangeable, and that assembly and repair should be straightforward. FRAMEBUILDERS sat us down and demanded stuff that fits proven standard frame dimensions, existing standard tooling and sensible standard mounting bosses. DEALERS wanted all that plus availability, reliability and a commitment to service.

"Is that ALL?" we said. Actually, we have always been committed to making bike parts that make sense from the rider and mechanic perspective. Which is why ALL of our rear derailleurs have the same slant parallelogram geometry, and NONE of the new 1990 drive train components lock you in with dedicated specifics.

From the simplest cantilever brake to the electronic gear changing system of the BEAST, SUNTOUR for 1990 can be summed up in three words: LIGHTER, STRONGER AND SMOOTHER. We lost the most weight at the exciting XC-PRO, XC-COMP and XCD levels. Most parts are 15% - 40% lighter than last year, but stronger due to the use of more chrome-moly and cold-forging. Smoother shifting at each specific point in the gear changing process is realized by the combination of the AccuShift Plus freewheel/hub, chain and PowerRing Anti-Jam chainrings. The AccuShift Plus system incorporates the traditional shift levers or the hot, new, underbar, push-operated X-PRESS lever. Either way, your shifts are quick, easy and exact; whether jumping or dumping from cog to cog, or upshifting or downshifting from chainring to chainring.

SUNTOUR is proud of the engineering of our 1990 components; engineering which encourages you to tackle the road or dirt, ride hard, hammer down and have NO DOUBT that, because of SUNTOUR's single-track mind, your equipment will go the distance.

Lighter, Stronger, Smoother **ACCUSHIFT PLUS**

SUNTOUR ACCUSHIFT PLUS SYSTEM

THE ACCUSHIFT PLUS SYSTEM is the result of extensive reevaluation of all components of the drive train, in an effort to improve shifting performance at each specific point in the gear changing process. The specific improvements are as follows:

- * AccuShift Plus freewheel / freehub. All the cogs were analyzed to determine the precise point of contact with the chain during the gear change and have been completely redesigned with new gate cuts and profiles. Because the exact engagement of the chain doesn't depend on a specific point on the cog teeth, like other systems, smooth upshifting and downshifting is possible all the time, through mud, dirt or water. The normal wide range of gear ratios is available and the AccuShift Plus cogs are interchangeable with existing cassette and freewheel bodies.
- * AccuShift Plus chain. The outer link plates of the chain were sized down and beveled out for a better engagement of the cog teeth. In conjunction with removing the bushings and die-hardening the links, a weight reduction of 10% was realized. The chain is not only lighter and stronger, but shifts smoother and lasts longer.
- * PowerRing Anti-Jam Chainrings. The shape of the chainring teeth, in conjunction with the action of the front derailleur, plays an important part in the transfer of the chain from chainring to chainring. By reshaping the teeth at critical points, chain jamming has been eliminated and shifting performance has been dramatically improved.
- * The AccuShift Plus System incorporates the traditional shift lever or the new X-PRESS control lever. Either way, your shifts are quick, easy and exact; whether jumping or dumping from cog to cog or upshifting or downshifting from chainring to chainring.

X-PRESS

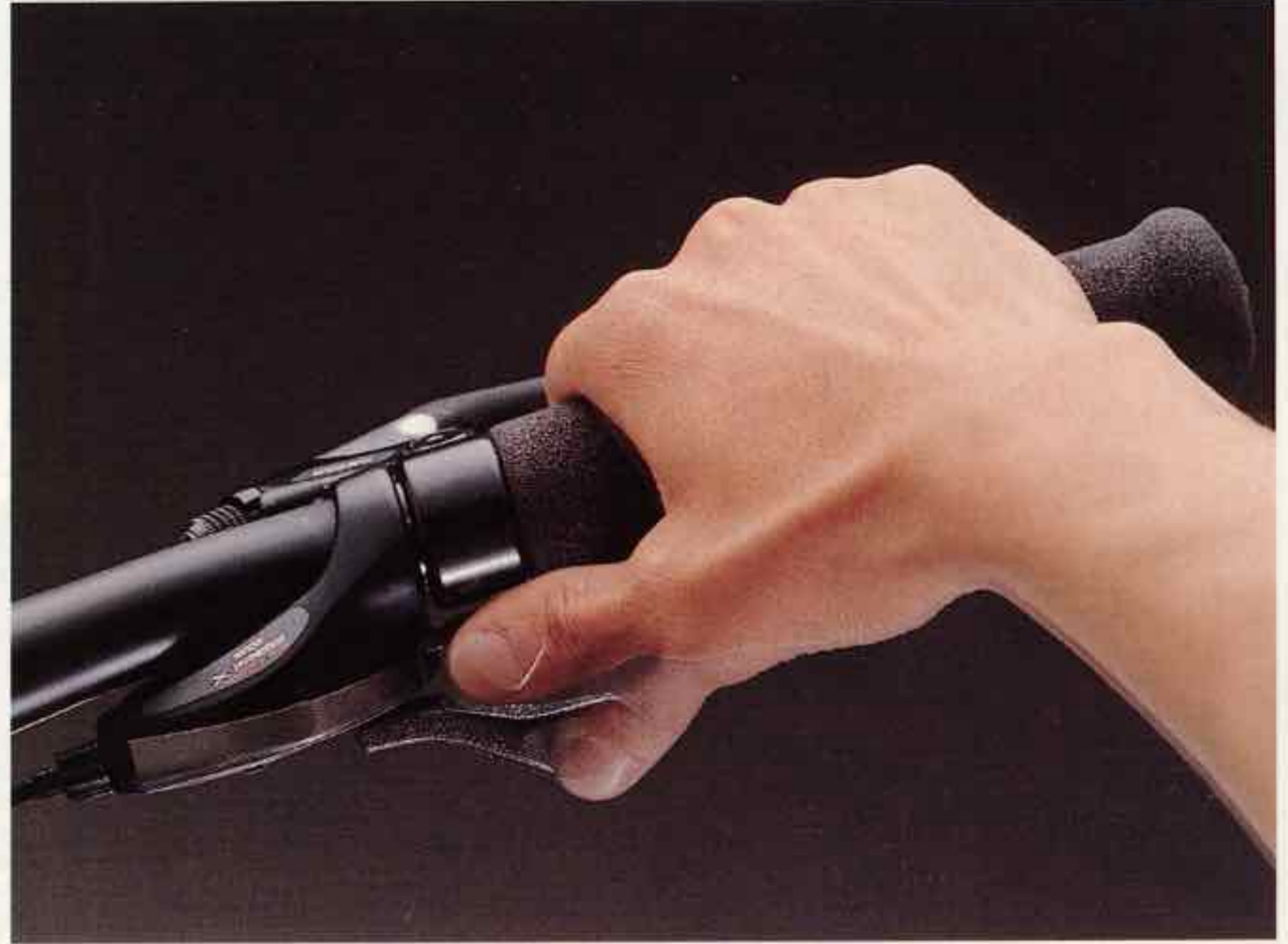

SUNTOUR X-PRESS CONTROL LEVER

Traditional shift levers on ATB bikes operate by pushing the lever forward to upshift and pulling the lever back, or towards you, to downshift. It is difficult to maintain control of the bar at high speeds or on long descents AND shift at the same time and nearly impossible to shift while braking. Until now. The X-PRESS lever is operated by a simple push with the thumb, whether shifting up or down, so all four fingers can maintain control of the handlebar and brake levers.

Two push levers are positioned on each side and under the handlebar. The top lever is pushed to upshift the rear derailleur and the lower lever is pushed to downshift the rear derailleur. On the left side of the handlebar, the top lever is pushed to drop the chain to a smaller chainring and the lower lever is pushed to throw the chain to a larger chainring.

The X-PRESS Control Lever is available with XC-PRO, XC-COMP, XCD, X-1/CHROMA, XCE, XCM and XCT ATB groups. X-PRESS Control Levers can be used with any SUNTOUR AccuShift compatible derailleurs.

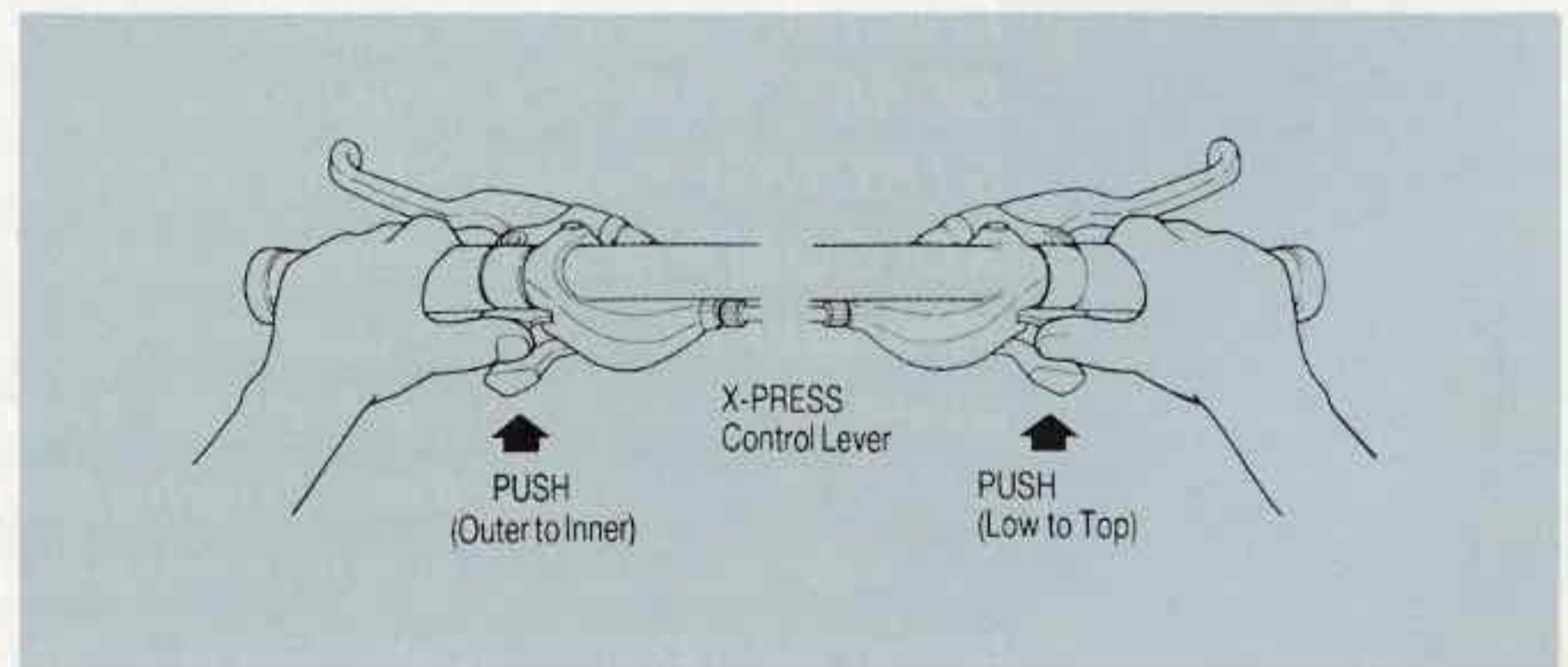

POWERING

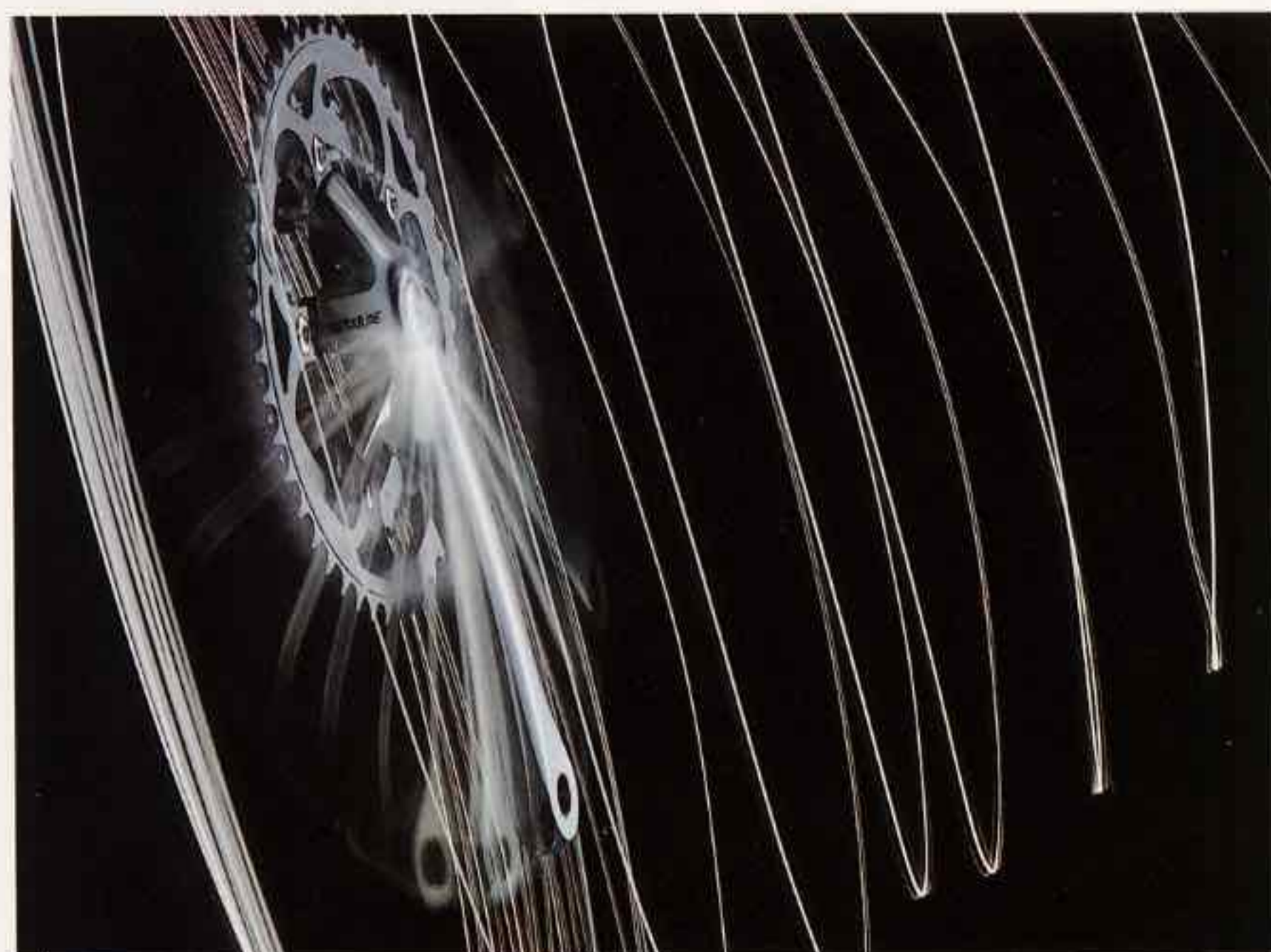

SUNTOUR POWERING

When attempting to drop the chain from the outer chainring to the middle chainring under load, the chain sometimes jams between the two chainrings. This can result in either bent chain links or a broken chain. Both of these mishaps impede forward progress of the rider and usually require him/her to get off the bike. If this happens in a race, precious seconds are lost.

SUNTOUR has redesigned the chainring tooth profile at the directional point of initial chain engagement, on the outer and middle chainrings. This Anti-Jam tooth shape also delivers smoother shifting when used with the AccuShift Plus Chain and Freewheel.

POWERING is standard on GPX, RADIUS, EDGE, and BLAZE for lightweight bikes and XC-PRO, XC-COMP, XCD, X-1/CHROMA, XCE, XCM and XCT for ATB bikes.

APCHAIN APCOGS

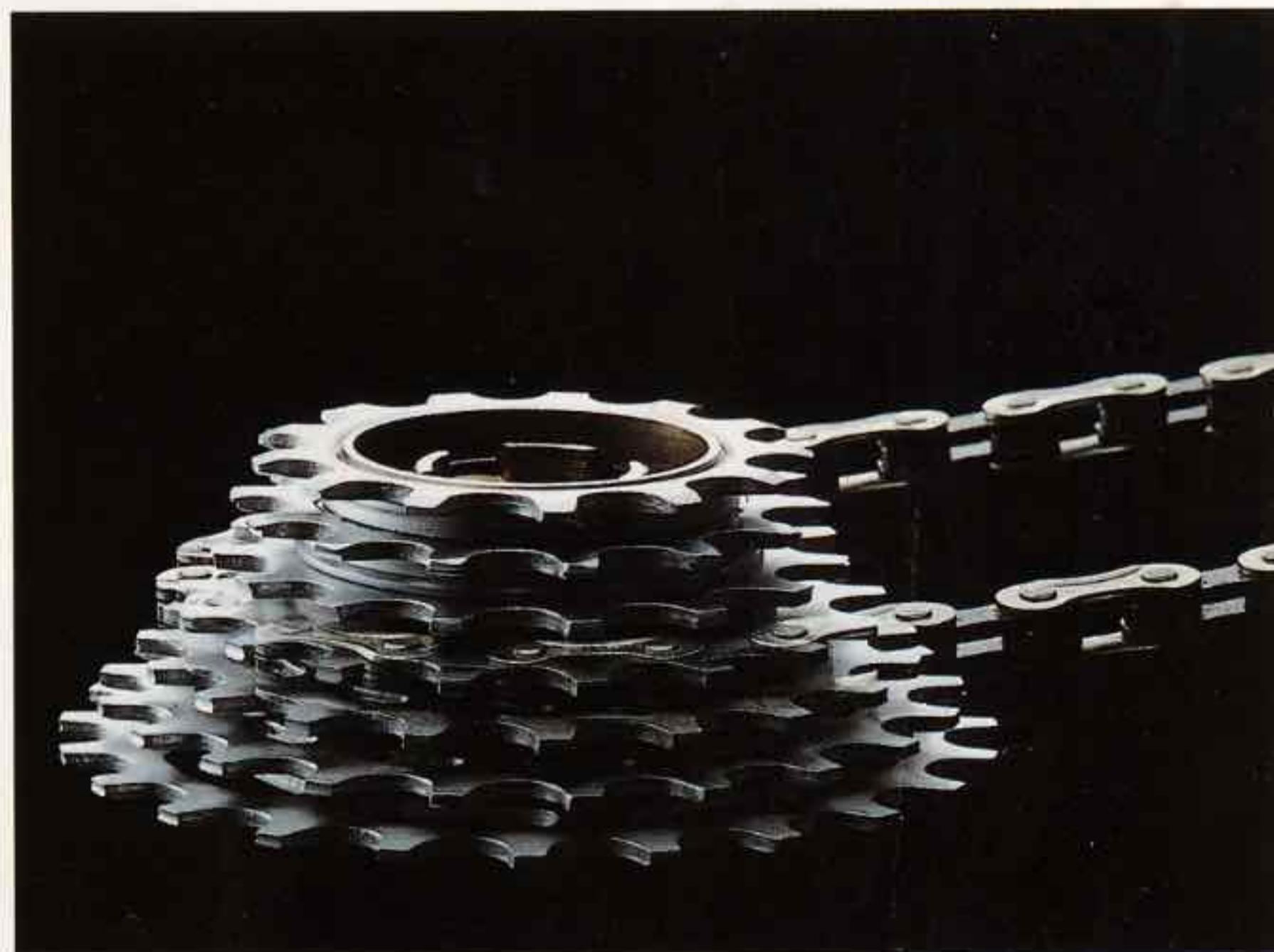

SUNTOUR ACCUSHIFT PLUS CHAIN AND COGS

The SUNTOUR AP-Chain and AP-Freewheel are designed to improve the accuracy of shifts under any road conditions, under any off-road conditions and, most importantly, under load when shifting not only to an adjacent cog but when skipping two or more cogs.

Improved performance is due to:

The beveling of the outer chain plates. A quick engagement of the cog is achieved by matching the cog tooth profile and the reshaped outer face of the chain link plates. Abrasion resistance and pedaling noise are decreased substantially by using a die-hardened and bushingless pin, which also reduced the weight of a 116 link chain by 10%.

All the cogs have been redesigned with new gate cuts and profiles. Because the exact engagement of the chain doesn't depend on a specific point on the cog teeth, like other systems, smooth upshifting and downshifting is possible all the time, through mud, dirt or water. The normal wide range of gear ratios is available and the AccuShift Plus cogs are interchangeable with existing cassette and freewheel bodies.

ACCUSHIFT PLUS Chain and Freewheel are standard on the entire SUNTOUR road and ATB line, except for AC1000 and ALLEGRO.

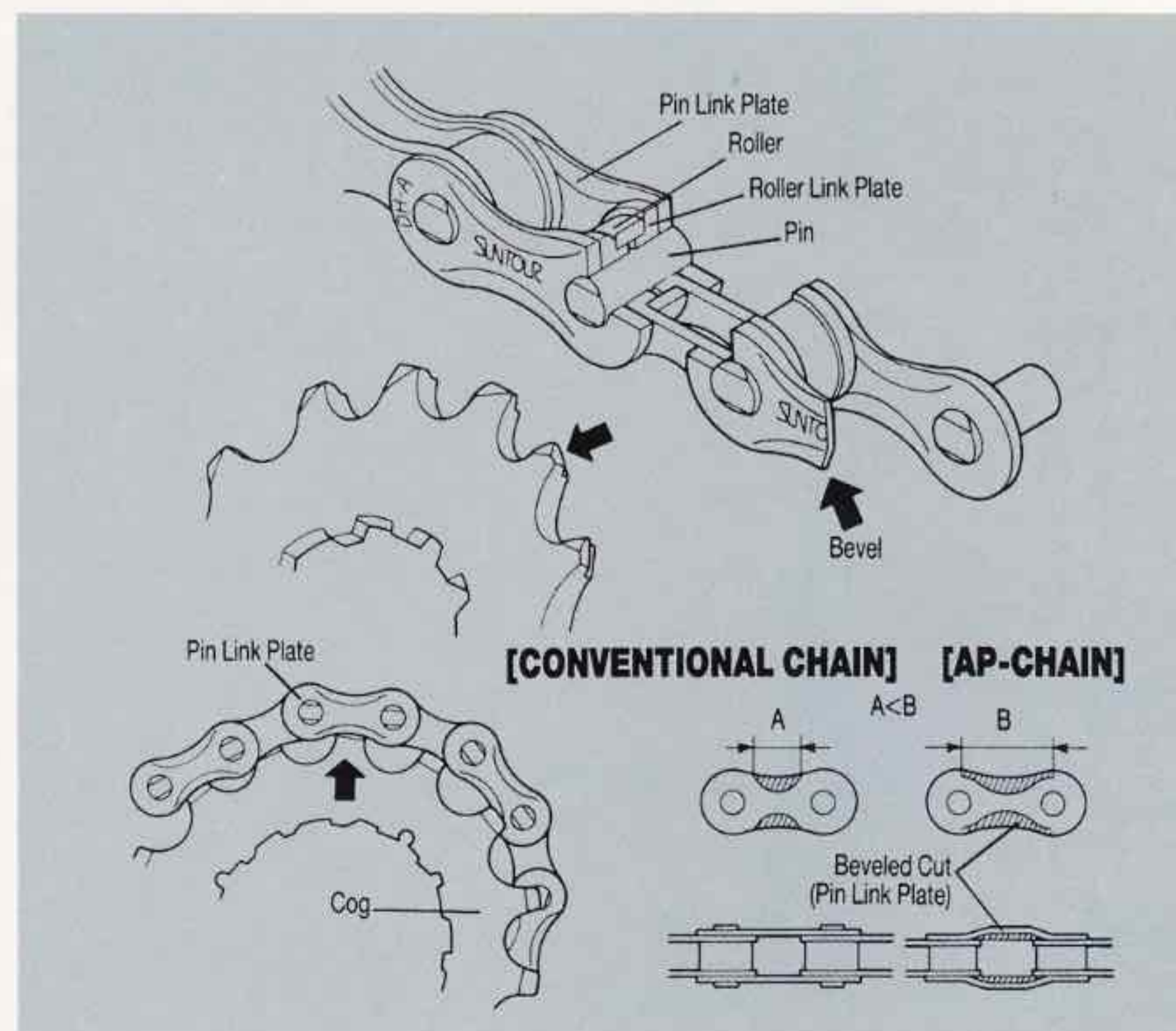
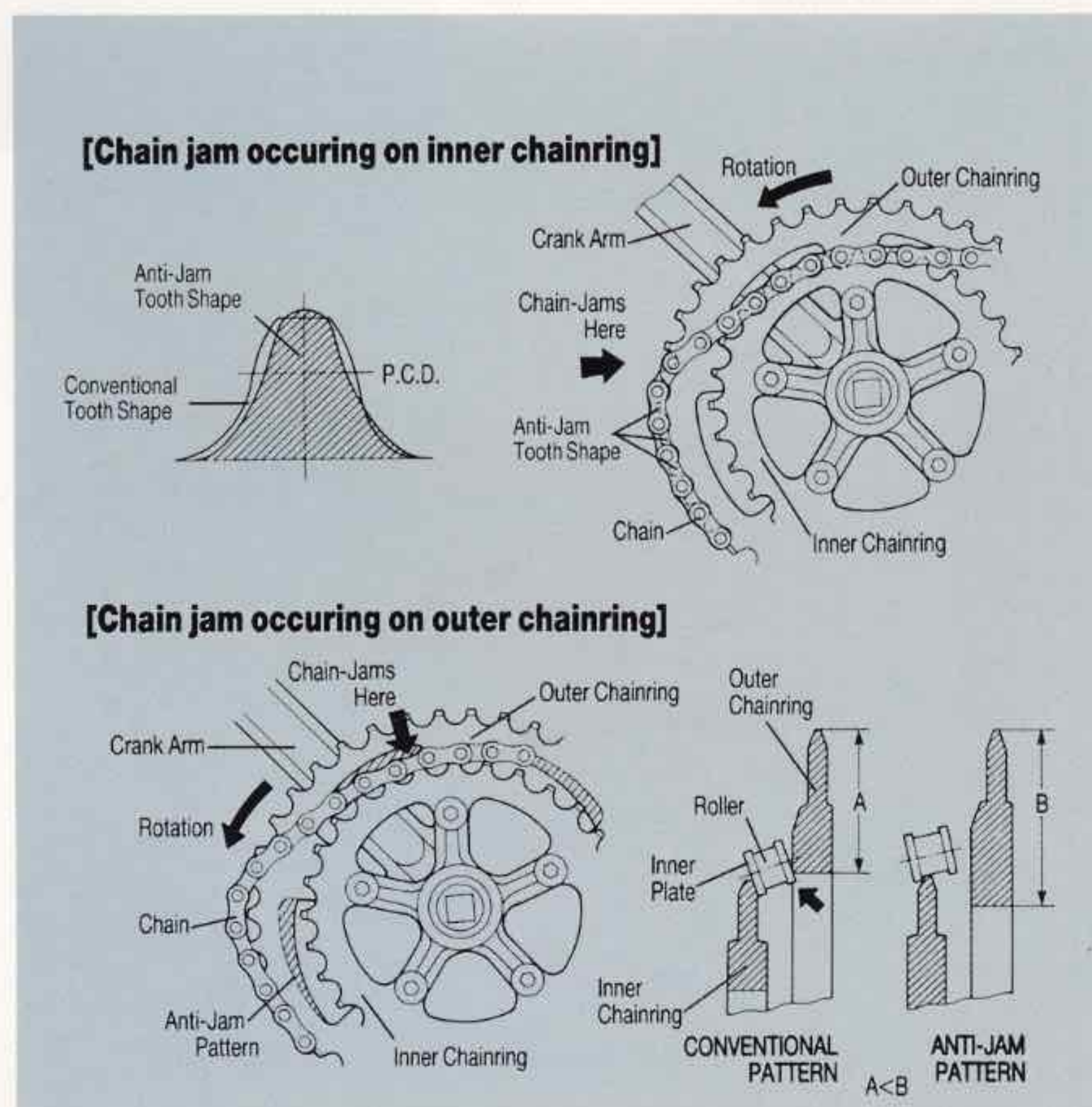

Lighter, Stronger, Smoother
ACCUSHIFT PLUS

COMMAND



SUNTOUR COMMAND SHIFTER

The SUNTOUR COMMAND SHIFTER is an entirely new shift lever concept for use on standard drop bars. It is mounted on the inside of the brake lever bracket for a more comfortable and accessible shifting motion. Like the original SUNTOUR BarCon shifters, it is not necessary to remove your hands from the bars to shift. Unlike the BarCon levers, however, the Command shifter is in a more convenient position and offers the option of either pushing or pulling the lever.

This new upshift and downshift dedicated lever is ideal for all light-weight bikes, from entry level to racing, and is perfect for hybrids, tandems and triathlon bikes. It is offered with the GPX, RADIUS, EDGE and BLAZE groups, and can be used with any SUNTOUR AccuShift compatible derailleurs.

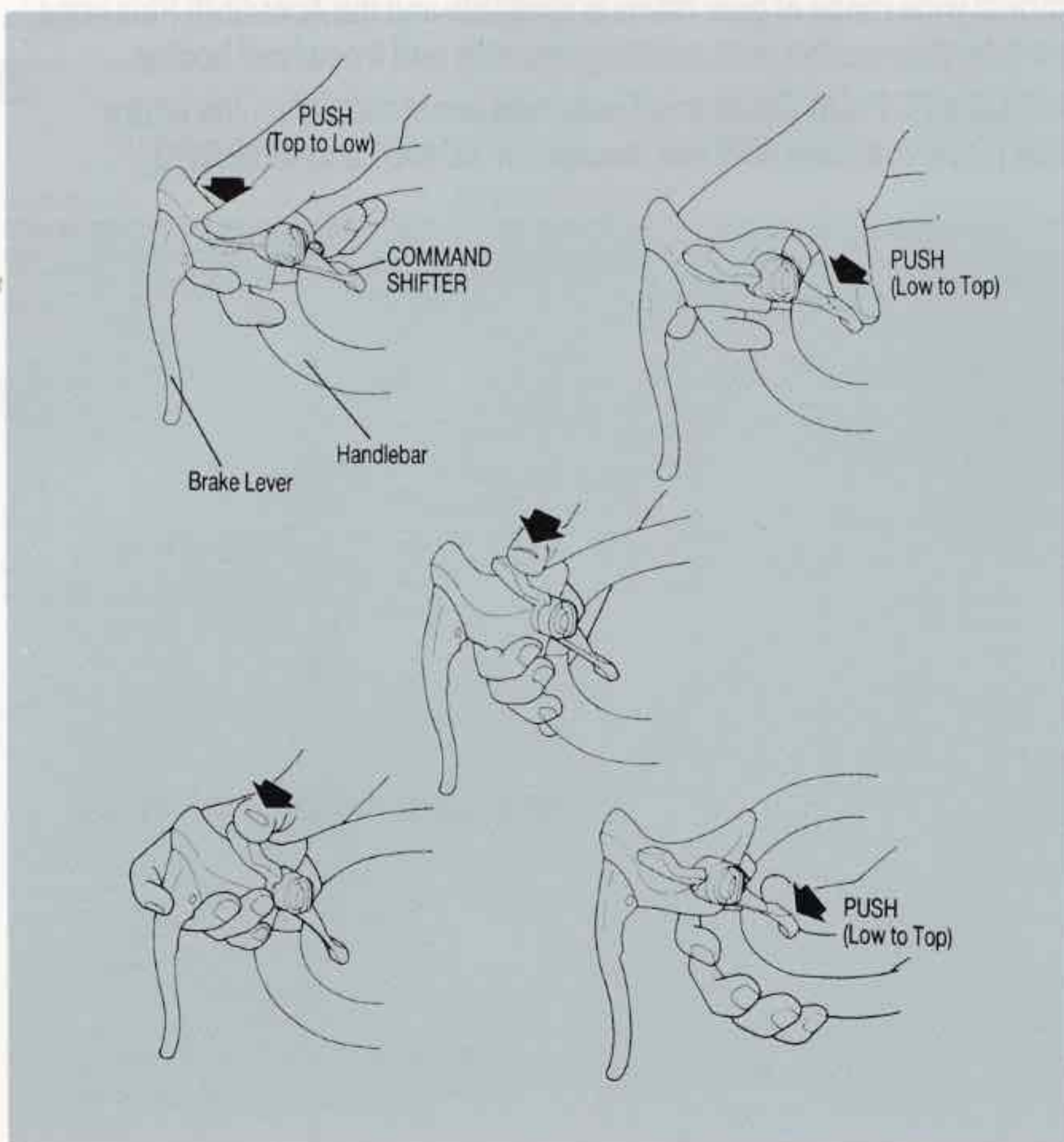

AP SHIFTER



SUNTOUR ACCUSHIFT PLUS INDEXING MECHANISM

In the event of damage to the rear derailleur, it is sometimes necessary to switch from full indexing mode to a shifting mode which allows the rider to trim the derailleur to compensate for misalignment caused by the damage.

For cyclists who have only used an index shifting system, the conventional on/off type index shift levers do not provide adequate gear selection guidance when in emergency "friction" mode.

The AccuShift Plus shift lever mechanism provides a guiding "click" even in its emergency mode, assuring that even the most inexperienced rider can find the right gear regardless of conditions.

The AccuShift Plus Indexing Mechanism is standard with the GPX, RADIUS, EDGE, BLAZE, VX and AC2000 groups, and with all SUNTOUR standard thumb shifters.

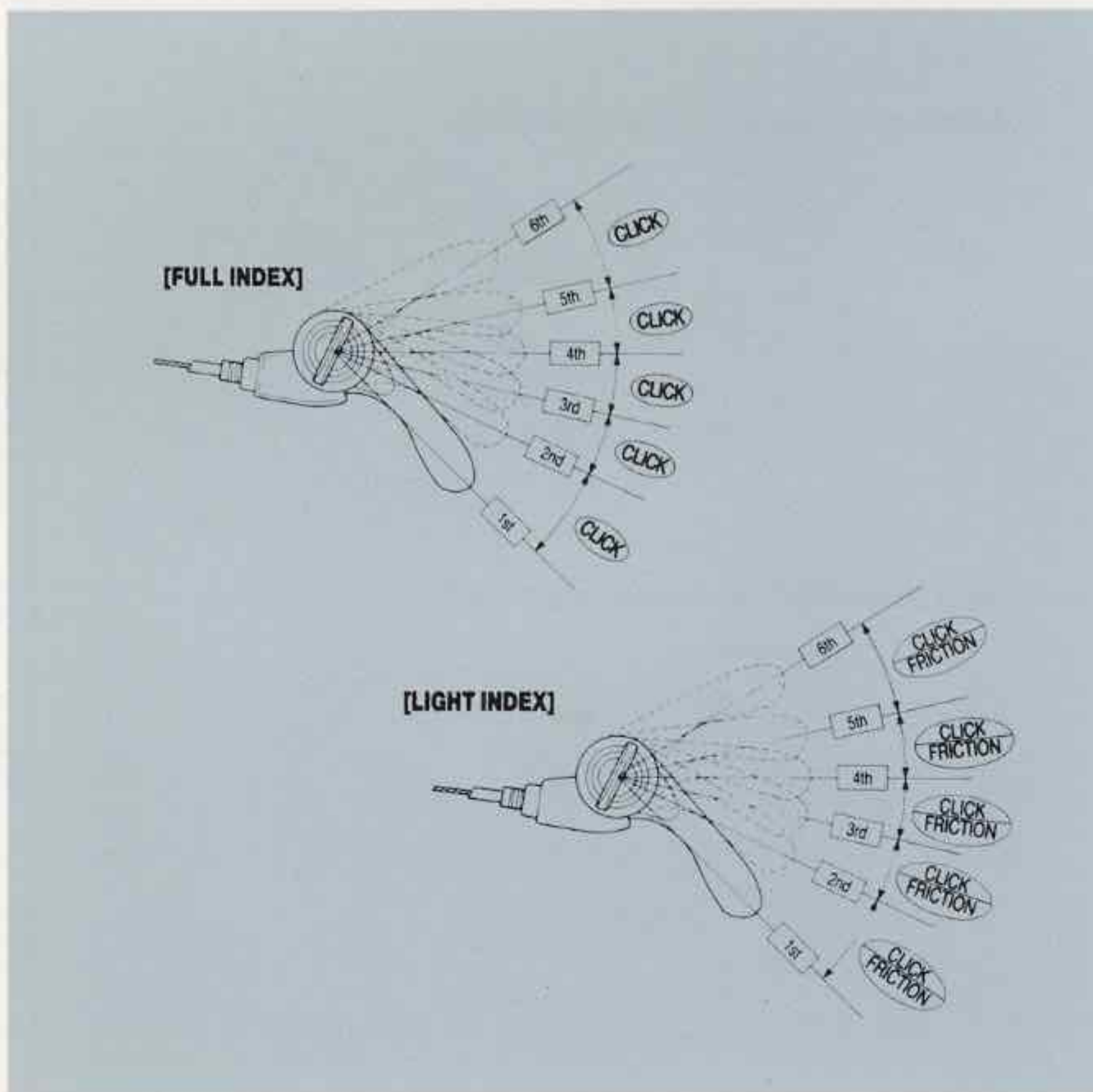

MULTI MOUNT



SUNTOUR MULTIMOUNT CONTROL SYSTEM

Handlebars on ATB bikes have evolved to their narrowest possible width, largely determined by existing brake and shift lever dimensions, width and fit of stem to the swaged/bulge section of the handlebar, and comparative positioning tolerances of the brake and shift lever clamps. Riders wanting the increased control of narrower bars have had to compromise by trimming clamps, levers and grips. With the MULTIMOUNT CONTROL SYSTEM, the discriminating rider can position the levers closer together, with more options. The new, compact shift levers allow for placement either inboard or outboard of the brake levers. But you're not limited to traditional thumb shifters with MULTIMOUNT. Our new X-PRESS Control Lever is designed to match the MULTIMOUNT system, clamp for clamp. Now you can shift: over-bar, under-bar, closer, farther, pushing upshift, pushing downshift, pushing and pulling upshift and downshift, big hands, small hands, no hands, braking/shifting, no shifting/braking, no braking/flying, no excuses, no position better than the one you like best. Combined with the brake levers, available in standard four-finger or compact two-finger size, this broad selection of control positions will provide a perfect fit with any spec handlebar or stem. In addition to the increased positioning options, the forged aluminum levers are lighter and stronger, easier to grab because of a dipped anti-slip coating, and safer and less fatiguing due to the handy reach adjuster and beefy return springs. MULTIMOUNT is available with XC-PRO, XC-COMP and XCD groups for 1990.

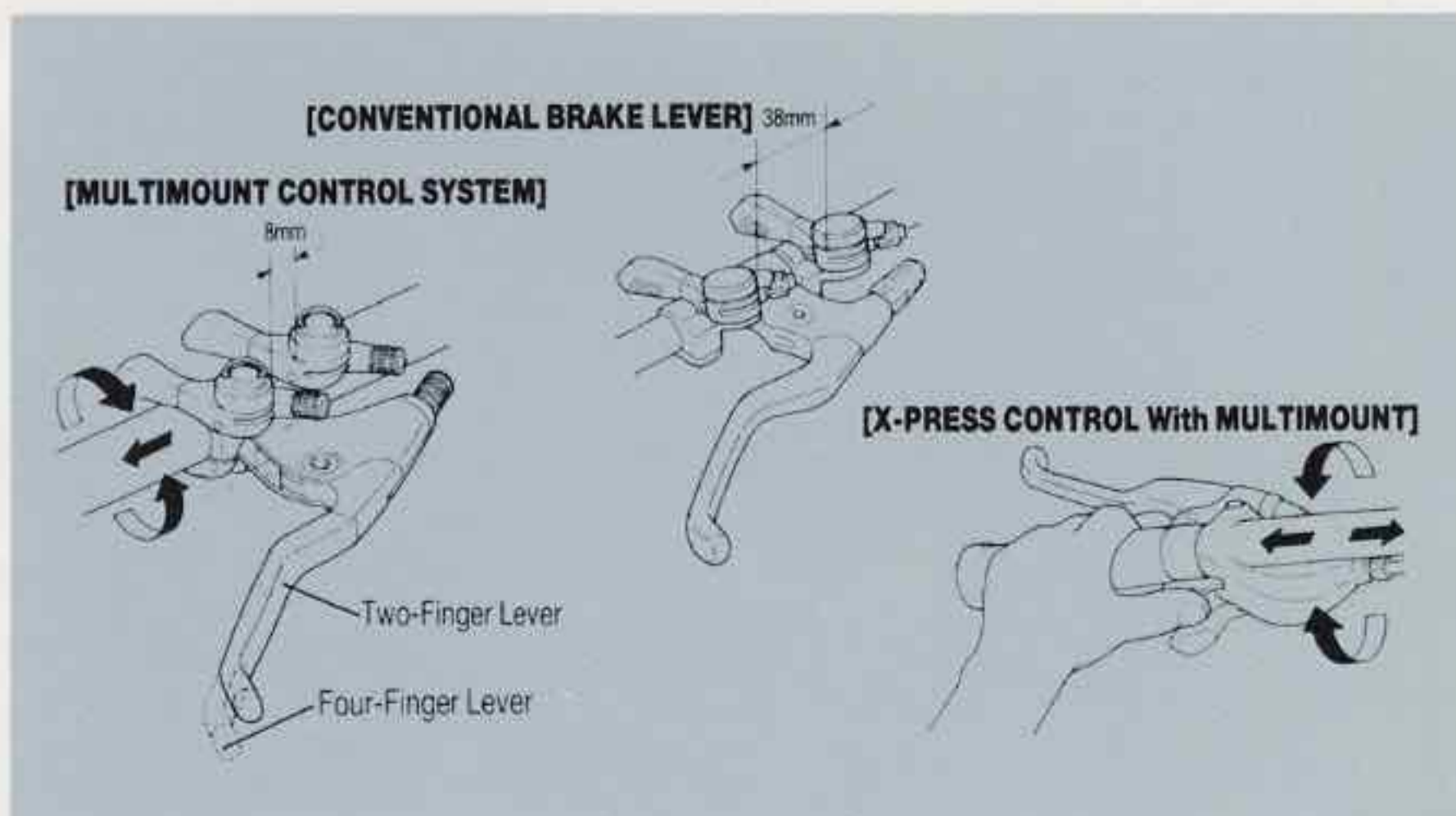

BEAST

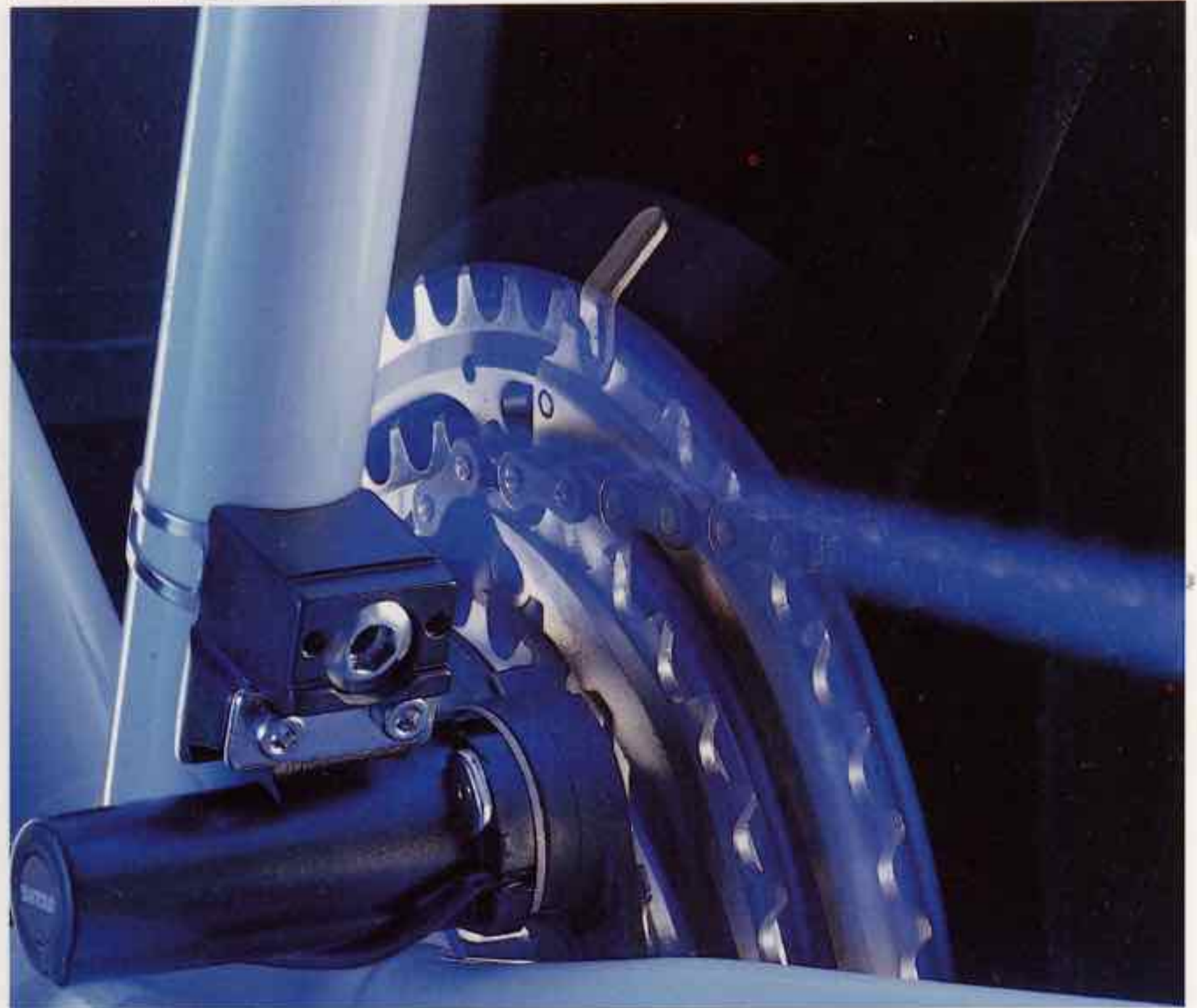

SUNTOUR BROWNING ELECTRONIC ACCUSHIFT TRANSMISSION (BEAST)

The SUNTOUR BEAST is an entirely new concept for changing gears on bicycles. The BEAST allows for precise gear changes while riding at high speed over varying terrain and grades. Perfect shifts are accomplished even with full power to the pedals, and since no special skill is necessary for smooth shifting, the BEAST is ideal for the difficult conditions of off-road riding.

The gear changing system of the BEAST is like the switching system of a railroad track: the outer and middle swinging sectors of the BEAST's chainrings function in the same way as the switch which allows a train to move from one track to another. At the hinged portion of the chainring, the pawl moves the swinging sector, which then picks up or drops the chain to the next chainring.

SUNTOUR has spent a full year testing and refining the original Browning technology before offering the BEAST as an alternative to the traditional front derailleur. The BEAST is compatible with all SUNTOUR drivetrain components. For 1990, it is offered as original equipment to bicycle manufacturers and custom builders only.

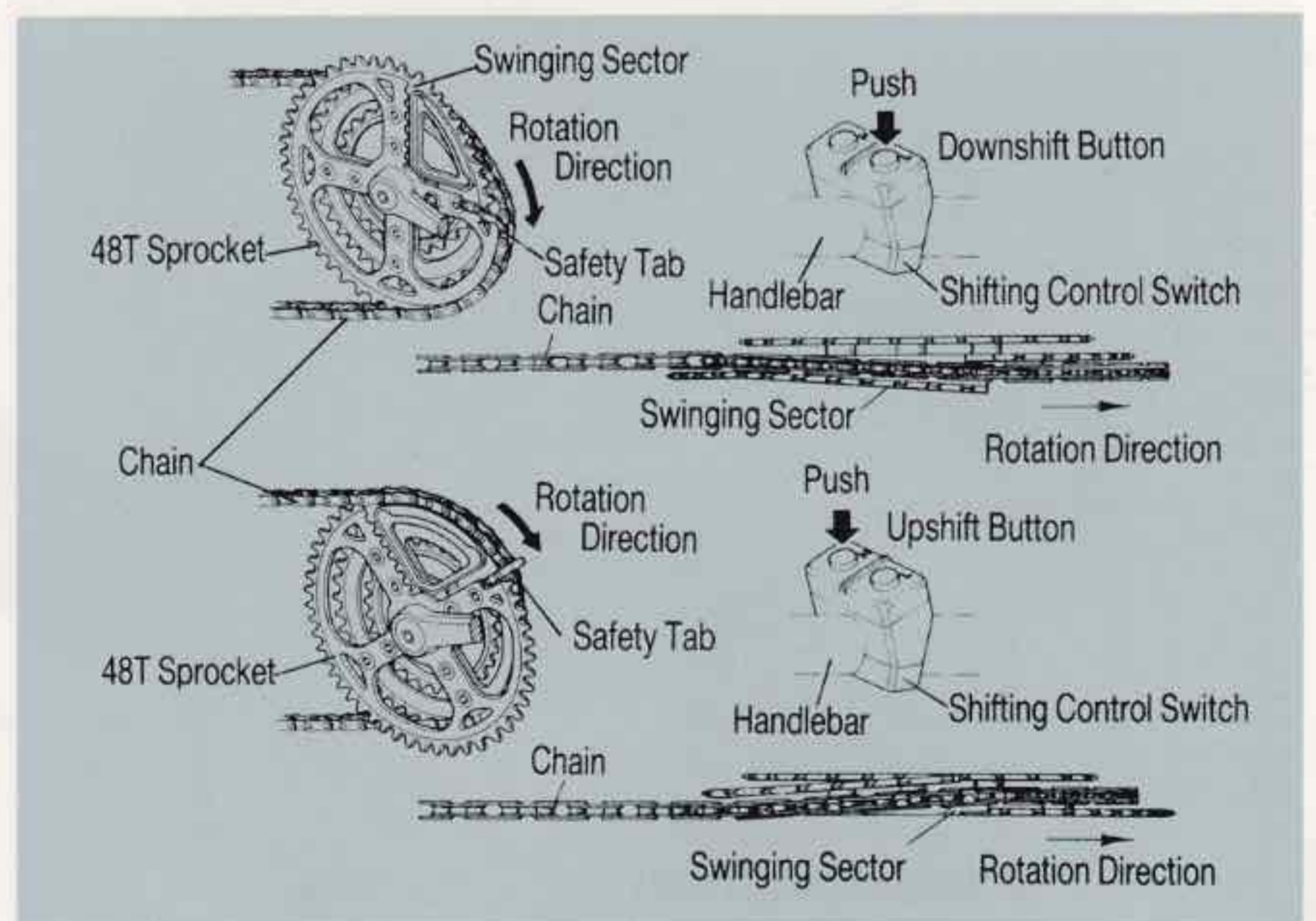

SUNTOUR SPECIAL FEATURES

SE

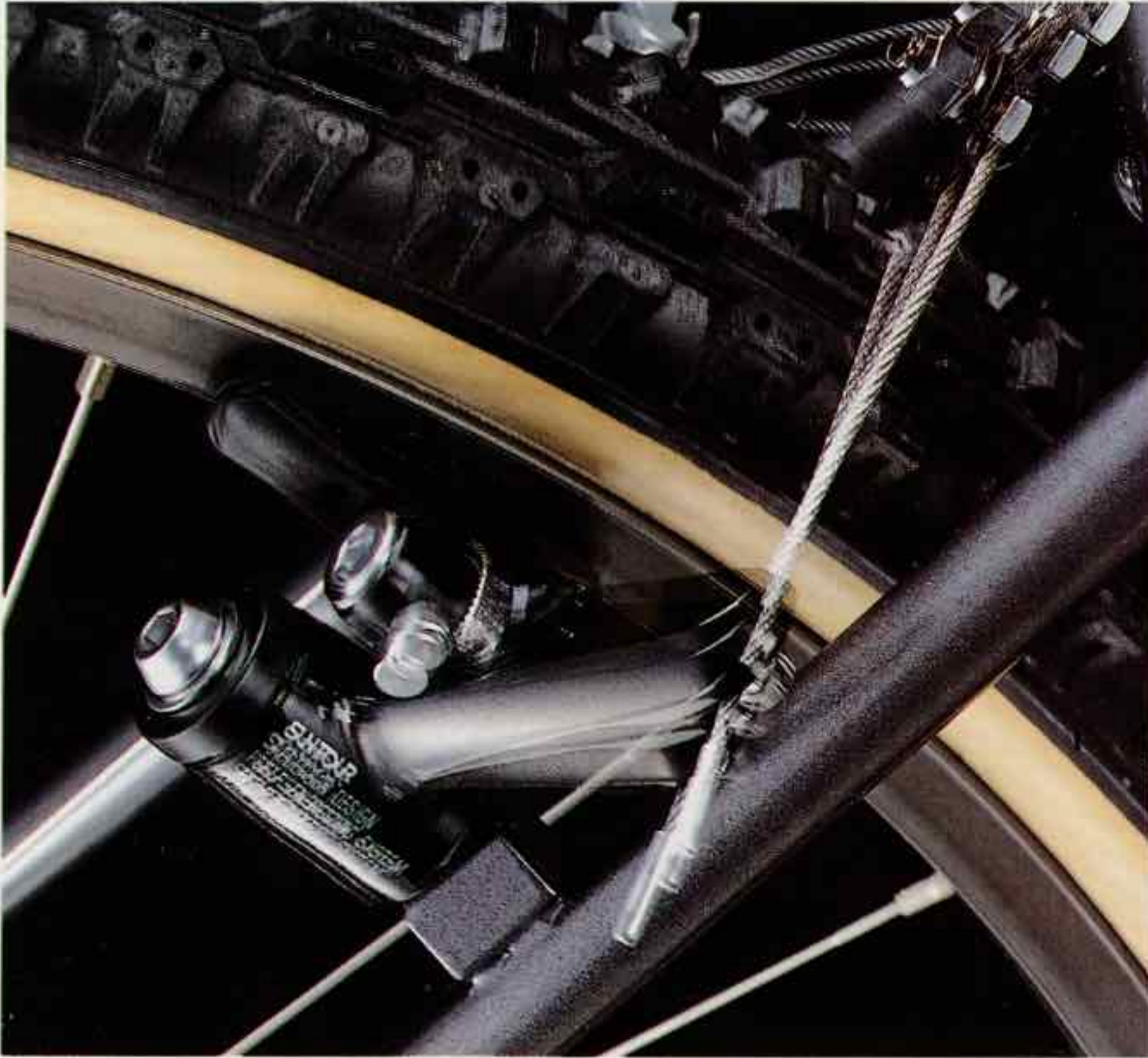

SUNTOUR SELF ENERGIZING BRAKE (SUNTOUR SE MECHANISM)

In order to increase the relative stopping power of a conventional cantilever brake, more force must be applied at the brake lever. This can be very fatiguing and ultimately dangerous on a long downhill. The SE brake delivers perfectly controlled braking power by utilizing the energy of the rim rotation and transferring it to braking force. This is achieved by a directional helical mechanism inside the brake arm. Other improvements to the original Pedersen design include a quick-release mechanism and adjustable, one-piece composite brake shoes. Because of the tremendous power generated when fully engaged, the SE brake is offered for rear use only. The SE brake is THE preferred brake for tandems. It is standard with the XC-PRO, XC-COMP and XCD groups.

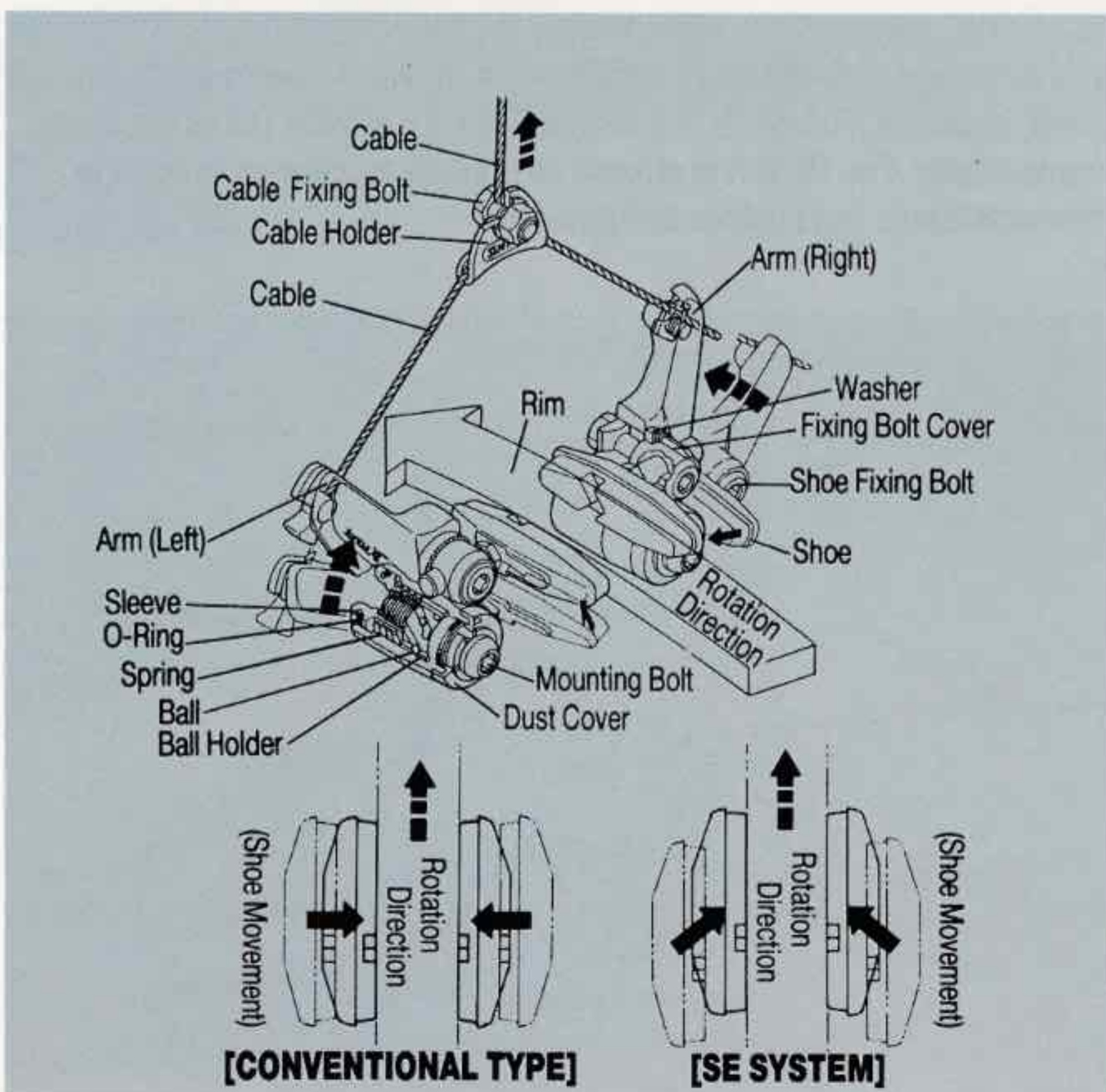

WILDERNESS TRAIL BIKES/SUNTOUR GREASE GUARD SYSTEM

GREASE GUARD



THE SUNTOUR GREASE GUARD SYSTEM Designed by WILDERNESS TRAIL BIKES

Traditional cup/cone type bearings require regular overhaul that can be messy and troublesome. In addition, an unsealed system is vulnerable to contaminants not only during use, but during disassembly and reassembly. We are happy to say there is a better way.

In January of 1989, SUNTOUR entered into a mutually beneficial licensing agreement with Wilderness Trail Bikes. As a result, SUNTOUR has incorporated the WTB Grease Guard Technology into the new XC-PRO group for 1990.

Grease injection ports are fitted to the hubs and bottom bracket. In the WTB SUNTOUR Grease Guard System, each bearing is individually addressed to guarantee replacement with fresh grease. Each grease port and passage leads to only one bearing, pushing contamination out where it entered.

The WTB SUNTOUR Grease Guard System has no more grease shear friction than conventional components. It allows for a 30 second overhaul with no compromises in weight or performance. The Grease Gun and WTB SUNTOUR Grease must be used and are included with the system. Committed off-road riders and racers have appreciated the outstanding performance and quality of WTB components, but until now it has not been available to such a broad market. WTB SUNTOUR Grease Guard components are available with the XC-PRO group for 1990.

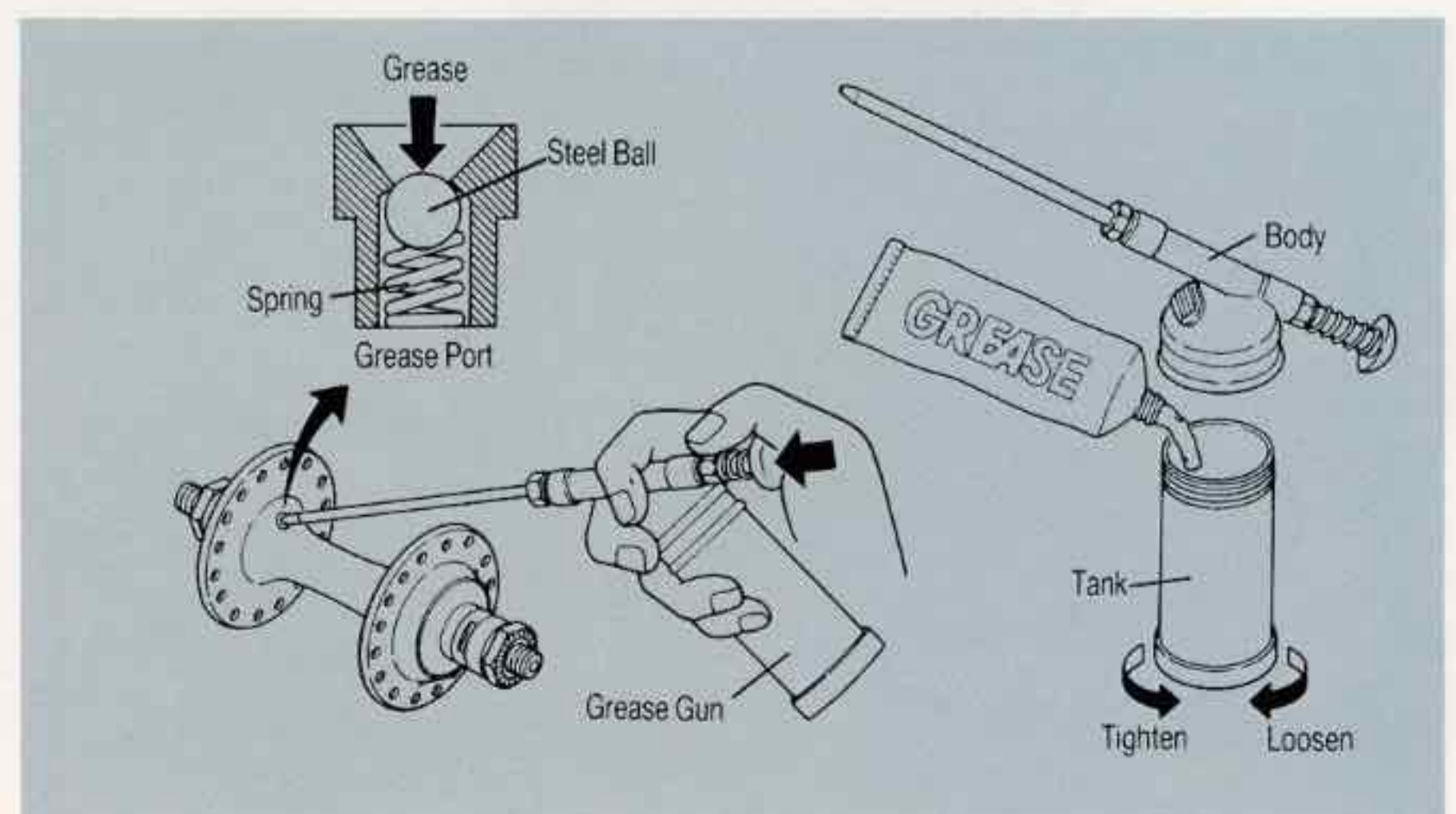

CHROMA



SUNTOUR X-1 CHROMA SYSTEM

X-1 is a newly designed group for 1990. It incorporates an improved rear derailleur, based on the popular XCD-6000, with brass pivot bushings and the return of the angle adjusting screw; a front derailleur available with 1-1/8" or 1-1/4" clamp and a patented inner cage plate design for faster shifting and greater shifting tolerances; the AccuShift Plus freewheel and chain; a new SR crank with the PowerRing/Anti-Jam Chainrings; and Dia-Compe's new compact brake levers with aluminum alloy bracket and lever and their compact aluminum cantilever with spring adjust mechanism. Options are the new X-Press Control lever, a cassette body hub, two-finger brake lever and a stainless steel inner chainring.

X-1 CHROMA is the X-1 group with interchangeable plastic NEON (yellow, pink or green) highlights snapped over the basic black X-1 finish on each component. SUNTOUR has introduced neon components in the past two race seasons, by supplying our sponsored off-road riders with special team-issue parts. The response to SUNTOUR's increased visibility on the race circuit has inspired the X-1 CHROMA group. It is an all new performance-based system that functions as well as it looks.

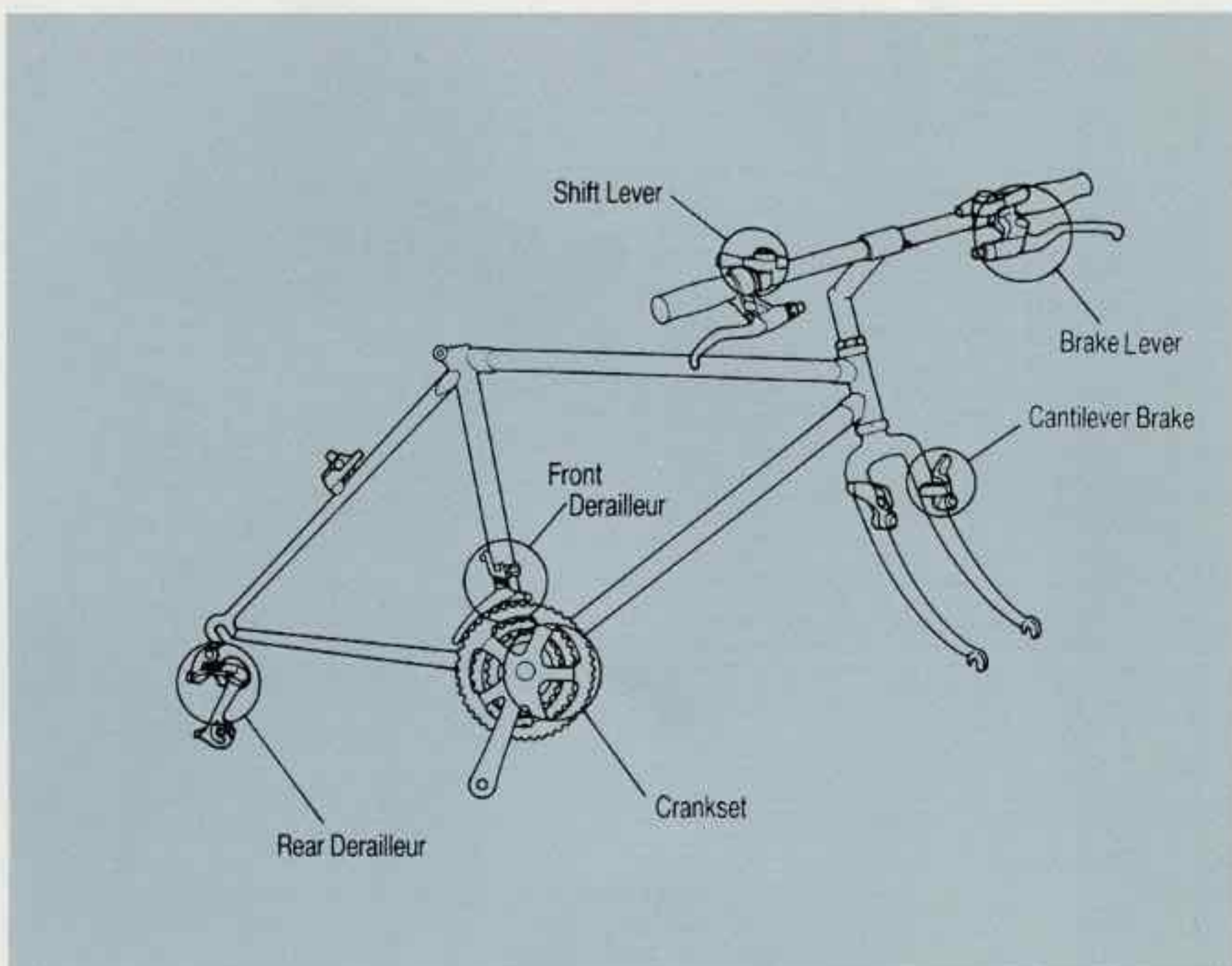

CARTRIDGE BEARING



SUNTOUR CARTRIDGE BEARING HUBS

When spun by hand under no load, a good cup/cone bearing hub can feel smoother and more free than a cartridge bearing hub. But in actual use, precision cartridge bearings are far superior.

SUNTOUR cartridge bearing hubs use single row radial contact annular bearings, which can sustain higher loads than conventional cup/cone type bearings. There is 75% less rotational resistance under load due to the high precision mirror polish of the bearing surfaces.

Under normal use a long, maintenance-free life is assured. However, if necessary, the bearings can be replaced using SUNTOUR tool model TA-340.

SUNTOUR CARTRIDGE BEARING PULLEY

SUNTOUR cartridge bearing pulleys reduce drive train friction with a patented system that incorporates double-sealed precision bearings, a Delrin plastic wheel, and aluminum alloy dust shields.

The following chart shows the difference in rotational resistance between the most common pulleys and the SUNTOUR cartridge bearing pulley. Under normal pedaling, an 80% decrease in rotating resistance is realized with the SUNTOUR pulley. In addition to the internals, a function-specific tooth profile further reduces friction as the chain contacts the guide pulley.

The cartridge bearing pulley is standard on the Superbe-Pro and XC-Pro rear derailleur and, as an upgrade, fits all SUNTOUR derailleurs and most other brands.

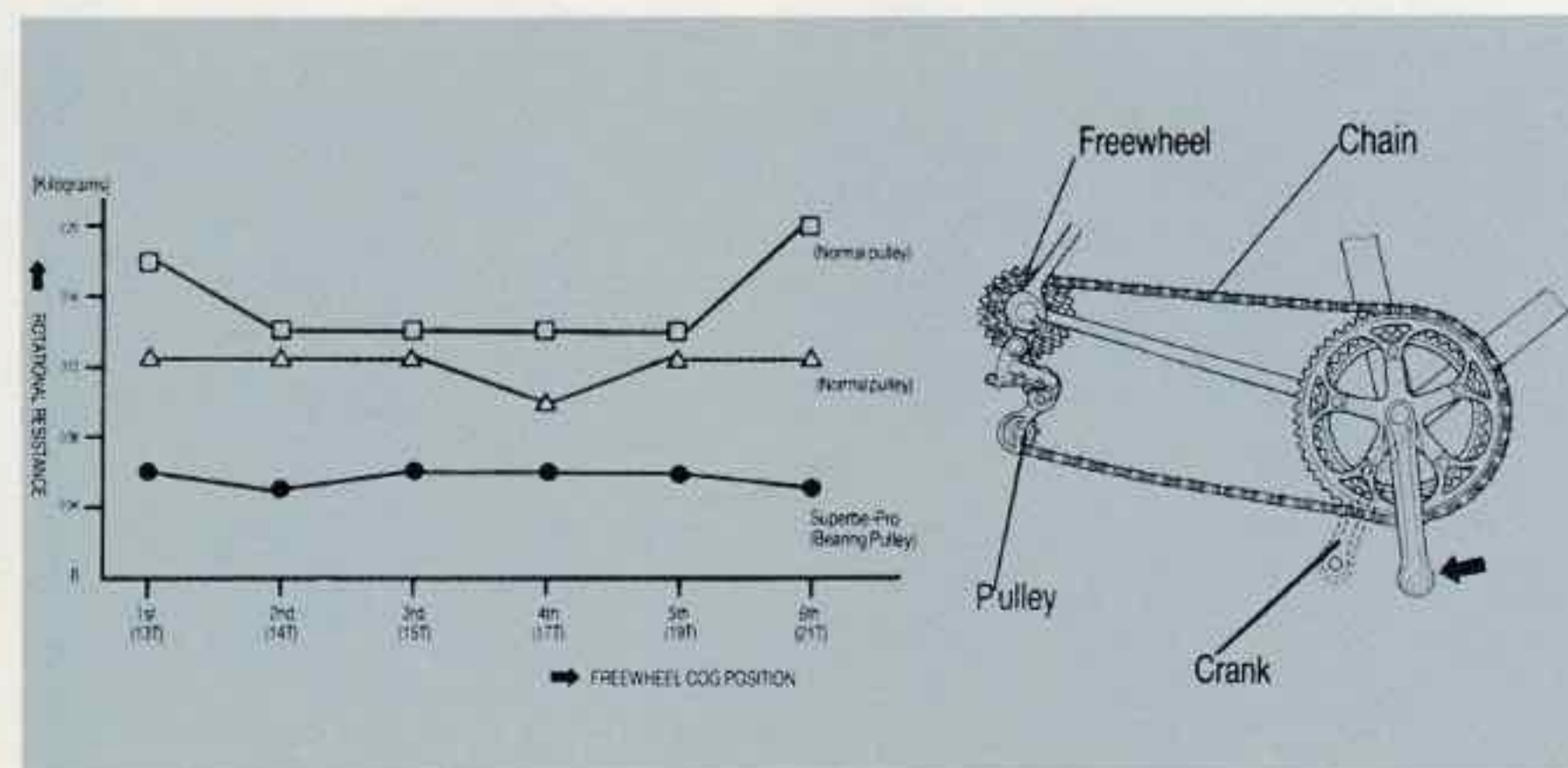

'90 NEW COMPONENTS SUNTOUR XC PRO

The off-road reference standard has been redefined. Our reply to racers wanting competition components with the seemingly contradictory features of toughness, light weight and compactness is the incredible SUNTOUR XC-PRO group. Completely new and incorporating such features as BEAST, WTB SUNTOUR Grease Guard, X-PRESS, AccuShift Plus, Multi-Mount, PowerRing and SE Brake; this revolutionary group weighs 15% - 40% less per part than anything else. Race use and abuse demands nothing less than SUNTOUR XC-PRO.



BEAST

X-PRESS
POWERING
AP CHAIN
AP COGS
AP SHIFTER
MULTI MOUNT
BEAST
SE
GREASE GUARD
CARTRIDGE BEARING



REAR DERAILLEUR
Model: RD-XP00-GXB (Code No.24039921)
Specifications
• ACCUSHIFT PLUS Compatible
• Largest rear sprocket:
30T (28mm dropout)
30T in Full index mode
• Total gear capacity:
40T (Maximum chainring difference: 22T)
• Weight: 274g

REAR DERAILLEUR
Model: RD-XP00-GTB (Code No.24029921)
Specifications
• ACCUSHIFT PLUS Compatible
• Largest rear sprocket:
30T (28mm dropout)
30T in Full index mode
• Total gear capacity:
34T (Maximum chainring difference: 16T)
• Weight: 265g

FRONT DERAILLEUR
Model: FD-XP00-GXH (Code No.29819911)
Clamp-on/28.6mm
FD-XP00-GXH (Code No.29819915)
Clamp-on/31.8mm

Specifications
• Gear capacity: 24T (22T w/oval chainring)
• Minimum chainring difference: Above 6T
• Clamp diameter: 1-1/8" (28.6mm)
1-1/4" (31.8mm)
• Weight: 115g/1-1/8" (28.6mm)

FRONT DERAILLEUR
(TOP PULL type)
Model: FD-TP00-GXH
(Code No.29889911) Clamp-on/28.6mm

Specifications
• Gear capacity: 24T (22T w/oval chainring)
• Minimum chainring difference: Above 6T
• Clamp diameter: 1-1/8" (28.6mm)
• Weight: 116g/1-1/8" (28.6mm)

SHIFT LEVER
Model: SL-XP00-R7U (Code No.33109571)
Right/7-Speed index
SL-XP00-L (Code No.33109701)
Left/Power ratchet

Specifications
• ACCUSHIFT PLUS Compatible
• Clamp diameter: 7/8" (22.2mm)
• Weight: 156g/pr.

Standard	Inner Cable		Outer Casing	
	Type	Length (mm)	Type	Length (mm)
Right (Rear)	029	2,000	751	600x280
Left (Front)	029	1,500	751	600

SHIFT LEVER
Model: SL-XP00-R6R (Code No.33109561)
Right/6-Speed index
SL-XP00-L (Code No.33109701)
Left/Power ratchet

Specifications
• ACCUSHIFT PLUS Compatible
• Clamp diameter: 7/8" (22.2mm)
• Weight: 156g/pr.

X-PRESS CONTROL LEVER
Model: SL-PP10-R7R
(Code No.33119571) Right/7-Speed index
Model: SL-PP10-L
(Code No.33119701) Left

Specifications
• ACCUSHIFT PLUS Compatible
• Clamp diameter: 7/8" (22.2mm)
• Weight: 296g/pr.

Standard	Inner Cable		Outer Casing	
	Type	Length (mm)	Type	Length (mm)
Right (Rear)	036	2,000	751	520x280
Left (Front)	036	1,500	751	520

X-PRESS CONTROL LEVER
Model: CL-XP00-R6R
(Code No.33119561) Right/6-Speed index
Model: CL-XP00-L
(Code No.33119701) Left

Specifications
• ACCUSHIFT PLUS Compatible
• Clamp diameter: 7/8" (22.2mm)
• Weight: 296g/pr.

CANTILEVER BRAKE (SE type) *NEW
Model: CT-XP10 (Code No.62689921)

Specifications
• Features: Self Energizing System
• Shoe adjustment range: 22.5~27.5mm
• Weight: 260g/pr.

CANTILEVER BRAKE
(Normal type)
Model: CT-XP00 (Code No.62689901)

Specifications
• Shoe adjustment range: 22.5~27.5mm
• Weight: 230g/pr.

BRAKE LEVER
Model: BL-XP00 (Code No.60209911)
Normal type
BL-XP00-S (Code No.60209901)
Short type

Specifications
• Reach adjustment range:
26mm (Normal type)
23mm (Short type)
• Clamp Diameter: 22.2mm
• Weight: 230g/pr.

Standard	Inner Cable		Outer Casing	
	Type	Length (mm)	Type	Length (mm)
Right	82	1,280	561	1,160
Left	82	680	561	560

CRANKSET
Model: CW-XP10
(Code No.51739947)
46T x 36T x 24T/L = 170.0mm
(Code No.51739951)
46T x 36T x 24T/L = 175.0mm
(Code No.51739955)
46T x 36T x 24T/L = 180.0mm

Specifications
• Features: PowerRing (46T x 36T x 24T, 26T)
• Taper size: VX
• Bolt circle diameter:
130mm (Outer & Middle)
74mm (Inner)
• Available chainrings: 46T x 36T x 26T
• Thread: BC 9/16" x 20T (English)
• Weight: 742g (46T x 36T x 24T/L = 170.0mm)

CHAIN
Model: CH-AP00
(Code No.50650116) Silver & silver

Specifications
• ACCUSHIFT PLUS Compatible
• Features: Dai-hard treated pin
• Size: 1/2" x 3/32" (Narrow size)
• Pin width: 7.3mm
• Weight: 326g (116 links)

CRANKSET
Model: BT-CW00 (Code No.48019925)
48T x 38T x 28T/L = 175.0mm

Specifications
• Features: BEAST
• Taper size: VX
• Thread: BC 9/16" x 20T (English)
• Weight: 930g (48T x 38T x 28T/L = 170.0mm)

BOTTOM BRACKET
Model: BB-XP00-E (Code No.51949901)
Grease Guard system
BB-XC00-E (Code No.51969901)
Normal type

Specifications
• Ball size: 1/4" x 11 pcs (w/bearing retainer)
• Taper size: VX
• Thread: BC 1.37" x 24T (English)
• B.B. Width: 68mm
• Weight: 351g (Grease Guard system)
312g (Normal type)

HUB (Grease Guard System)
Model: HB-XP00-F
(Code No.52929121) Front 32H/100mm
(Code No.52929131) Front 36H/100mm
Model: HB-XP00-R
(Code No.52929236) Rear 36H/130mm
(Code No.52929226) Rear 32H/130mm
(Code No.52929238) Rear 36H/135mm
Model: QR-XP00-F
(Code No.50249202)
Quick release skewer/Front (100mm)
Model: QR-XP00-R
(Code No.50249207)
Quick release skewer/Rear (130mm)
(Code No.50249208)
Quick release skewer/Rear (135mm)

Specifications
• Features: Grease Guard System
• Thread: BC 1.37" x 24T (English)
• "D" dimension: 37mm (130mm, 135mm)
• Weight: 552g/pr. (100/130mm)

FREEHUB
Model: FH-XP00-7U
(Code No.47629926) 32H/130mm, 7-Speed
(Code No.47629936) 36H/130mm, 7-Speed
(Code No.47629928) 32H/135mm, 7-Speed
(Code No.47629938) 36H/135mm, 7-Speed
Model: QR-XP00-R
(Code No.50249207)
Quick release skewer/Rear (130mm)
(Code No.50249208)
Quick release skewer/Rear (135mm)
Model: CS-AP00-S7U
(Code No.47179802)
Cassette cogs, 7-Speed/silver

Specifications
• ACCUSHIFT PLUS Compatible
• Weight: 450g (36H/130mm)

FREEHUB
Model: FH-XP00-6R
(Code No.47629916) 36H/130mm, 6-Speed
(Code No.47629906) 32H/130mm, 6-Speed
Model: QR-XP00-R
(Code No.50249207)
Quick release skewer/Rear (130mm)
Model: CS-AP00-S6R
(Code No.47169801)
Cassette cogs, 6-Speed/silver

Specifications
• ACCUSHIFT PLUS Compatible
• Weight: 450g (36H/130mm)

PEDAL
Model: PL-XP00 (Code No.53219901)
Specifications
• Thread: BC 9/16" x 20T (English)
• Weight: 302g/pr.

BOTTOM BRACKET
Model: BB-XP00-E (Code No.51949901) English
Specifications
• Ball size: 1/4" x 11 pcs (w/bearing retainer)
• Taper size: VX
• Thread: BC 1.37" x 24T (English)
*French, Italian thread available
• B.B. Width: 68mm, 70mm
• Weight: 351g

SELECTOR ASSEMBLY
Model: BT-SA00 (Code No.48039931) 28.6mm
(Code No.48039941) 31.8mm

Specifications
• Clamp diameter: 28.6mm (1-1/8") 31.8mm (1-1/4")
• Weight: 140g/28.6mm (1-1/8")

BATTERY ELECTRONIC HOUSING
Model: BT-BU00 (Code No.48079921) 28.6mm
(Code No.48079923) 31.8mm

Specifications
• Clamp diameter: 28.6mm (1-1/8") 31.8mm (1-1/4")
• Battery: 006P-9V Alkaline
• Weight: 110g/28.6mm (1-1/8")

SHIFT CONTROL SWITCH
Model: BT-SB00 (Code No.48039901)

Specifications
• Clamp diameter: 22.2mm (7/8")
• Weight: 25g

FREEWHEEL
Model: FW-AL10-S7U
(Code No.15079803) 7-Speed

Specifications
• ACCUSHIFT PLUS Compatible
• Thread: BC 1.37" x 24T (English)
• Compatible chain: 1/2" x 3/32" (Narrow size)
• Compatible "D" dimension: 37mm
• Standard gear ratio (Weight):
13 x 14 x 16 x 18 x 20 x 23 x 26T (460g)
13 x 14 x 17 x 19 x 21 x 24 x 28T (410g)
13 x 15 x 17 x 20 x 23 x 26 x 30T (520g)

FREEWHEEL
Model: FW-AL10-S6R (Code No.15069801)
6-Speed

Specifications
• ACCUSHIFT PLUS Compatible
• Thread: BC 1.37" x 24T (English)
• Compatible chain: 1/2" x 3/32"
• Compatible "D" dimension: 37mm
• Standard gear ratio (Weight):
13 x 15 x 17 x 20 x 23 x 26T (415g)
13 x 15 x 17 x 20 x 24 x 28T (440g)
14 x 16 x 19 x 22 x 26 x 30T (470g)

HEAD SET
Model: HS-XP00-E
(Code No.50169901) English
HS-XP00-0
(Code No.50169902) Oversize

Specifications
• Type: ATB
• Ball size: 5/32" x 26 pcs (English) 28 pcs (Oversize)
• Thread: BC 1" x 24T (English)
BC 1-1/8" x 26T (Oversize)
• Weight: 119g (English)
132g (Oversize)

SEAT POST
Model: SP-XC00
(Code No.53629764) 26.8mm/L = 300mm
(Code No.53629769) 27.0mm/L = 300mm
(Code No.53629775) 27.2mm/L = 300mm

Specifications
• Diameter: 25.0mm, 26.4mm, 26.6mm,
26.8mm, 27.0mm, 27.2mm
• Saddle angle adjustment range:
22-degrees
• Saddle rail diameter: 7-8mm
• Weight: 330g (26.8mm/L = 300mm)

VICE GRIP
Model: OT-GP10 (Code No.59040703)
Specifications
• Weight: 98g/pr.

SEAT POST BINDER
Model: SB-XP00 (Code No.50279903)
Specifications
• Useful skewer length: 18-38.5mm
• Weight: 63g



GREASE GUN KIT
OT-GG10



'90 NEW COMPONENTS
SUNTOUR XC COMP

Applying the same exacting specifications of the SUNTOUR XC-PRO components to a lower priced competition group was the assignment. XC-PRO is the raceable result. Weighing in within a few grams of the XC-COMP, but without Grease Guard, expert riders can realize state-of-the-art performance advantages without state-of-the-art cost.



- X-PRESS
- POWERING
- AP CHAIN
- AP COGS
- AP SHIFTER
- MULTI MOUNT
- SE
- CARTRIDGE BEARING



SCOPE LIGHT OT-SC00



FRONT DERAILLEUR
 Model: FD-XC10-GXH (Code No.29839911)
 Clamp-on/28.6mm
 FD-XC10-GXH (Code No.29839915)
 Clamp-on/31.8mm

Specifications
 • Gear capacity: 24T (22T w/oval chainring)
 • Minimum chainring difference: Above 6T
 • Clamp diameter: 1-1/8" (28.6mm)
 1-1/4" (31.8mm)
 • Weight: 115g/1-1/8" (28.6mm)

FRONT DERAILLEUR
 (TOP PULL type)
 Model: FD-TP00-GXH
 (Code No.29889911) Clamp-on/28.6mm

Specifications
 • Gear capacity: 24T (22T w/oval chainring)
 • Minimum chainring difference: Above 6T
 • Clamp diameter: 1-1/8" (28.6mm)
 • Weight: 116g/1-1/8" (28.6mm)

SHIFT LEVER
 Model: SL-XC10-R7U (Code No.33209571)
 Right/7-Speed index
 SL-XC10-L (Code No.33209701)
 Left/Power ratchet

Specifications
 • ACCUSHIFT PLUS Compatible
 • Clamp diameter: 7/8" (22.2mm)
 • Weight: 156g/pr.

Standard	Inner Cable		Outer Casing	
	Type	Length (mm)	Type	Length (mm)
Right (Rear)	029	2,000	751	500×280
Left (Front)	029	1,500	751	500

SHIFT LEVER
 Model: SL-XC10-R6R (Code No.33209561)
 Right/6-Speed index
 SL-XC10-L (Code No.33209701)
 Left/Power ratchet

Specifications
 • ACCUSHIFT PLUS Compatible
 • Clamp diameter: 7/8" (22.2mm)
 • Weight: 156g/pr.

X-PRESS CONTROL LEVER
 Model: SL-PP10-R7U
 (Code No.33119571) Right/7-Speed index
 Model: SL-PP10-L
 (Code No.33119701) Left

Specifications
 • ACCUSHIFT PLUS Compatible
 • Clamp diameter: 7/8" (22.2mm)
 • Weight: 296g/pr.

Standard	Inner Cable		Outer Casing	
	Type	Length (mm)	Type	Length (mm)
Right (Rear)	029	2,000	751	520×280
Left (Front)	029	1,500	751	520

REAR DERAILLEUR
 Model: RD-XC20-GXB (Code No.24099921)
Specifications
 • ACCUSHIFT PLUS Compatible
 • Largest rear sprocket: 30T (28mm dropout) 30T in Full index mode
 • Total gear capacity: 40T (Maximum chainring differential: 22T)
 • Weight: 262g

REAR DERAILLEUR
 Model: RD-XC20-GTB (Code No.24089921)
Specifications
 • ACCUSHIFT PLUS Compatible
 • Largest rear sprocket: 30T (28mm dropout) 30T in Full index mode
 • Total gear capacity: 34T (Maximum chainring differential: 16T)
 • Weight: 253g

X-PRESS CONTROL LEVER
 Model: SL-PP10-R6R
 (Code No.33119561) Right/6-Speed index
 Model: SL-PP10-L
 (Code No.33119701) Left
Specifications
 • ACCUSHIFT PLUS Compatible
 • Clamp diameter: 7/8" (22.2mm)
 • Weight: 296g/pr.

BRAKE LEVER
 Model: BL-XP00
 (Code No.60209911) Normal type
 Model: BL-XP00-S
 (Code No.60209901) Short type

Specifications
 • Reach adjustment range: 26mm (Normal type) 23mm (Short type)
 • Clamp Diameter: 22.2mm
 • Weight: 230g/pr.

Standard	Inner Cable		Outer Casing	
	Type	Length (mm)	Type	Length (mm)
Right	82	1,280	561	1,160
Left	82	680	561	560

CANTILEVER BRAKE (SE type)
 Model: CT-XP10 (Code No.62689921)
Specifications
 • Features: Self Energizing System
 • Shoe adjustment range: 22.5-27.5mm
 • Weight: 260g/pr.

CANTILEVER BRAKE
 (Normal type)
 Model: CT-XP00 (Code No.62689901)
Specifications
 • Shoe adjustment range: 22.5-27.5mm
 • Weight: 230g/pr.

POWER BRAKE
 Model: BA-XC00 (Code No.62229901)
Specifications
 • Shoe adjustment range: 33.5-42.5mm
 • Weight: 552g

CRANKSET
 Model: CW-XC10 (Code No.51589925)
 46T×36T×24T/L=170.0mm
 (Code No.51589929)
 46T×36T×24T/L=175.0mm

Specifications
 • Features: PowerRing (46T×36T×24T, 26T)
 • Taper size: VX
 • Bolt circle diameter: 130mm (Outer & Middle) 74mm (Inner)
 • Available chainrings: 46T×36T×26T
 • Thread: BC 9/16"×20T (English)
 • Weight: 732g (46T×36T×24T/170.0mm)

BOTTOM BRACKET
 Model: BB-XC00-E
 (Code No.51969901) English

Specifications
 • Ball size: 1/4"×11 pcs (w/bearing retainer)
 • Taper size: VX
 • Thread: BC 1.37"×24T (English)
 *French, Italian thread available
 • B.B. Width: 68mm, 70mm
 • Weight: 312g

PEDAL
 Model: PL-XC20 (Code No.53129901)
Specifications
 • Thread: BC 9/16"×20T (English)
 • Weight: 315g/pr.

CHAIN
 Model: CH-AP00
 (Code No.50650116) Silver & silver

Specifications
 • ACCUSHIFT PLUS Compatible
 • Features: Dai-hard treated pin
 • Size: 1/2"×3/32" (Narrow size)
 • Pin width: 7.3mm
 • Weight: 326g (116 links)

HUB
 Model: HB-XC01-F
 (Code No.52949131) Front 36H/100mm
 (Code No.52949121) Front 32H/100mm
 Model: HB-XC01-R
 (Code No.52949236) Rear 36H/130mm
 (Code No.52949226) Rear 32H/130mm
 (Code No.52949238) Rear 36H/135mm
 (Code No.52949228) Rear 32H/135mm
 Model: QR-XP00-F
 (Code No.50249202)
 Quick release skewer/Front (100mm)
 Model: QR-XP00-R
 (Code No.50249207)
 Quick release skewer/Rear (130mm)
 (Code No.50249208)
 Quick release skewer/Rear (135mm)

Specifications
 • Thread: BC 1.37"×24T (English)
 • "D" dimension: 37mm (130mm, 135mm)
 • Weight: 552g/pr. (100/130mm)

FREEHUB
 Model: FH-XP00-7U
 (Code No.47629926) 32H/130mm, 7-Speed
 (Code No.47629936) 36H/130mm, 7-Speed
 (Code No.47629928) 32H/135mm, 7-Speed
 (Code No.47629938) 36H/135mm, 7-Speed
 Model: QR-XP00-R
 (Code No.50249207)
 Quick release skewer/Rear (130mm)
 (Code No.50249208)
 Quick release skewer/Rear (135mm)
 Model: CS-AP00-S7U
 (Code No.47179802)
 Cassette cogs, 7-Speed/silver

Specifications
 • ACCUSHIFT PLUS Compatible
 • Weight: 450g (36H/130mm)

FREEHUB
 Model: FH-XP00-6R
 (Code No.47629916) 36H/130mm, 6-Speed
 (Code No.47629906) 32H/130mm, 6-Speed
 Model: QR-XP00-R
 (Code No.50249207)
 Quick release skewer/Rear (130mm)
 Model: CS-AP00-S6R
 (Code No.47169801)
 Cassette cogs, 6-Speed/silver

Specifications
 • ACCUSHIFT PLUS Compatible
 • Weight: 450g (36H/130mm)

FREEWHEEL
 Model: FW-AL10-S7U
 (Code No.15079802) 7-Speed

Specifications
 • ACCUSHIFT PLUS Compatible
 • Thread: BC 1.37"×24T (English)
 • Compatible chain: 1/2"×3/32" (Narrow size)
 • Compatible "D" dimension: 37mm
 • Standard gear ratio (Weight):
 13×14×16×18×20×23×26T (460g)
 13×15×17×19×21×24×28T (490g)
 13×15×17×20×23×26×30T (520g)

FREEWHEEL
 Model: FW-AL10-S6R
 (Code No.15069801) 6-Speed

Specifications
 • ACCUSHIFT PLUS Compatible
 • Thread: BC 1.37"×24T (English)
 • Compatible chain: 1/2"×3/32"
 • Compatible "D" dimension: 37mm
 • Standard gear ratio (Weight):
 13×15×17×20×23×26T (415g)
 13×15×17×20×24×28T (440g)
 14×16×19×22×26×30T (470g)

HEAD SET
 Model: HS-SA00-E
 (Code No.50179921) English

Specifications
 • Type: Road, Track & ATB
 • Ball size: 5/32"×22 pcs (w/Bearing retainer)
 • Thread: BC 1"×24T (English)
 • Weight: 119g (English)

SEAT POST
 Model: SP-XC00
 (Code No.53629764) 26.8mm/L=300mm
 (Code No.53629769) 27.0mm/L=300mm
 (Code No.53629775) 27.2mm/L=300mm

Specifications
 • Diameter: 25.0mm, 26.6mm, 26.8mm, 27.0mm, 27.2mm
 • Saddle angle adjustment range: 22-degrees
 • Saddle rail diameter: 7-8mm
 • Weight: 330g (26.8mm/L=300mm)

VICE GRIP
 Model: OT-GP10 (Code No.59040703)
Specifications
 • Weight: 98g/pr.

SEAT POST BINDER
 Model: SB-XP00 (Code No.50279903)
Specifications
 • Useful skewer length: 18-38.5mm
 • Weight: 63g



TEAM BAG PE-2400

'90 NEW COMPONENTS

SUNTOUR XC

Our most popular off-road components have gotten lighter, stronger and smoother. The new AccuShift Plus system will allow you to shift faster and smoother through mud, sand, slop or water. Offering derailleur, shift lever, brake lever and freewheel/hub options, this goal-oriented group for 1990 responds to any race or ride demand with the performance you'd expect from the direct descendant of the industry's very first off-road group, the legendary SUNTOUR XC.



X-PRESS
POWERING
AP CHAIN
AP COGS
AP SHIFTER
MULTI MOUNT
SE

WATER BOTTLE PE-1200



REAR DERAILLEUR

Model: RD-XD10-GXB (Code No.24199921)

Specifications

- ACCUSHIFT PLUS Compatible
- Largest rear sprocket: 30T (28mm dropout) 30T in Full index mode
- Total gear capacity: 40T (Maximum chainring differential: 22T)
- Weight: 305g

REAR DERAILLEUR

Model: RD-XD10-GTB (Code No.24189921)

Specifications

- ACCUSHIFT PLUS Compatible
- Largest rear sprocket: 30T (28mm dropout) 30T in Full index mode
- Total gear capacity: 34T (Maximum chainring differential: 16T)
- Weight: 261g

FRONT DERAILLEUR

Model: FD-XD10-GXH
(Code No.29859911) Clamp-on/28.6mm
(Code No.28959915) Clamp-on/31.8mm

Specifications

- Gear capacity: 24T (22T w/oval chainring)
- Minimum chainring difference: Above 6T
- Clamp diameter: 1-1/8" (28.6mm) 1-1/4" (31.8mm)
- Weight: 115g/1-1/8" (28.6mm)



TAILBAG PE-3100



SPROCKET REMOVER TA-131

FREE WHEEL & HUB VICE TA-120

REMOVER TA-320

X-PRESS CONTROL LEVER

Model: SL-PP10-R7U
(Code No.33119571) Right/7-Speed index
Model: SL-PP10-L
(Code No.33119701) Left

- Specifications**
- ACCUSHIFT PLUS Compatible
 - Clamp diameter: 7/8" (22.2mm)
 - Weight: 296g/pr.

Standard	Inner Cable		Outer Casing	
	Type	Length (mm)	Type	Length (mm)
Right (Rear)	029	2,000	751	520×280
Left (Front)	029	1,500	751	520

X-PRESS CONTROL LEVER

Model: SL-PP10-R6R
(Code No.33119561) Right/6-Speed index
Model: SL-PP10-L
(Code No.33119701) Left

- Specifications**
- ACCUSHIFT PLUS Compatible
 - Clamp diameter: 7/8" (22.2mm)
 - Weight: 296g/pr.

CANTILEVER BRAKE (SE type)

Model: CT-XD20 (Code No.62729921)

- Specifications**
- Features: Self Energizing System
 - Shoe adjustment range: 22.5-27.5mm
 - Weight: 260g/pr.

CANTILEVER BRAKE

(Normal type)
Model: CT-XD11 (Code No.62729901)

- Specifications**
- Shoe adjustment range: 22.5-27.5mm
 - Weight: 230g/pr.

POWER BRAKE

Model: BA-XD00 (Code No.62299082)

- Specifications**
- Shoe adjustment range: 33.5-42.5mm
 - Weight: 510g

BRAKE LEVER

Model: BL-XD10
(Code No.60269911) Normal type
Model: BL-XD10-S
(Code No.60269901) Short type

- Specifications**
- Reach adjustment range:
26mm (Normal type)
23mm (Short type)
 - Clamp Diameter: 22.2mm
 - Weight: 230g/pr.

Standard	Inner Cable		Outer Casing	
	Type	Length (mm)	Type	Length (mm)
Right	82	1,280	561	1,160
Left	82	680	561	560

CRANKSET

Model: CW-XD10
(Code No.51759947)
46T×36T×24T/L=170.0mm
(Code No.51759951)
46T×36T×24T/L=175.0mm

- Specifications**
- Features: PowerRing (46T×36T×24T, 26T)
 - Taper size: VX
 - Bolt circle diameter:
130mm (Outer & Middle)
74mm (Inner)
 - Available chainrings: 46T, 36T, 26T
 - Thread: BC 9/16"×20T (English)
 - Weight: 732g (46T×36T×24T/170.0mm)

BOTTOM BRACKET

Model: BB-XD10-E
(Code No.51089901) English

- Specifications**
- Ball size: 1/4"×9 pcs (w/bearing retainer)
 - Taper size: VX
 - Thread: BC 1.37"×24T (English)
*French, Italian thread available
 - B.B. Width: 68mm, 70mm
 - Weight: 312g

PEDAL

Model: PL-XD10 (Code No.53149901)

- Specifications**
- Thread: BC 9/16"×20T (English)
 - Weight: 395g/pr.

FREEHUB

Model: FH-XD11-7U
(Code No.47659936) 36H/130mm, 7-Speed
(Code No.47659934) 32H/130mm, 7-Speed
(Code No.47659938) 36H/135mm, 7-Speed
(Code No.47659928) 32H/135mm, 7-Speed
Model: QR-RA00-R
(Code No.50249197)
Quick release skewer/Rear (130mm)
(Code No.50249198)
Quick release skewer/Rear (135mm)
Model: CS-AP00-K7U
(Code No.47179702)
Cassette cogs, 7-Speed/silver

- Specifications**
- ACCUSHIFT PLUS Compatible
 - Weight: 470g (36H/130mm)

FREEHUB

Model: FH-XD00-6R
(Code No.47659916) 36H/130mm, 6-Speed
(Code No.47659914) 32H/130mm, 6-Speed
Model: QR-RA00-R
(Code No.50249197)
Quick release skewer/Rear (130mm)
Model: CS-AP00-KGR
(Code No.47169701)
Cassette cogs, 6-Speed/Black

- Specifications**
- ACCUSHIFT PLUS Compatible
 - Weight: 465g (36H/130mm)

HUB

Model: HB-XD01-FQ
(Code No.52959131) Front 36H/100mm
Model: HB-XD01-RQ
(Code No.52959236) Rear 36H/130mm
(Code No.52959226) Rear 32H/130mm
(Code No.52959238) Rear 36H/135mm
(Code No.52959228) Rear 32H/135mm
Model: QR-RA00-F
(Code No.50249192)
Quick release skewer/Front (100mm)
Model: QR-RA00-R
(Code No.50249197)
Quick release skewer/Rear (130mm)
(Code No.50249198)
Quick release skewer/Rear (135mm)

- Specifications**
- Thread: BC 1.37"×24T (English)
 - "D" dimension: 37mm
 - Weight: 565g/pr. (100/130mm)

HUB

Model: HB-XD11-FS
(Code No.52959311) Front 36H/100mm
Model: HB-XD11-RS
(Code No.52959317) Rear 36H/130mm
(Code No.52959319) Rear 36H/135mm

- Specifications**
- Thread: BC 1.37"×24T (English)
 - "D" dimension: 37mm (126mm, 130mm)
 - Weight: 565g/pr. (100/130mm)

FREEWHEEL

Model: FW-AL10-S7U
(Code No.15079703) 7-Speed

- Specifications**
- ACCUSHIFT PLUS Compatible
 - Thread: BC 1.37"×24T (English)
 - Compatible chain: 1/2"×3/32" (Narrow size)
 - Compatible "D" dimension: 37mm
 - Standard gear ratio (Weight):
13×14×16×18×20×23×26T (460g)
13×15×17×19×21×24×28T (490g)
13×15×17×20×23×26×30T (520g)

FREEWHEEL

Model: FW-AL10-K6R
(Code No.15069701) 6-Speed

- Specifications**
- ACCUSHIFT PLUS Compatible
 - Thread: BC 1.37"×24T (English)
 - Compatible chain: 1/2"×3/32"
 - Compatible "D" dimension: 37mm
 - Standard gear ratio (Weight):
13×15×17×20×23×26T (415g)
13×15×17×20×24×28T (440g)
14×16×19×22×26×30T (470g)

CHAIN

Model: CH-AP10
(Code No.50670116) Silver & black

- Specifications**
- ACCUSHIFT PLUS Compatible
 - Size: 1/2"×3/32" (Narrow size)
 - Pin width: 7.3mm
 - Weight: 326g (116 links)

HEAD SET

Model: HS-SA00-E
(Code No.50179921) English

- Specifications**
- Type: Road, Track & ATB
 - Ball size: 5/32"×22 pcs (w/Bearing retainer)
 - Thread: BC 1"×24T (English)
 - Weight: 119g (English)

SEAT POST

Model: SP-SU00
(Code No.53659935) 26.8mm/L=300mm
(Code No.53659941) 27.0mm/L=300mm
(Code No.53659945) 27.2mm/L=300mm

- Specifications**
- Diameter: 25.0mm, 26.6mm,
26.8mm, 27.0mm, 27.2mm
 - Saddle angle adjustment range:
22-degrees
 - Saddle rail diameter: 7-8mm
 - Weight: 330g (26.8mm/L=300mm)

VICE GRIP

Model: OT-GP10 (Code No.59040703)

- Specifications**
- Weight: 98g/pr.

SEAT POST BINDER

Model: SB-XP00 (Code No.50279903)

- Specifications**
- Useful skewer length: 18-38.5mm
 - Weight: 63g



FRONT DERAILLEUR

(TOP PULL type)
Model: FD-TP00-GXH
(Code No.29889911) Clamp-on/28.6mm

- Specifications**
- Gear capacity: 24T (22T w/oval chainring)
 - Minimum chainring difference: Above 6T
 - Clamp diameter: 1-1/8" (28.6mm)
 - Weight: 116g/1-1/8" (28.6mm)

SHIFT LEVER

Model: SL-XD10-R7U
(Code No.33309571) Right/7-Speed index
Model: SL-XD10-L
(Code No.33309701) Left/Power ratchet

- Specifications**
- ACCUSHIFT PLUS Compatible
 - Clamp diameter: 7/8" (22.2mm)
 - Weight: 181g/pr.

Standard	Inner Cable		Outer Casing	
	Type	Length (mm)	Type	Length (mm)
Right (Rear)	029	2,000	751	500×280
Left (Front)	029	1,500	751	500

SHIFT LEVER

Model: SL-XD10-R6R
(Code No.33309561) Right/6-Speed index
Model: SL-XD10-L
(Code No.33309701) Left/Power ratchet

- Specifications**
- ACCUSHIFT PLUS Compatible
 - Clamp diameter: 7/8" (22.2mm)
 - Weight: 181g/pr.



'90 NEW COMPONENTS

SUNTOUR X-1

All new. All hot. All fast. Whether all black or with neon highlights, this race-ready group has all the trick features, all the buttons and all the muscle of our top groups. With AccuShift Plus chain and freewheel, PowerRing and optional instant shift X-PRESS levers, this stuff is not going to sit still for long. Ride it NOW.



CYCLE BANDANA PE-2200

SHOULDER HOLDER OG-SH00

X-PRESS
POWERING
AP
CHAIN
COGS
AP
SHIFTER

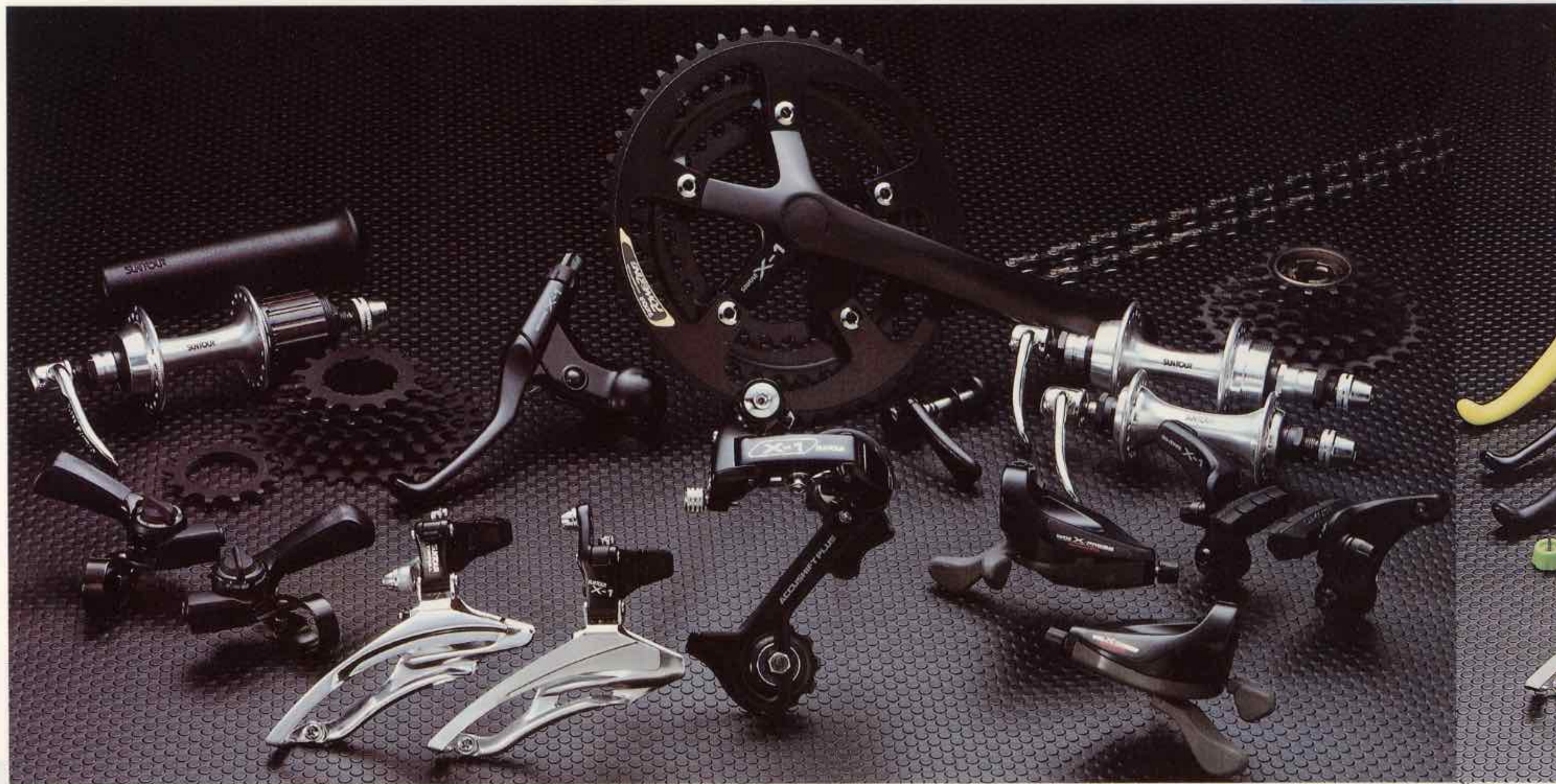

REAR DERAILLEUR

Model: RD-X100-GXB (Code No.23399921)

Specifications

- ACCUSHIFT PLUS Compatible
- Largest rear sprocket: 32T (28mm dropout) 32T in Full index mode
- Total gear capacity: 40T (Maximum chainring differential: 22T)
- Weight: 311g

FRONT DERAILLEUR

Model: FD-X100-GXH (Code No.29019811) Clamp-on/28.6mm (Code No.29019815) Clamp-on/31.8mm

Specifications

- Gear capacity: 24T (22T w/oval chainring)
- Minimum chainring difference: Above 6T
- Clamp diameter: 1-1/8" (28.6mm) 1-1/4" (31.8mm)
- Weight: 109g/1-1/8" (28.6mm)

FRONT DERAILLEUR

(TOP PULL type) Model: FD-TP00-GXH (Code No.29889911) Clamp-on/28.6mm

Specifications

- Gear capacity: 24T (22T w/oval chainring)
- Minimum chainring difference: Above 6T
- Clamp diameter: 1-1/8" (28.6mm)
- Weight: 116g/1-1/8" (28.6mm)

SHIFT LEVER

Model: SL-X100-R7U (Code No.33409571) Right/7-Speed index Model: SL-X100-L (Code No.33409701) Left/Power ratchet

Specifications

- ACCUSHIFT PLUS Compatible
- Clamp diameter: 7/8" (22.2mm)
- Weight: 182g/pr.

Standard	Inner Cable		Outer Casing	
	Type	Length (mm)	Type	Length (mm)
Right (Rear)	029	2,000	751	500x280
Left (Front)	029	1,500	751	500

VICE GRIP

Model: OT-GP10 (Code No.59049903)

Specifications

- Weight: 98g/pr.

SHIFT LEVER

Model: SL-X100-R6R (Code No.33409561) Right/6-Speed index Model: SL-X100-L (Code No.33409701) Left/Power ratchet

Specifications

- ACCUSHIFT PLUS Compatible
- Clamp diameter: 7/8" (22.2mm)
- Weight: 182g/pr.

X-PRESS CONTROL LEVER

Model: SL-PP00-R7U (Code No.33519571) Right/7-Speed index Model: SL-PP00-L (Code No.33519701) Left

Specifications

- ACCUSHIFT PLUS Compatible
- Clamp diameter: 7/8" (22.2mm)
- Weight: 296g/pr.

Standard	Inner Cable		Outer Casing	
	Type	Length (mm)	Type	Length (mm)
Right (Rear)	029	2,000	751	520x280
Left (Front)	029	1,500	751	520

X-PRESS CONTROL LEVER

Model: SL-PP00-R6R (Code No.33519561) Right/6-Speed index Model: SL-PP00-L (Code No.33519701) Left

Specifications

- ACCUSHIFT PLUS Compatible
- Clamp diameter: 7/8" (22.2mm)
- Weight: 296g/pr.

CANTILEVER BRAKE

Model: CT-X100 (Code No.62249001)

Specifications

- Shoe adjustment range: 20-30mm
- Weight: 193g/pr.

CHAIN

Model: CH-AP10 (Code No.50670116) Silver & black

Specifications

- ACCUSHIFT PLUS Compatible
- Size: 1/2" x 3/32" (Narrow size)
- Pin width: 7.3mm
- Weight: 326g (116 links)

BRAKE LEVER

Model: BL-X100-S (Code No.60249903) Short type

Specifications

- Reach adjustment range: 23mm (Short type)
- Clamp diameter: 22.2mm
- Weight: 268g/pr. (Short type)

Standard	Inner Cable		Outer Casing	
	Type	Length (mm)	Type	Length (mm)
Right	82	1,250	251	1,150
Left	82	600	251	500

CRANKSET

Model: CW-X100 (Code No.51409902) 48T x 38T x 28T/L = 165.0mm (Code No.51409912) 48T x 38T x 28T/L = 170.0mm (Code No.51409922) 48T x 38T x 28T/L = 175.0mm

Specifications

- Features: PowerRing (48T x 38T x 28T only)
- Taper size: VX
- Bolt circle diameter: 130mm (Outer & Middle) 74mm (Inner)
- Thread: BC 9/16" x 20T (English)
- Weight: 745g (48T x 38T x 28T/170.0mm)

BOTTOM BRACKET

Model: BB-X100-E (Code No.51049901) English

Specifications

- Ball size: 1/4" x 9 pcs (w/bearing retainer)
- Taper size: VX
- Thread: BC 1.37" x 24T (English) *French, Italian thread available
- B.B. Width: 68mm, 70mm
- Weight: 354g

PEDAL

Model: PL-X100 (Code No.53199901)

Specifications

- Thread: BC 9/16" x 20T (English)
- Weight: 364g/pr.

HUB

Model: HB-AT00-FQ (Code No.52969131) Front 36H/100mm (Code No.52969121) Front 32H/100mm Model: QR-RA00-F (Code No.50249192) Quick release skewer/Front (100mm) Model: HB-AT00-RQ (Code No.52969234) Rear 36H/126mm (Code No.52969224) Rear 32H/126mm (Code No.52969236) Rear 36H/130mm (Code No.52969226) Rear 32H/130mm Model: QR-RA00-R (Code No.50249196) Quick release skewer/Rear (126mm) (Code No.50249197) Quick release skewer/Rear (130mm)

Specifications

- Thread: BC 1.37" x 24T (English)
- "D" dimension: 37mm (126mm, 130mm)
- Weight: 574g/pr. (100/126mm)

HUB

Model: HB-AT00-FS (Code No.52969305) Front 36H/100mm Model: HB-AT00-RS (Code No.52969484) Rear 36H/126mm (Code No.52969309) Rear 36H/130mm

Specifications

- Thread: BC 1.37" x 24T (English)
- "D" dimension: 37mm (126mm, 130mm)
- Weight: 504g/pr. (100/126mm)

FREEHUB

Model: FH-AT00-7U (Code No.47669934) 36H/126mm, 7-Speed (Code No.47669924) 32H/126mm, 7-Speed (Code No.47669936) 36H/130mm, 7-Speed (Code No.47669926) 32H/130mm, 7-Speed Model: QR-RA00-R (Code No.50249196) Quick release skewer/Rear (126mm) (Code No.50249197) Quick release skewer/Rear (130mm) Model: CS-AP00-K7U (Code No.47179702) Cassette cogs, 7-Speed/black

Specifications

- ACCUSHIFT PLUS Compatible
- Weight: 465g (36H/126mm)

FREEHUB

Model: FH-AT00-GR (Code No.47669914) 36H/126mm, 6-Speed (Code No.47669904) 32H/126mm, 6-Speed (Code No.47669916) 36H/130mm, 6-Speed (Code No.47669906) 32H/130mm, 6-Speed Model: QR-RA00-R (Code No.50249196) Quick release skewer/Rear (126mm) (Code No.50249197) Quick release skewer/Rear (130mm) Model: CS-AP00-K6R (Code No.47169701) Cassette cogs, 6-Speed/black

Specifications

- ACCUSHIFT PLUS Compatible
- Weight: 465g (36H/126mm)

FREEWHEEL

Model: FW-AL10-K7U (Code No.15079703) 7-Speed

Specifications

- ACCUSHIFT PLUS Compatible
- Thread: BC 1.37" x 24T (English)
- Compatible chain: 1/2" x 3/32" (Narrow size)
- Compatible "D" dimension: 37mm
- Standard gear ratio (Weight): 13x14x16x18x20x23x26T (460g) 13x15x17x19x21x24x28T (490g) 13x15x17x20x23x26x30T (520g)

FREEWHEEL

Model: FW-AL10-K6R (Code No.15069701) 6-Speed

Specifications

- ACCUSHIFT PLUS Compatible
- Thread: BC 1.37" x 24T (English)
- Compatible chain: 1/2" x 3/32"
- Compatible "D" dimension: 37mm
- Standard gear ratio (Weight): 13x15x17x20x23x26T (415g) 13x15x17x20x24x28T (440g) 14x16x19x22x26x30T (470g)

SEAT POST BINDER

Model: SB-XP00 (Code No.50279903)

Specifications

- Useful skewer length: 18-38.5mm
- Weight: 63g

'90 NEW COMPONENTS SUNTOUR X-1 CHROMA



REAR DERAILLEUR
Model: RD-CR00-GXB
(Code No.23399931) Pink
(Code No.23399933) Green
(Code No.23399935) Yellow

FRONT DERAILLEUR
Model: FD-CR00-GXH
(Code No.29019841)
Clamp-on/28.6mm, Pink
(Code No.29019842)
Clamp-on/28.6mm, Green
(Code No.29019843)
Clamp-on/28.6mm, Yellow

SHIFT LEVER
Model: SL-CR00-R7U
(Code No.33419571)
Right/7-Speed index (Pink)
(Code No.33419573)
Right/7-Speed index (Green)
(Code No.33419575)
Right/7-Speed index (Yellow)
Model: SL-CR00-L
(Code No.33419701)
Left/Power ratchet (Pink)
(Code No.33419703)
Left/Power ratchet (Green)
(Code No.33419705)
Left/Power ratchet (Yellow)

SHIFT LEVER
Model: SL-CR00-R6R
(Code No.33419561)
Right/6-Speed index (Pink)
(Code No.33419563)
Right/6-Speed index (Green)
(Code No.33419565)
Right/6-Speed index (Yellow)
Model: SL-CR00-L
(Code No.33419701)
Left/Power ratchet (Pink)
(Code No.33419703)
Left/Power ratchet (Green)
(Code No.33419705)
Left/Power ratchet (Yellow)

CANTILEVER BRAKE
Model: CT-CR00
(Code No.62249003) Pink
(Code No.62249005) Green
(Code No.62249007) Yellow

BRAKE LEVER
Model: BL-CR00
(Code No.60249923) Normal type/Pink
(Code No.60249925) Normal type/Green
(Code No.60249927) Normal type/Yellow
Model: BL-CR00-S
(Code No.60249903) Short type/Pink
(Code No.60249905) Short type/Green
(Code No.60249907) Short type/Yellow

CRANKSET
Model: CW-CR00
(Code No.51409903)
48x38x28xT/L=165.0mm (Pink)
(Code No.51409905)
48x38x28xT/L=165.0mm (Green)
(Code No.51409907)
48x38x28xT/L=165.0mm (Yellow)
(Code No.51409913)
48x38x28xT/L=170.0mm (Pink)
(Code No.51409915)
48x38x28xT/L=170.0mm (Green)
(Code No.51409917)
48x38x28xT/L=170.0mm (Yellow)
(Code No.51409923)
48x38x28xT/L=175.0mm (Pink)
(Code No.51409925)
48x38x28xT/L=175.0mm (Green)
(Code No.51409927)
48x38x28xT/L=175.0mm (Yellow)



'90 NEW COMPONENTS SUNTOUR XCE



REAR DERAILLEUR
Model: RD-XE00-GXB (Code No.23499921)

FRONT DERAILLEUR
Model: FD-XE00-GXH
(Code No.29039811)
Clamp-on type 1-1/8" (28.6mm)
(Code No.29039815)
Clamp-on type 1-1/4" (31.8mm)

FRONT DERAILLEUR
Model: FD-TP00-GXH
(Code No.29839951)
Clamp-on type 1-1/8" (28.6mm)

SHIFT LEVER
Model: SL-XE00-R7U
(Code No.33509571) Right/7-Speed index
Model: SL-XE00-R6R
(Code No.33509561) Right/6-Speed index
Model: SL-XE00-L
(Code No.33509701) Left

X-PRESS CONTROL
Model: SL-PP00-R7U
(Code No.33519571) Right/7-Speed index
Model: SL-PP00-R6R
(Code No.33519561) Right/6-Speed index
Model: SL-PP00-L
(Code No.33519701) Left

CANTILEVER BRAKE
Model: CT-XE00 (Code No.62769901)

BRAKE CALIPER *NEW
Model: BA-XE00 (Code No.62179901)

BRAKE LEVER
Model: BL-XE00-S
(Code No.60319903) Short type
Model: BL-XE00
(Code No.60319901) Normal type

CRANKSET
Model: CW-XE00
(Code No.51689851)
48Tx38Tx28T/L=165.0mm
(Code No.51689855)
48Tx38Tx28T/L=170.0mm
(Code No.51689859)
48Tx38Tx28T/L=175.0mm

BOTTOM BRACKET
Model: BB-XI00
(Code No.51049901) English

PEDAL *NEW
Model: PL-XE00 (Code No.53209911)

HUB
Model: HB-AT00-FQ
(Code No.52969131) Front 36H/100mm
(Code No.52969121) Front 32H/100mm
Model: QR-RA00-F
(Code No.50249197)
Quick release skewer/Front (100mm)
Model: HB-AT00-RQ
(Code No.52969234) Rear 36H/126mm
(Code No.52969224) Rear 32H/126mm
(Code No.52969236) Rear 36H/130mm
(Code No.52969226) Rear 32H/130mm
Model: QR-RA00-R
(Code No.50249196)
Quick release skewer/Rear (126mm)
(Code No.50249197)
Quick release skewer/Rear (130mm)

HUB
Model: HB-AT00-FS
(Code No.52969305) Front 36H/100mm
Model: HB-AT00-RS
(Code No.52969484) Rear 36H/126mm
(Code No.52969309) Rear 36H/130mm

FREEWHEEL
Model: FW-AL10-K7U
(Code No.15079703) 7-Speed

FREEWHEEL
Model: FW-AL10-K6R
(Code No.15069701) 6-Speed

CHAIN *NEW
Model: CH-AP10 (Code No.50670116)

FREEHUB
Model: FH-AT00-7U
(Code No.47669934) 36H/126mm, 7-Speed
(Code No.47669924) 32H/126mm, 7-Speed
(Code No.47669936) 36H/130mm, 7-Speed
(Code No.47669926) 32H/130mm, 7-Speed
Model: QR-RA00-R
(Code No.50249196)
Quick release skewer/Rear (126mm)
(Code No.50249197)
Quick release skewer/Rear (130mm)
Model: CS-AP00-K7U
(Code No.47179702)
Cassette cogs, 7-Speed/Black

FREEHUB
Model: FH-AT00-6R
(Code No.47669914) 36H/126mm, 6-Speed
(Code No.47669904) 32H/126mm, 6-Speed
(Code No.47669916) 36H/130mm, 6-Speed
(Code No.47669906) 32H/130mm, 6-Speed
Model: QR-RA00-R
(Code No.50249196)
Quick release skewer/Rear (126mm)
(Code No.50249197)
Quick release skewer/Rear (130mm)
Model: CS-AP00-K6R
(Code No.47169701)
Cassette cogs, 6-Speed/Black



WIRE CUTTER TA-110

90 NEW COMPONENTS SUNTOUR X-1

'90 NEW COMPONENTS SUNTOUR XCM



**X-PRESS
POWERING
AP CHAIN
AP COGS
AP SHIFTER**

REAR DERAILLEUR
Model: RD-XM00-GXB (Code No.23599921)

FRONT DERAILLEUR
Model: FD-XM00-GXH
(Code No.29089812)
Clamp-on type 1-1/8" (28.6mm)
(Code No.29089816)
Clamp-on type 1-1/4" (31.8mm)

SHIFT LEVER
Model: SL-XM00-R7U
(Code No.33609571) Right/7-Speed index
Model: SL-XM00-R6R
(Code No.33609561) Right/6-Speed index
Model: SL-XM00-L
(Code No.33609701) Left

X-PRESS CONTROL
Model: SL-PP00-R7U
(Code No.33519571) Right/7-Speed index
Model: SL-PP00-R6R
(Code No.33519561) Right/6-Speed index
Model: SL-PP00-L
(Code No.33519701) Left

CANTILEVER BRAKE
Model: CT-XM00 (Code No.62779901)

BRAKE LEVER
Model: BL-XM00
(Code No.60329901) Normal type

CRANKSET
Model: CW-XM00
(Code No.51709851)
48T×38T×28T/L=165.0mm
(Code No.51709855)
48T×38T×28T/L=170.0mm
(Code No.51709859)
48T×38T×28T/L=175.0mm

BOTTOM BRACKET *NEW
Model: BB-XM00
(Code No.51059901) English

PEDAL
Model: PL-XM00 (Code No.53179901)

HUB
Model: HB-AT00-FS
(Code No.52969305) Front 36H/100mm
Model: HB-AT00-RS
(Code No.52969484) Rear 36H/126mm
(Code No.52969309) Rear 36H/130mm

HUB
Model: HB-AT00-FQ
(Code No.52969131) Front 36H/100mm
(Code No.52969121) Front 32H/100mm
Model: QR-RA00-F
(Code No.50249192)
Quick release skewer/Front (100mm)
Model: HB-AT00-RQ
(Code No.52969234) Rear 36H/126mm
(Code No.52969224) Rear 32H/126mm
(Code No.52969236) Rear 36H/130mm
(Code No.52969226) Rear 32H/130mm
Model: QR-RA00-R
(Code No.50249196)
Quick release skewer/Rear (126mm)
(Code No.50249197)
Quick release skewer/Rear (130mm)

FREEWHEEL
Model: FW-AL10-K7U
(Code No.15079703) 7-Speed

FREEWHEEL
Model: FW-AL10-K6R
(Code No.15069701) 6-Speed

CHAIN
Model: CH-AP20 (Code No.50690116)

CHAIN *NEW
Model: CH-AP50 (Code No.50700116)

'90 NEW COMPONENTS SUNTOUR XCI

**X-PRESS
POWERING
AP CHAIN
AP COGS
AP SHIFTER**



REAR DERAILLEUR
Model: RD-XT00-GX
(Code No.23699901) w/Bracket
Model: RD-XT00-GXB
(Code No.23699921)

REAR DERAILLEUR
Model: RD-XT10-GX
(Code No.23689901) w/Bracket
Model: RD-XT10-GXB
(Code No.23699921)

FRONT DERAILLEUR *NEW
Model: FD-XT00-GXH (Code No.29079811)
Clamp-on type 1-1/8" (28.6mm)

SHIFT LEVER
Model: SL-XT00-R7U
(Code No.33709571) Right/7-Speed index
Model: SL-XT00-R6R
(Code No.33709561) Right/6-Speed index
Model: SL-XT00-L
(Code No.33709701) Left

X-PRESS CONTROL
Model: SL-PP00-R7U
(Code No.33519571) Right/7-Speed index
Model: SL-PP00-R6R
(Code No.33519561) Right/6-Speed index
Model: SL-PP00-L
(Code No.33519701) Left

CANTILEVER BRAKE
Model: CT-XT00 (Code No.62789901)

BRAKE LEVER
Model: BL-XT00 (Code No.60339901)

CRANKSET
Model: CW-XT00
(Code No.51569921)
48T×38T×28T/L=165.0mm
(Code No.51569925)
48T×38T×28T/L=170.0mm
(Code No.51569929)
48T×38T×28T/L=175.0mm

BOTTOM BRACKET
Model: BB-X100
(Code No.51049901) English

PEDAL
Model: PL-XT00 (Code No.53189901)

FREEWHEEL
Model: FW-AL10-K7U
(Code No.15079703) 7-Speed

FREEWHEEL
Model: FW-AL10-K6R
(Code No.15069701) 6-Speed

CHAIN
Model: CH-AP20 (Code No.50690116)

CHAIN
Model: CH-AP50 (Code No.50700116)

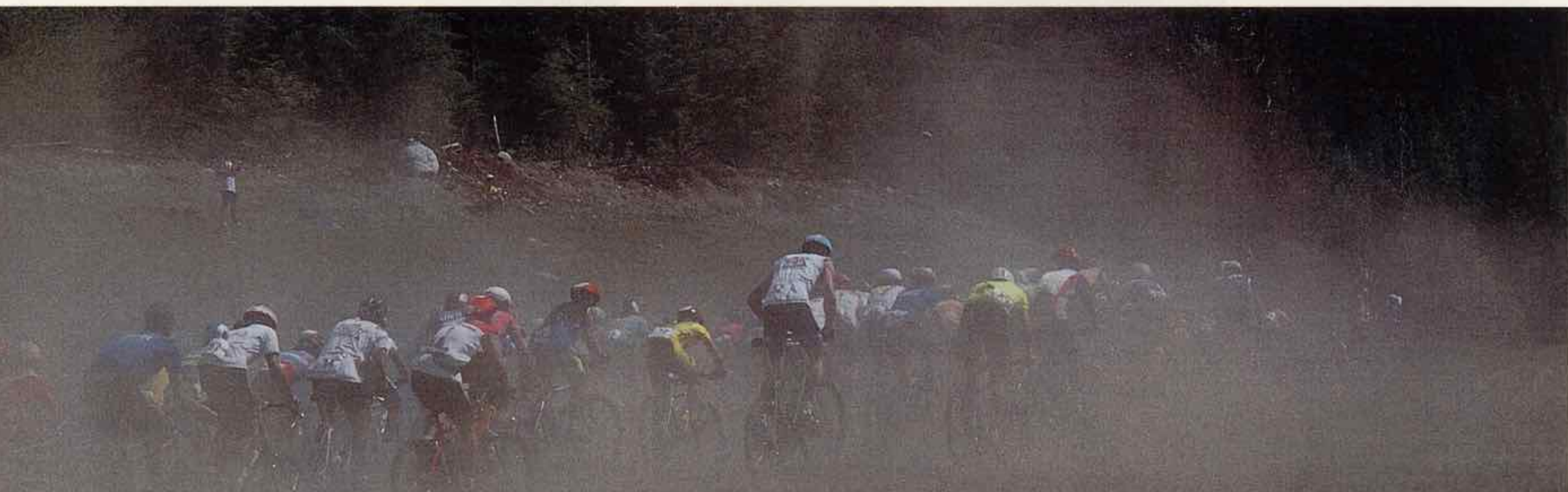

'90 NEW COMPONENTS
SUNTOUR
AC 2000



AP CHAIN
AP COGS
AP SHIFTER

REAR DERAILLEUR
Model: RD-A200-GX
(Code No.23799901) w/Bracket
Model: RD-A200-GXB
(Code No.23799921)

FRONT DERAILLEUR
Model: FD-A200-GXH (Code No.29099811)
Clamp-on type 1-1/8" (28.6mm)

SHIFT LEVER
Model: SL-A200-CH6R
(Code No.33909561) Right/6-Speed index
Model: SL-A200-CHL
(Code No.33909701) Left

SHIFT LEVER
Model: SL-2001-CHR
(Code No.31529907) Right
Model: SL-2001-CHL
(Code No.31529927) Left

FREEWHEEL
Model: FW-AL10-K6R
(Code No.15069701) 6-Speed

CHAIN
Model: CH-AP20 (Code No.50690116)

CHAIN *NEW
Model: CH-AP50 (Code No.50700116)

'90 NEW COMPONENTS
SUNTOUR
AC 1000



REAR DERAILLEUR
Model: RD-A100-GX
(Code No.23849901) w/Bracket
Model: RD-A100-GXB
(Code No.23849921)

FRONT DERAILLEUR
Model: FD-AT00-GXH (Code No.29739911)
Clamp-on type 1-1/8" (28.6mm)

SHIFT LEVER
Model: SL-AT10-CHR
(Code No.31619901) Right
Model: SL-AT10-CHL
(Code No.31619921) Left

SHIFT LEVER
Model: SL-2001-CHR
(Code No.31529907) Right
Model: SL-2001-CHL
(Code No.31529927) Left

'90 NEW COMPONENTS
SUNTOUR FT



AP CHAIN
AP COGS
ACCUSHIFT PLUS

REAR DERAILLEUR
Model: RD-FT50-SSB (Code No.23629921)

FRONT DERAILLEUR
Model: FD-FT50-SSH
(Code No.29049911) Clamp-on type

FRONT DERAILLEUR
Model: FD-VX00-SSH
(Code No.29069911) Clamp-on type

SHIFT LEVER
Model:
SL-FT50-R7U (Code No.33809571)
7-Speed/Handlebar clamp-on type
SL-FT50-R6R (Code No.33809561)
6-Speed/Handlebar clamp-on type
SL-BE00-CP7U (Code No.34109941)
7-Speed/Handlebar-stem clamp-on
SL-FT60-B7U (Code No.32519841)
7-Speed/Braze-on type
SL-FT60-C7U (Code No.32519941)
7-Speed/Clamp-on type
SL-FT60-B6R (Code No.32519822)
6-Speed/Braze-on type
SL-FT60-C6R (Code No.32519921)
6-Speed/Clamp-on type

BRAKE CALIPER *NEW
Model: BA-FT50 (Code No.62189003)

BRAKE LEVER *NEW
Model: BL-FT50
(Code No.60179901)

CRANKSET
Model: CW-FT50-AL (Code No.51399903)
Single/Alloy
CW-FT50-FE (Code No.51399907)
Single/Steel
CW-FT51-AL (Code No.51399933)
Double/Alloy
CW-FT51-FE (Code No.51399937)
Double/Steel

BOTTOM BRACKET
Model: BB-FT50-E (Code No.51069901)

HUB BRAKE
Model: DB-FT50 (Code No.62919901)

FREEWHEEL
Model: FW-AL10-K7U
(Code No.15079703) 7-Speed

FREEWHEEL
Model: FW-AL10-K6R
(Code No.15069701) 6-Speed

CHAIN
Model: CH-AP20 (Code No.50690116)

CHAIN
Model: CH-AP50 (Code No.50700116)

MAXXAD

...the most powerful machine, so that
...the machine will allow you to work
...the most powerful machine, so that
...the machine will allow you to work
...the most powerful machine, so that
...the machine will allow you to work

STRENGTHEN YOURSELF

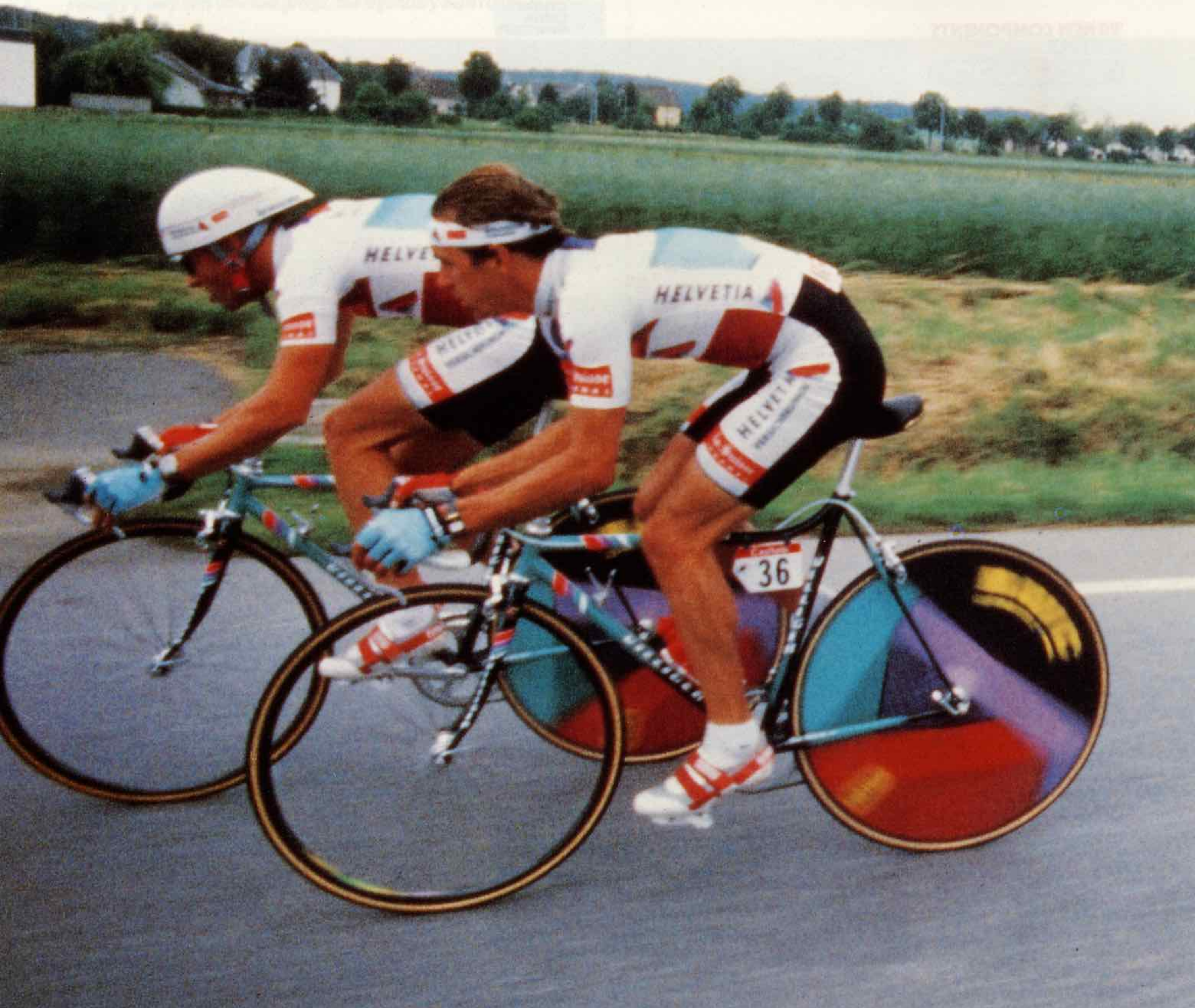

SUNTOUR: BUILT FOR SPEED



SUNTOUR SUPERBE PRO

When getting to the finish line is your job, you can't afford to ride anything but the best. Three top European Pro teams, Super Confex, Team Helvetia-La Suisse and Team Stuttgart believe SUNTOUR SUPERBE PRO is the winning choice.





REAR DERAILLEUR
Model: RD-SB00-SSB (Code No.25009921)

Specifications

- ACCUSHIFT PLUS Compatible
- Largest rear sprocket: 26T (24mm dropout) 23T in Full index mode
- Total gear capacity: 26T (Maximum chainring differential 13T)
- Weight: 194g

FRONT DERAILLEUR
Model: FD-SB00-SSH (Code No.29269901)
Clamp-on type
FD-SB00-SSB (Code No.29269921)
Braze-on type

Specifications

- Gear capacity: 16T (12T w/oval chainring)
- Clamp diameter: 1-1/8" (28.6mm)
- Weight: 92g (Clamp-on) 96g (Braze-on)

SHIFT LEVER
Model: SL-SB00-B (Code No.38709911)
Braze-on type
SL-SB00-C (Code No.38709901)
Clamp-on type

Specifications

- Clamp diameter: 1-1/8" (28.6mm)
- Weight: 56g (Braze-on) 81g (Clamp-on)

Standard	Inner Cable		Outer Casing	
	Type	Length (mm)	Type	Length (mm)
Right (Rear)	013	1,300	543	280
Left (Front)	013	800	543	—

SHIFT LEVER
Model: SL-IP00-B (Code No.38119911)
Braze-on type
SL-IP00-C (Code No.38119901)
Clamp-on type

Specifications

- ACCUSHIFT PLUS Compatible
- Clamp diameter: 1-1/8" (28.6mm)
- Weight: 85g (Braze-on) 104g (Clamp-on)

BAR-END CONTROL
Model: SL-BC01-R6R (Code No.31269911)
Right/6-Speed index
SL-BC01-L (Code No.31269921)
Left/Power ratchet

Specifications

- ACCUSHIFT PLUS Compatible
- Clamp diameter: 18.8-22.2mm
- Weight: 188g

Standard	Inner Cable		Outer Casing	
	Type	Length (mm)	Type	Length (mm)
Right (Rear)	029	2,500	751	680x280
Left (Front)	029	2,000	751	680

BAR-END CONTROL
Model: SL-BC00-R7U (Code No.31269913)
Right/7-Speed index
SL-BC00-L (Code No.31269921)
Left/Power ratchet

Specifications

- ACCUSHIFT PLUS Compatible
- Clamp diameter: 18.8-22.2mm
- Weight: 188g

CABLE CASING STOP
Model: OS-410 (Code No.55310211) Right
(Code No.55310212) Left

Specifications

- Mounting position: Down tube (28.6mm)
- Use: Downtube cable casing stop
- Weight: 25g/pr.

BRAKE CALIPER
Model: BA-SB00-SF (Code No.61999029)
Short/Front (Recessed)
BA-SB00-SR (Code No.61999030)
Short/Rear (Recessed)

Specifications

- Shoe adjustment range: 39-49mm (Short reach)
- Weight: 362g/pr. (Recessed type)

BRAKE LEVER
Model: BL-SB10 (Code No.60019901)

Specifications

- Clamp Diameter: 23.8-24.2mm
- Weight: 232g/pr.

Standard	Inner Cable		Outer Casing	
	Type	Length (mm)	Type	Length (mm)
Right	60	1,360	523	1,240
Left	60	680	523	560

BRAKE LEVER
Model: BL-SB00-N (Code No.60009940) Standard
BL-SB00-S (Code No.60009925) Short

Specifications

- Clamp Diameter: 23.8-24.2mm
- Weight: 232g/pr. (Standard)

CRANKSET
Model: CW-SB10
(Code No.51449901) 52T x 42T/L=165.0mm
(Code No.51449905) 52T x 42T/L=167.5mm
(Code No.51449909) 52T x 42T/L=170.0mm
(Code No.51449913) 52T x 42T/L=172.5mm
(Code No.51449917) 52T x 42T/L=175.0mm

Specifications

- Taper size: SUPERBE
- Bolt circle diameter: 130mm
- Available chainrings: 38-43T, 48-53T
- Thread: BC9/16" x 20T (English)
- Weight: 680g (52T x 42T/170.0mm)

BOTTOM BRACKET
Model: BB-SB10-E (Code No.51799921) English
BB-SB10-F (Code No.51799923) French
BB-SB10-I (Code No.51799935) Italian

Specifications

- Ball size: 1/4" x 11 pcs (w/bearing retainer)
- Taper size: SUPERBE
- Thread: BC 1.37" x 24T (English)
*French, Italian thread available
- B.B. Width: 68mm, 70mm
- Weight: 305g

HUB
Model: HB-SB00-F
(Code No.52359209) Front 36H/100mm
(Code No.52359205) Front 32H/100mm
(Code No.52359201) Front 28H/100mm
Model: HB-SB00-R
(Code No.52359251) Rear 36H/126mm
(Code No.52359243) Rear 32H/126mm
(Code No.52359235) Rear 28H/126mm
(Code No.52359257) Rear 36H/130mm
(Code No.52359261) Rear 32H/130mm
(Code No.52359260) Rear 28H/130mm
Model: QR-SB00-F
(Code No.50229125)
Quick release skewer/Front (100mm)
Model: QR-SB00-R
(Code No.50229128)
Quick release skewer/Rear (126mm)
(Code No.50229130)
Quick release skewer/Rear (130mm)

Specifications

- Thread: BC 1.37" x 24T (English)
- "D" dimension: 37mm (126mm, 130mm)
- Weight: 537g/pr. (100/126mm)

PEDAL
Model: PL-SB00 (Code No.53279931)

Specifications

- Thread: BC 9/16" x 20T (English)
- Weight: 290g/pr.

CLIPLESS PEDAL *NEW
Model: PL-TM00 (Code No.53109901)

Specifications

- Features: Step-in mechanism
- Type: Road
- Thread: BC 9/16" x 20T (English)
- Weight: 477g/pr.

HEAD SET
Model: HS-SB00-E (Code No.50149901) English
HS-SB00-F (Code No.50149907) French
HS-SB00-I (Code No.50149913) Italian

Specifications

- Type: Road & Track
- Ball size: 5/32" x 22 pcs (w/Bearing retainer)
- Thread: BC 1" x 24T (English)
- Weight: 119g

FREEWHEEL *NEW
Model: FW-WT10-S7U
(Code No.17079802) 7-Speed, Top/12T
(Code No.17079803) 7-Speed, Top/13T

Specifications

- ACCUSHIFT PLUS Compatible
- Thread: BC 1.37" x 24T (English)
- Compatible chain: 1/2" x 3/32" (Narrow size)
- Compatible "D" dimension: 37mm
- Standard gear ratio (Weight):
12x13x14x15x17x19x21T (375g)
12x13x14x16x18x20x23T (400g)
13x14x15x16x17x19x21T (395g)
13x14x15x17x19x21x23T (425g)

FREEWHEEL *NEW
Model: FW-WT10-S6R
(Code No.17069801) 6-Speed

Specifications

- ACCUSHIFT PLUS Compatible
- Thread: BC 1.37" x 24T (English)
- Compatible chain: 1/2" x 3/32"
- Compatible "D" dimension: 37mm
- Standard gear ratio (Weight):
13x14x15x17x19x21T (355g)

SEAT POST
Model: SP-SB00-S
(Code No.53629661) 26.8mm/L=200mm
(Code No.53629667) 27.0mm/L=200mm
(Code No.53629673) 27.2mm/L=200mm
Model: SP-SB00-L
(Code No.53629664) 26.8mm/L=250mm
(Code No.53629670) 27.0mm/L=250mm
(Code No.53629676) 27.2mm/L=250mm

Specifications

- Diameter: 25.0mm, 26.6mm, 26.8mm, 27.0mm, 27.2mm
- Saddle angle adjustment range: 22-degrees
- Saddle rail diameter: 7-8mm
- Weight: 250g (26.8mm/L=200mm)

CHAIN *NEW
Model: CH-AP00
(Code No.50650116) Silver & silver

Specifications

- ACCUSHIFT PLUS Compatible
- Features: Dai-hard treated pin
- Size: 1/2" x 3/32" (Narrow size)
- Pin width: 7.3mm
- Weight: 326g (116 links)



SUNTOUR *Sprint*

Our proven SUNTOUR Sprint components have gotten faster and smoother with the AccuShift Plus system. Borrowing heavily from the Superbe group in function specifics, design and materials, these race-ready parts shine with performance details.



Clipless pedal available on complete bicycles from bicycle manufacturers and custom builders only.



**AP CHAIN
AP COGS
CARTRIDGE BEARING**



REAR DERAILLEUR
Model: RD-SP10-SSB (Code No.25059921)
Specifications
• **ACCUSHIFT PLUS** Compatible
• **Largest rear sprocket:**
26T (24mm dropout)
23T in Full index mode
• **Total gear capacity:**
26T (Maximum chainring differential 13T)
• **Weight:** 204g

FRONT DERAILLEUR
Model: FD-3900-SSH (Code No. 29289903)
Clamp-on type
FD-SP00-SSB (Code No.29289931)
Braze-on type
Specifications
• **Gear capacity:** 18T (14T w/oval chainring)
• **Clamp diameter:** 1-1/8" (28.6mm)
• **Weight:** 97g (Clamp-on)
82g (Braze-on)

SHIFT LEVER
Model: SL-IP00-B (Code No.38119911)
Braze-on type
SL-IP00-C (Code No.38119901)
Clamp-on type
Specifications
• **ACCUSHIFT PLUS** Compatible
• **Clamp diameter:** 1-1/8" (28.6mm)
• **Weight:** 85g (Braze-on)
104g (Clamp-on)

Standard	Inner Cable		Outer Casing	
	Type	Length (mm)	Type	Length (mm)
Right (Rear)	013	1,300	543	280
Left (Front)	013	800	543	—

SHIFT LEVER
Model: LD-4850 (Code No.31759911)
Braze-on type
LD-4800 (Code No.31759901)
Clamp-on type
Specifications
• **Clamp diameter:** 1-1/8" (28.6mm)
• **Weight:** 56g (Braze-on)
80g (Clamp-on)

BRAKE LEVER
Model: BL-SP10 (Code No.60069901)
Specifications
• **Features:** Balanced Response System
• **Clamp Diameter:** 23.8-24.2mm
• **Weight:** 256g/pr.

Standard	Inner Cable		Outer Casing	
	Type	Length (mm)	Type	Length (mm)
Right	60	1,360	543	1,240
Left	60	680	543	560

BRAKE CALIPER
Model: BA-SP00-SF (Code No.62089011)
Short/Front (Recessed)
BA-SP00-SR (Code No.62089013)
Short/Rear (Recessed)
Specifications
• **Features:** Balanced Response System
• **Shoe adjustment range:** 39-49mm
• **Weight:** 328g/pr. (Recessed type)

CRANKSET
Model: CW-7500
(Code No.51639901) 52T×42T/L=165.0mm
(Code No.51639905) 52T×42T/L=167.5mm
(Code No.51639909) 52T×42T/L=170.0mm
(Code No.51639913) 52T×42T/L=172.5mm
(Code No.51639917) 52T×42T/L=175.0mm
Specifications
• **Taper size:** SUPERBE
• **Bolt circle diameter:** 130mm
• **Available chainrings:** 38-43T, 48-53T
• **Thread:** BC 9/16"×20T (English)
• **Weight:** 680g (52T×42T/170.0mm)

BOTTOM BRACKET
Model:
BB-500-E (Code No.51789901) English
BB-500-F (Code No.51789903) French
BB-500-I (Code No.51789915) Italian
Specifications
• **Ball size:** 1/4"×11 pcs (w/bearing retainer)
• **Taper size:** SUPERBE
• **Thread:** BC 1.37"×24T (English)
• **B.B. Width:** 68mm, 70mm
• **Weight:** 298g

PEDAL
Model: PL-5600 (Code No.53409901)
Specifications
• **Type:** Road Type
• **Thread:** BC 9/16"×20T (English)
• **Weight:** 360g/pr.

CLIPLESS PEDAL *NEW
Model: PL-TM00 (Code No.53109901)
Specifications
• **Features:** Step-in mechanism
• **Type:** Road
• **Thread:** BC 9/16"×20T (English)
• **Weight:** 477g/pr.

HUB
Model: HB-SP00-F
(Code No.52059041) Front 36H/100mm
(Code No.52059037) Front 32H/100mm
(Code No.52059033) Front 28H/100mm
Model: QR-XC00-F
(Code No.50249141)
Front quick release skewer
Model: HB-SP00-R
(Code No.52059073) Rear 36H/126mm
(Code No.52059065) Rear 32H/126mm
(Code No.52059057) Rear 28H/126mm
Model: QR-XC00-R
(Code No.50249147)
Rear quick release skewer
Specifications
• **Thread:** BC 1.37"×24T (English)
• **"D" dimension:** 37mm (126mm, 130mm)
• **Weight:** 557g/pr. (100/126mm)

FREEWHEEL *NEW
Model: FW-WT10-S7U
(Code No.17079802) 7-Speed, Top/12T
Model: FW-WT10-S7U
(Code No.17079803) 7-Speed, Top/13T
Specifications
• **ACCUSHIFT PLUS** Compatible
• **Thread:** BC 1.37"×24T (English)
• **Compatible chain:** 1/2"×3/32" (Narrow size)
• **Compatible hub "D" dimension:** 37mm
• **Standard gear ratio (Weight):**
12×13×14×15×16×17×19×21T (375g)
12×13×14×16×18×20×23T (400g)
13×14×15×16×17×19×21T (395g)
13×14×15×17×19×21×23T (425g)

FREEWHEEL *NEW
Model: FW-WT10-S6R
(Code No.17069801) 6-Speed
Specifications
• **ACCUSHIFT PLUS** Compatible
• **Thread:** BC 1.37"×24T (English)
• **Compatible chain:** 1/2"×3/32"
• **Compatible hub "D" dimension:** 37mm
• **Standard gear ratio (Weight):**
13×14×15×17×19×21T (355g)

HEAD SET
Model:
HS-SA00-E (Code No.50179921) English
HS-SA00-F (Code No.50179927) French
HS-SA00-I (Code No.50179933) Italian
Specifications
• **Type:** Road & Track
• **Ball size:** 5/32"×22 pcs (w/Bearing retainer)
• **Thread:** BC 1"×24T (English)
• **Weight:** 125g

SEAT POST
Model: SP-SU00-S
(Code No.53659931) L=200mm/26.8mm
(Code No.53659937) L=200mm/27.0mm
(Code No.53659943) L=200mm/27.2mm
Specifications
• **Diameter:** 26.8mm, 27.0mm, 27.2mm
• **Saddle angle adjustment range:**
26-degrees
• **Saddle rail diameter:** 7-8mm
• **Weight:** 280g/L=200mm

CHAIN *NEW
Model: CH-AP00
(Code No.50650116) Silver & silver
Specifications
• **ACCUSHIFT PLUS** Compatible
• **Features:** Dai-hard treated pin
• **Size:** 1/2"×3/32" (Narrow size)
• **Pin width:** 7.3mm
• **Weight:** 326g (116 links)



WHEEL COVER PE-1500



SUNTOUR GPX FEATURES

Smooth, light, compact, durable and beautiful. SUNTOUR GPX is improved for 1990 with AccuShift Plus. Smooth is now smoother. Our astonishingly popular GPX group is the result of an integrated effort by engineers and designers to bring you the best looking and best performing example of form follows function.



POWERING
AP CHAIN
AP COGS
AP SHIFTER
COMMAND

Clipless pedal available on complete bicycles from bicycle manufacturers and custom builders only.





SHIFT LEVER

Model: SL-GP10-B
(Code No.32309841) Braze-on type
Model: SL-GP10-C
(Code No.32309941) Clamp-on type

Specifications

- ACCUSHIFT PLUS Compatible
- Clamp diameter: 1-1/8" (28.6mm)
- Weight: 80g (Braze-on)
100g (Clamp-on)

Standard	Inner Cable		Outer Casing	
	Type	Length (mm)	Type	Length (mm)
Right (Rear)	029	1,300	771	280
Left (Front)	029	800	771	—

COMMAND SHIFTER *NEW

Model: SL-CD00-R7U
(Code No.32209571) Right/7-Speed index
Model: SL-CD00-L
(Code No.32209701) Left/Power ratchet

Specifications

- ACCUSHIFT PLUS Compatible
- Mounting position: Handlebar
- Clamp diameter: 23.8~24.2mm
- Weight: 185g/pr.

Standard	Inner Cable		Outer Casing	
	Type	Length (mm)	Type	Length (mm)
Right (Rear)	029	2,000	751	600-280
Left (Front)	029	1,500	751	600

COMMAND SHIFTER *NEW

Model: SL-CD00-R6R
(Code No.32209561) Right/6-Speed index
Model: SL-CD00-L
(Code No.32209701) Left/Power ratchet

Specifications

- ACCUSHIFT PLUS Compatible
- Mounting position: Handlebar
- Clamp diameter: 23.8~24.2mm
- Weight: 185g/pr.

BRAKE CALIPER

Model: BA-GP00-SF (Code No.62069009)
Short/Front (Recessed)
BA-GP00-SR (Code No.62069011)
Short/Rear (Recessed)

Specifications

- Features: Balanced Response System
- Shoe adjustment range: 39~49mm
- Weight: 370g/pr. (Recessed type)

BRAKE LEVER

Model: BL-GP00 (Code No.60029001)R
(Code No.60029021) L

Specifications

- Features: Balanced Response System
- Clamp Diameter: 23.8~24.2mm
- Weight: 260g/pr.

Standard	Inner Cable		Outer Casing	
	Type	Length (mm)	Type	Length (mm)
Right (Rear)	60	1,360	523	1,240
Left (Front)	60	680	523	560

REAR DERAILLEUR

Model: RD-GP00-SSB (Code No.24169921)

Specifications

- ACCUSHIFT PLUS Compatible
- Largest rear sprocket: 26T (24mm dropout)
23T in Full index mode
- Total gear capacity: 26T (Maximum chainring differential: 13T)
- Weight: 215g

FRONT DERAILLEUR

Model: FD-GP00-SSH
(Code No.29809901) Clamp-on type
Model: FD-GP00-SSB
(Code No.29809921) Braze-on type

Specifications

- Gear capacity: 16T (12T w/oval chainring)
- Clamp diameter: 1-1/8" (28.6mm)
- Weight: 99g (Clamp-on)
96g (Braze-on)



CRANKSET *NEW

Model: CW-GP10
(Code No.51649821) 52T×42T/L=165.0mm
(Code No.51649823) 52T×42T/L=167.5mm
(Code No.51649825) 52T×42T/L=170.0mm
(Code No.51649827) 52T×42T/L=172.5mm
(Code No.51649829) 52T×42T/L=175.0mm

Specifications

- Features: Powe Ring (52T×42T only)
- Taper size: VX
- Bolt circle diameter: 130mm
- Available chainrings: 38, 40, 42, 50, 52, 53T
- Thread: BC 9/16"×20T (English)
- Weight: 686g (52T×42T/170.0mm)

BOTTOM BRACKET *NEW

Model:
BB-GP10-E (Code No.51869902) English
BB-GP10-F (Code No.51869903) French
BB-GP10-I (Code No.51869915) Italian

Specifications

- Ball size: 1/4"×9 pcs (w/bearing retainer)
- Taper size: VX
- Thread: BC 1.37"×24T (English)
*French, Italian thread available
- B.B. Width: 68mm, 70mm
- Weight: 321g

PEDAL

Model: PL-GP00 (Code No.53429901)

Specifications

- Type: Road
- Thread: BC 9/16"×20T (English)
- Weight: 360g/pr.

CLIPLESS PEDAL *NEW

Model: PL-TM00 (Code No.53109901)

Specifications

- Features: Step-in mechanism
- Type: Road
- Thread: BC 9/16"×20T (English)
- Weight: 477g/pr.

CHAIN *NEW

Model: CH-AP10
(Code No.50670116) Black & silver

Specifications

- ACCUSHIFT PLUS Compatible
- Size: 1/2"×3/32" (Narrow size)
- Pin width: 7.3mm
- Weight: 326g (116 links)

HUB

Model: HB-GP00-F
(Code No.52619007) Front 36H/100mm
(Code No.52619003) Front 32H/100mm
Model: QR-GP00-F
(Code No.50249172)
Quick release skewer/Front (100mm)

Specifications

- Model: HB-GP00-R
(Code No.52619027) Rear 36H/126mm
(Code No.52619023) Rear 32H/126mm
Model: QR-GP00-R
(Code No.50249177)
Quick release skewer/Rear (126mm)

Specifications

- Thread: BC 1.37"×24T (English)
- "D" dimension: 37mm
- Weight: 539g/pr. (36H, 100/126mm)

FREEHUB *NEW

Model: FH-GP00-7U
(Code No.47539934) 36H/126mm, 7-Speed
(Code No.47539928) 32H/126mm, 7-Speed
(Code No.47539936) 36H/130mm, 7-Speed
(Code No.47539930) 32H/130mm, 7-Speed
Model: QR-GP00-R
(Code No.50249177)
Quick release skewer/Rear (126mm)
(Code No.50249179)
Quick release skewer/Rear (130mm)
Model: CS-AP00-S7U
(Code No.47179803)
Cassette cogs, 7-Speed/silver

Specifications

- ACCUSHIFT PLUS Compatible
- Weight: 448g (36H/126mm)

FREEHUB *NEW

Model: FH-GP00-6R
(Code No.47539914) 36H/126mm, 6-Speed
(Code No.47539908) 32H/126mm, 6-Speed
(Code No.47539916) 36H/130mm, 6-Speed
(Code No.47539930) 32H/130mm, 6-Speed
Model: QR-GP00-R
(Code No.50249177)
Quick release skewer/Rear (126mm)
(Code No.50249179)
Quick release skewer/Rear (130mm)
Model: CS-AP00-S6R
(Code No.47169801)
Cassette cogs, 6-Speed/silver

Specifications

- ACCUSHIFT PLUS Compatible
- Weight: 448g (36H/126mm)

FREEWHEEL *NEW

Model: FW-AL10-S7U
(Code No.15079803) 7-Speed

Specifications

- ACCUSHIFT PLUS Compatible
- Thread: BC 1.37"×24T (English)*
- Compatible chain: 1/2"×3/32" (Narrow size)
- Compatible hub "D" dimension: 37mm
- Standard gear ratio (Weight):
13×14×15×16×17×18×21T (380g)
13×14×15×17×19×21×23T (410g)

FREEWHEEL *NEW

Model: FW-AL10-S6R
(Code No.15069801) 6-Speed

Specifications

- ACCUSHIFT PLUS Compatible
- Thread: BC 1.37"×24T (English)
- Compatible chain: 1/2"×3/32"
- Compatible hub "D" dimension: 37mm
- Standard gear ratio (Weight):
13×14×15×17×19×21T (360g)

HEAD SET

Model:
HS-GP00-E (Code No.50189903) English
HS-GP00-F (Code No.50189907) French
HS-GP00-I (Code No.50189911) Italian

Specifications

- Type: Road & Track
- Ball size: 5/32"×22 pcs (w/Bearing retainer)
- Thread: BC 1"×24T (English)
- Weight: 125g

SEAT POST

Model: SP-SU00-S
(Code No.53659931) L=200mm/26.8mm
(Code No.53659937) L=200mm/27.0mm
(Code No.53659943) L=200mm/27.2mm

Specifications

- Diameter: 26.8mm, 27.0mm, 27.2mm
- Saddle angle adjustment range:
26-degrees
- Saddle rail diameter: 7~8mm
- Weight: 280g/L=200mm



'90 NEW COMPONENTS SUNTOUR RADIUS

Following close on the wheels of the popular and victorious SUNTOUR GPX group, the new RADIUS ensemble sports the same ergonomic and compact design solutions that made SUNTOUR GPX the lightweight winner in 1989. The AccuShift Plus system takes the guesswork out of shifting, allowing you to concentrate on the ride, whether it's around the block or down the road.

POWERING
AP CHAIN
AP COGS
AP SHIFTER
COMMAND



REAR DERAILLEUR

Model: RD-RA00-SSB (Code No.23359921)

Specifications

- ACCUSHIFT PLUS Compatible
- Largest rear cog: 28T (26mm dropout) 24T in Full index mode
- Total gear capacity: 28T (Maximum chainring differential 13T)
- Weight: 257g

FRONT DERAILLEUR

Model: FD-RA00-SSH (Code No.29009911)
Clamp-on type
FD-RA00-SSB (Code No.29009921)
Braze-on type

Specifications

- Gear capacity: 16T (12T w/oval chainring)
- Clamp diameter: 1-1/8" (28.6mm) 1-1/4" (31.8mm)
- Weight: 99g (Clamp-on) 96g (Braze-on)

SHIFT LEVER

Model: SL-RA00-B (Code No.32409841)
Braze-on type
SL-RA00-C (Code No.32409941)
Clamp-on type

Specifications

- ACCUSHIFT PLUS Compatible
- Clamp diameter: 1-1/8" (28.6mm)
- Weight: 81g (Braze-on) 101g (Clamp-on)

Standard	Inner Cable		Outer Casing	
	Type	Length (mm)	Type	Length (mm)
Right (Rear)	029	1,300	771	280
Left (Front)	029	800	771	—

COMMAND SHIFTER

Model: SL-CD00-R7U (Code No.32209571)
Right/7-Speed index
SL-CD00-L (Code No.32209701)
Left/Power ratchet

Specifications

- ACCUSHIFT PLUS Compatible
- Mounting position: Handlebar
- Clamp diameter: 23.8-24.2mm
- Weight: 185g/pr.

Standard	Inner Cable		Outer Casing	
	Type	Length (mm)	Type	Length (mm)
Right (Rear)	029	2,000	751	600x280
Left (Front)	029	2,000	751	600

COMMAND SHIFTER

Model: SL-CD00-R6R (Code No.32209561)
Right/6-Speed index
SL-CD00-L (Code No.32209701)
Left/Power ratchet

Specifications

- ACCUSHIFT PLUS Compatible
- Mounting position: Handlebar
- Clamp diameter: 23.8-24.2mm
- Weight: 185g/pr.

BRAKE LEVER

Model: BL-RA00-S
(Code No.60039903) Short
Model: BL-RA00
(Code No.60039901) Standard

Specifications

- Features: Balanced Response System
- Clamp Diameter: 23.8-24.2mm
- Weight: 228g/pr.

Standard	Inner Cable		Outer Casing	
	Type	Length (mm)	Type	Length (mm)
Right (Rear)	60	1,360	523	1,240
Left (Front)	60	680	523	560

BRAKE CALIPER

Model: BA-RA00-SF (Code No.62049909)
Short/Front (Recessed)
BA-RA00-SR (Code No.62049911)
Short/Rear (Recessed)

Specifications

- Features: Balanced Response System
- Shoe adjustment range: 40-52mm
- Weight: 283g/pr. (Recessed type)

CRANKSET

Model: CW-RA00
(Code No.51609931) 52T x 42T/L = 165.0mm
(Code No.51609935) 52T x 42T/L = 170.0mm
(Code No.51609939) 52T x 42T/L = 175.0mm

Specifications

- Feature: PowerRing (52T x 42T only)
- Taper size: VX
- Bolt circle diameter: 130mm
- Available chainrings: 38-42T, 50-53T
- Thread: BC 9/16" x 20T (English)
- Weight: 686g (52T x 42T/170.0mm)

BOTTOM BRACKET

Model: BB-RA00-E
(Code No.51019901) English

Specifications

- Ball size: 1/4" x 9 pcs (w/bearing retainer)
- Taper size: VX
- Thread: BC 1.37" x 24T (English)
*French, Italian thread available
- B.B. Width: 68mm, 70mm
- Weight: 330g

PEDAL

Model: PL-RA00 (Code No.53069901)

Specifications

- Type: Road
- Thread: BC 9/16" x 20T (English)
- Weight: 261g/pr.

HUB

Model: HB-RA00-F
(Code No.52839131) Front 36H/100mm
(Code No.52839121) Front 32H/100mm
Model: QR-RA00-F
(Code No.50249192)
Quick release skewer/Front (100mm)
Model: HB-RA00-R
(Code No.52839234) Rear 36H/126mm
(Code No.52839224) Rear 32H/126mm
Model: QR-RA00-R
(Code No.50249196)
Quick release skewer/Rear (126mm)

Specifications

- Thread: BC 1.37" x 24T (English)
- "D" dimension: 37mm (126mm)
- Weight: 571 g/pr. (36H, 100/126mm)

FREEHUB

Model: FH-AT00-7U
(Code No.47669934) 36H/126mm, 7-Speed
(Code No.47669924) 32H/126mm, 7-Speed
(Code No.47669936) 36H/130mm, 7-Speed
Model: QR-RA00-R
(Code No.50249196)
Quick release skewer/Rear (126mm)
(Code No.50249197)
Quick release skewer/Rear (130mm)
Model: CS-AP00-S7U
(Code No.47179803)
Cassette cogs, 7-Speed/silver

Specifications

- ACCUSHIFT PLUS Compatible
- Weight: 468g (36H/126mm)

FREEHUB

Model: FH-AT00-6R
(Code No.47669914) 36H/126mm, 6-Speed
(Code No.47669904) 32H/126mm, 6-Speed
(Code No.47669916) 36H/130mm, 6-Speed
(Code No.47669906) 32H/130mm, 6-Speed
Model: QR-RA00-R
(Code No.50249196)
Quick release skewer/Rear (126mm)
(Code No.50249197)
Quick release skewer/Rear (130mm)
Model: CS-AP00-S6R
(Code No.47169801)
Cassette cogs, 6-Speed/silver

Specifications

- ACCUSHIFT PLUS Compatible
- Weight: 468g (36H/126mm)

FREEWHEEL

Model: FW-AL10-S7U
(Code No.15079803) 7-Speed

Specifications

- ACCUSHIFT PLUS Compatible
- Thread: BC 1.37" x 24T (English)
- Compatible chain: 1/2" x 3/32" (Narrow size)
- Compatible hub "D" dimension: 37mm
- Standard gear ratio (Weight):
13x14x15x16x17x19x21T (380g)
13x14x15x17x19x21x23T (410g)

FREEWHEEL

Model: FW-AL10-S6R
(Code No.15069801) 6-Speed

Specifications

- ACCUSHIFT PLUS Compatible
- Thread: BC 1.37" x 24T (English)
- Compatible chain: 1/2" x 3/32"
- Compatible hub "D" dimension: 37mm
- Standard gear ratio (Weight):
13x14x15x17x19x21T (360g)

CHAIN

Model: CH-AP10
(Code No.50670116) Black & silver

Specifications

- ACCUSHIFT PLUS Compatible
- Size: 1/2" x 3/32" (Narrow size)
- Pin width: 7.3mm
- Weight: 326g (116 links)

'90 NEW COMPONENTS

SUNTOUR EDGE



POWERING
AP CHAIN
AP COGS
AP SHIFTER
COMMAND

REAR DERAILEUR
Model: RD-ED00-SSB (Code No.23449921)

FRONT DERAILEUR
Model: FD-ED00-SSH (Code No.29029911)
Clamp-on type

SHIFT LEVER
Model: SL-ED00-B7U (Code No.32509841)
7-Speed/Braze-on type
SL-ED00-C7U (Code No.32509941)
7-Speed/Clamp-on type
SL-ED00-B6R (Code No.32509821)
6-Speed/Braze-on type
SL-ED00-C6R (Code No.32509941)
6-Speed/Clamp-on type

COMMAND SHIFTER
Model: SL-CD00-R7U (Code No.32209571)
Right/7-Speed index
Model: SL-CD00-R6R (Code No.32209561)
Right/6-Speed index
Model: SL-CD00-L (Code No.32209701)
Left/Ratchet power

BRAKE CALIPER
Model: BA-ED00-SF (Code No.62149001)
Short/Front (Recessed)
BA-ED00-SR (Code No.62149003)
Short/Rear (Recessed)

BRAKE LEVER
Model: BL-ED00
(Code No.60139901)

CRANKSET
Model: CW-ED00
(Code No.51729831) 52T×42T/L=165.0mm
(Code No.51729835) 52T×42T/L=170.0mm
(Code No.51729839) 52T×42T/L=175.0mm

BOTTOM BRACKET
Model: BB-RA00-E (Code No.51019901)
*English, French, Italian thread available.

PEDAL
Model: PL-ED00 (Code No.53079901)

HUB *NEW
Model: HB-RA00-F
(Code No.52839131) Front 36H/100mm
(Code No.52839121) Front 32H/100mm
Model: QR-RA00-F
(Code No.50249192)
Quick release skewer/Front (100mm)
Model: HB-RA00-R
(Code No.52839234) Rear 36H/126mm
(Code No.52839224) Rear 32H/126mm
Model: QR-RA00-R
(Code No.50249196)
Quick release skewer/Rear (126mm)

FREEWHEEL
Model: FW-AL10-K7U
(Code No.15079703) 7-Speed

FREEWHEEL
Model: FW-AL10-K6R
(Code No.15069701) 6-Speed

FREEHUB
Model: FH-AT00-7U
(Code No.47669934) 36H/126mm, 7-Speed
(Code No.47669924) 32H/126mm, 7-Speed
Model: QR-RA00-R
(Code No.50249196)
Quick release skewer/Rear (126mm)
Model: CS-AP00-K7U
(Code No.47179703)
Cassette cogs, 7-Speed/silver

FREEHUB
Model: FH-AT00-6R
(Code No.47669914) 36H/126mm, 6-Speed
(Code No.47669904) 32H/126mm, 6-Speed
Model: QR-RA00-R
(Code No.50249196)
Quick release skewer/Rear (126mm)
Model: CS-AP00-K6R
(Code No.47169701)
Cassette cogs, 6-Speed/silver

CHAIN
Model: CH-AP20 (Code No.50690116)

'90 NEW COMPONENTS

SUNTOUR BLAZE



POWERING
AP CHAIN
AP COGS
AP SHIFTER
COMMAND

REAR DERAILEUR
Model: RD-BE00-SSB (Code No.23549921)

FRONT DERAILEUR
Model: FD-BE00-SSH (Code No.29059911)
Clamp-on type

SHIFT LEVER
Model:
SL-BE00-B7U (Code No.32609841)
7-Speed/Braze-on type
SL-BE00-C7U (Code No.32609941)
7-Speed/Clamp-on type
SL-BE00-B6R (Code No.32609821)
6-Speed/Braze-on type
SL-BE00-C6R (Code No.32609921)
6-Speed/Clamp-on type
SL-BE00-CP7U (Code No.34109941)
7-Speed/Handlebar-stem Clamp-on
SL-BE00-CP6R (Code No.34109921)
6-Speed/Handlebar-stem Clamp-on

COMMAND SHIFTER
Model: SL-CD00-R7U
(Code No.32209571) Right/7-Speed index
Model: SL-CD00-R6R
(Code No.32209561) Right/6-Speed index
Model: SL-CD00-L
(Code No.32209701) Left/Ratchet power

BRAKE CALIPER
Model: BA-BE00-SF (Code No.62159001)
Short/Front (Recessed)
BA-BE00-SR (Code No.62159003)
Short/Rear (Recessed)

BRAKE LEVER
Model: BL-BE00
(Code No.60149901)

CRANKSET
Model: CW-BE00
(Code No.51719831) 52T×42T/L=165.0mm
(Code No.51719835) 52T×42T/L=170.0mm
(Code No.51719839) 52T×42T/L=175.0mm

BOTTOM BRACKET
Model: BB-BE00-E (Code No.51029901)
*English, French, Italian thread available.

PEDAL
Model: PL-BE00 (Code No.53089901)

HUB
Model: HB-BE00-F
(Code No.52859131) Front 36H/100mm
Model: QR-RA00-F
(Code No.50249192)
Quick release skewer/Front (100mm)
Model: HB-BE00-R
(Code No.52859234) Rear 36H/126mm
Model: QR-RA00-R
(Code No.50249196)
Quick release skewer/Rear (126mm)

FREEWHEEL
Model: FW-AL10-K7U (Code No.15079703)
7-Speed

FREEWHEEL
Model: FW-AL10-K6R (Code No.15069701)
6-Speed

CHAIN
Model: CH-AP20 (Code No.50690116)

CHAIN
Model: CH-AP50 (Code No.50700116)

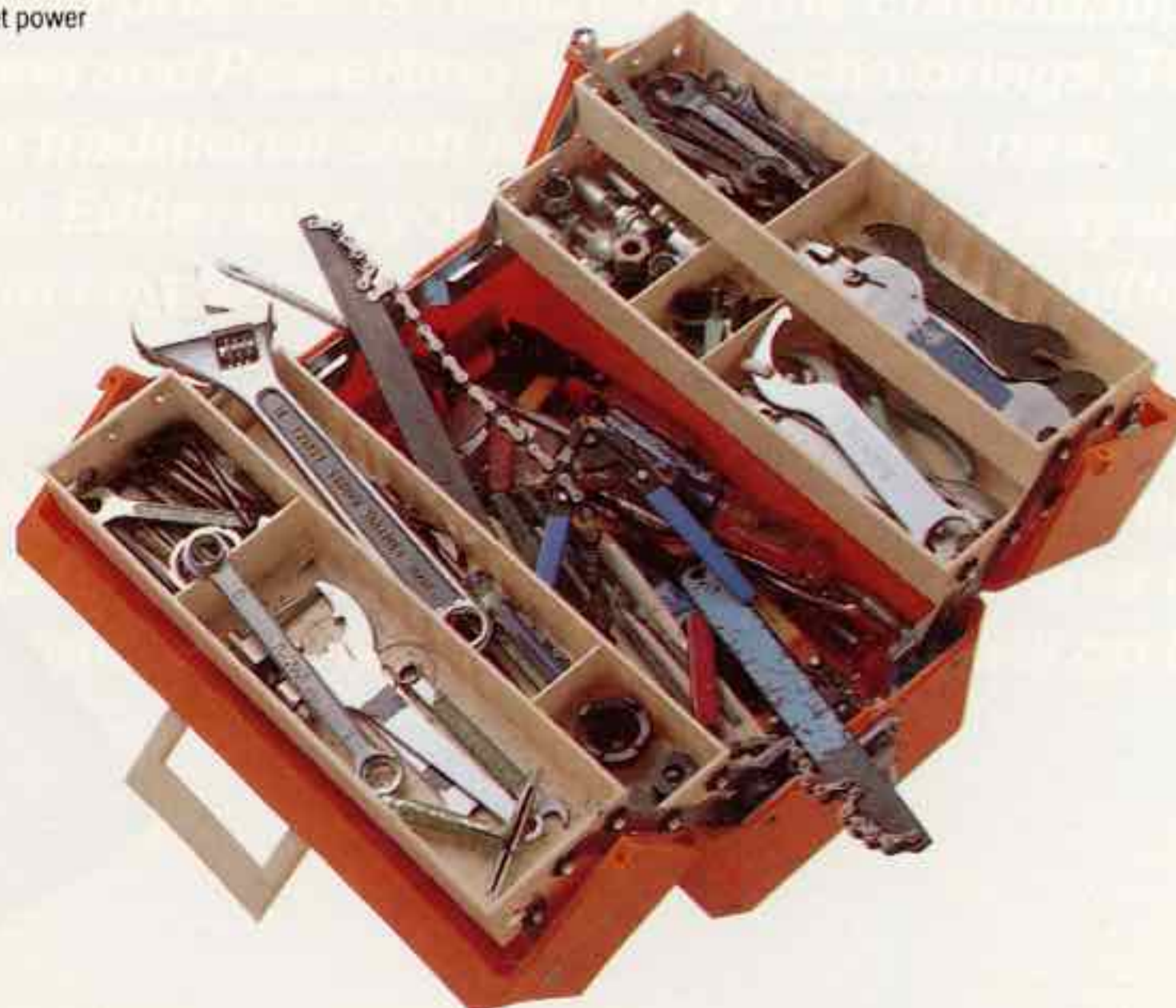

Lighter, Stronger, Smoother

AC SHIFT PLUS

'90 NEW COMPONENTS SUNTOUR VX



REAR DERAILLEUR
Model: RD-VX00-SSB (Code No.23649921)

REAR DERAILLEUR
Model: RD-VX10-SSB (Code No.23659921)

FRONT DERAILLEUR
Model: FD-VX00-SSH
(Code No.29069911) Clamp-on type

SHIFT LEVER
Model:
SL-VX00-B7U (Code No.32709841)
7-Speed/Braze-on type
SL-VX00-C7U (Code No.32709941)
7-Speed/Clamp-on type
SL-VX00-B6R (Code No.32709821)
6-Speed/Braze-on type
SL-VX00-C6R (Code No.32709941)
6-Speed/Clamp-on type
SL-VX00-CP7U (Code No.34209941)
7-Speed/Handlebar-stem Clamp-on
SL-VX00-CP6R (Code No.34209921)
6-Speed/Handlebar-stem Clamp-on

BRAKE CALIPER
Model: BA-VX00-NF (Code No.62169901)
Short/Front (Recessed)
BA-VX00-NR (Code No.62169903)
Short/Rear (Recessed)

BRAKE LEVER
Model: BL-VX00
(Code No.60159901)

CRANKSET
Model: CW-VX00
(Code No.51389901) 52T×42T/L=165.0mm
(Code No.51389903) 52T×42T/L=170.0mm

BOTTOM BRACKET
Model: BB-VX00-E (Code No.51039901)
* English, French, Italian thread available.

PEDAL
Model: PL-VX00 (Code No.53169901)

FREEWHEEL
Model: FW-AL10-K7U
(Code No.15079703) 7-Speed

FREEWHEEL
Model: FW-AL10-K6R
(Code No.15069701) 6-Speed

CHAIN
Model: CH-AP20 (Code No.50690116)

CHAIN
Model: CH-AP50 (Code No.50700116)

'90 NEW COMPONENTS SUNTOUR AC 2000



REAR DERAILLEUR
Model: RD-A200-SSB (Code No.23749921)

FRONT DERAILLEUR
Model: FD-A200-SSH
(Code No.29119911) Clamp-on type

SHIFT LEVER
Model:
SL-A200-B6R (Code No.32809821)
6-Speed, Braze-on type
SL-A200-C6R (Code No.32809921)
6-Speed, Clamp-on type
SL-A200-CP6R (Code No.34309921)
6-Speed, Handlebar-stem Clamp-on
SL-1500-CP (Code No.34899931)
6-Speed, Handlebar-stem Clamp-on

FREEWHEEL
Model: FW-AL10-K6R
(Code No.15069701) 6-Speed

CHAIN
Model: CH-AP20 (Code No.50690116)

CHAIN
Model: CH-AP50 (Code No.50700116)

'90 NEW COMPONENTS SUNTOUR AC 1000



REAR DERAILLEUR
Model: RD-A100-SSB (Code No.23899921)

FRONT DERAILLEUR
Model: FD-RT10-SSH
(Code No.29719911) Clamp-on type

SHIFT LEVER
Model:
SL-1500-CP (Code No.38899931)
6-Speed, Handlebar-stem Clamp-on
SL-RT10-CP (Code No.38899911)
6-Speed, Handlebar-stem Clamp-on
LD-286-C (Code No.30359911)
6-Speed, Handlebar-stem Clamp-on



GEAR BAG PE-3200

SUNTOUR SUPERBE PRO TRACK



CRANKSET

Model: CW-6000 (Code No.51479901)
49T/L=165mm

Specifications

- Taper size: SUPERBE
- Bolt circle diameter: 144mm
- Available chainrings: 44T-54T
- Thread: BC 1.37" x 24T (English)
- Weight: 625g (49T/L=165mm)

PEDAL

Model: PL-2000 (Code No.53289931)

Specifications

- Thread: BC 9/16" x 20T (English)
- Weight: 278g/pr.

HUB

Model: BH-1600
(Code No.52369439) Front, 32H/100mm
(Code No.52369435) Front, 28H/100mm
(Code No.52369465) Rear, 32H/120mm
(Code No.52369461) Rear, 28H/120mm
Model: BH-1800
(Code No.52369275) Front, 36H/100mm
(Code No.52369571) Rear, 36H/120mm

Specifications

- Thread: BC 1.37" x 24T (English)
- Weight: 545g/pr.

TRACK COG

Model: HC-100

- (Code No.11720102) 12T, 1/8"
- (Code No.11720112) 12T, 3/32"
- (Code No.11730102) 13T, 1/8"
- (Code No.11730112) 13T, 3/32"
- (Code No.11740102) 14T, 1/8"
- (Code No.11740112) 14T, 3/32"
- (Code No.11750102) 15T, 1/8"
- (Code No.11750112) 15T, 3/32"
- (Code No.11760102) 16T, 1/8"
- (Code No.11760112) 16T, 3/32"
- (Code No.11770102) 17T, 1/8"
- (Code No.11770112) 17T, 3/32"

Specifications

- Compatible chain: 1/2" x 1/8"
1/2" x 3/32"
- Weight: 41g (14T)

TRACK LOCK RING

Model: HC-900

(Code No.11727202) For 12T only
(Code No.11737202) For 13T-17T

Specifications

- Weight: 21g (12T)



SUNTOUR COMPONENT SYSTEM CHART

XCPRO

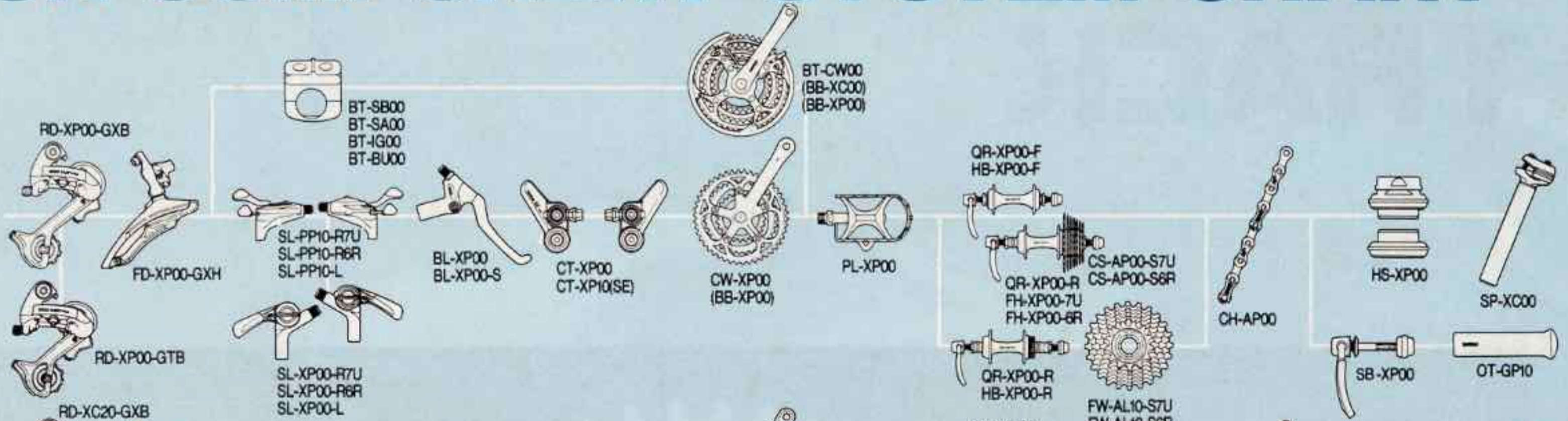

XCCOMP

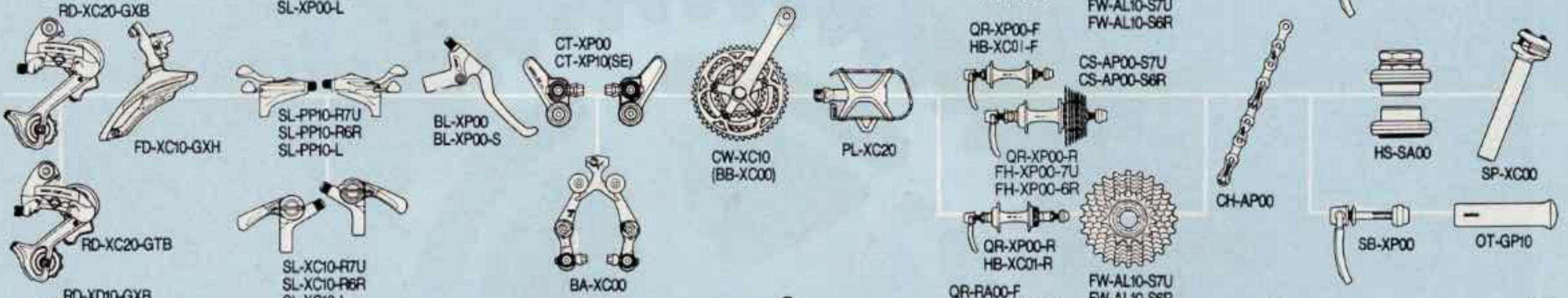

XCD

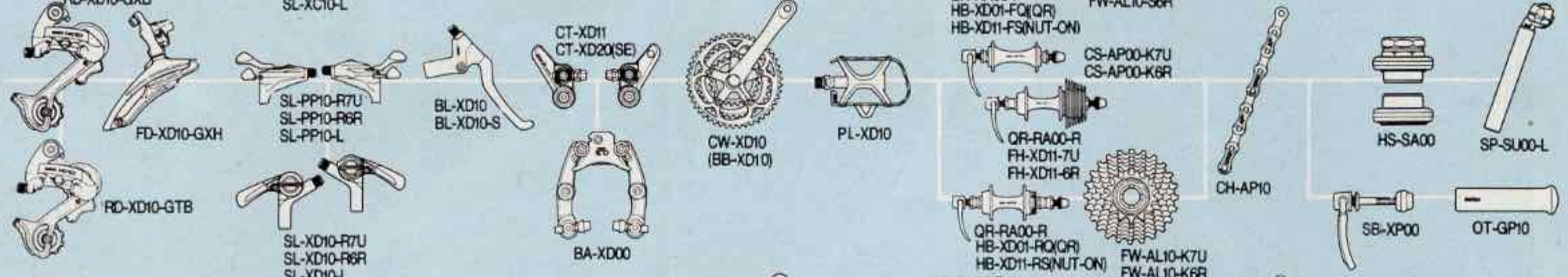

X-1

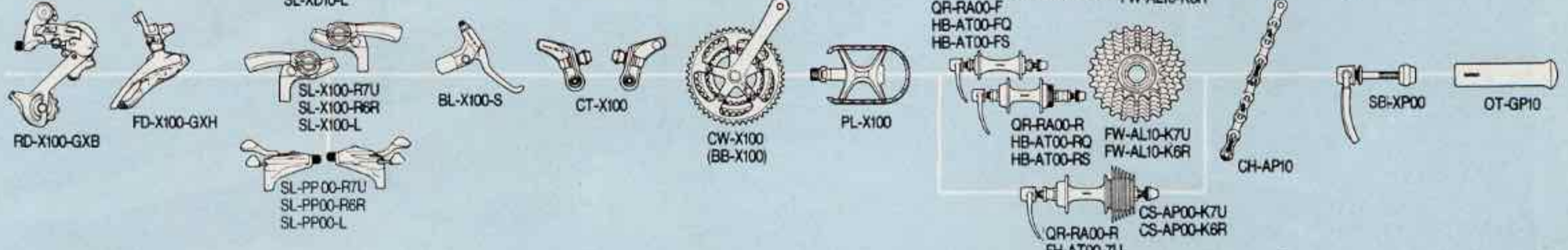

SUPERBE PRO

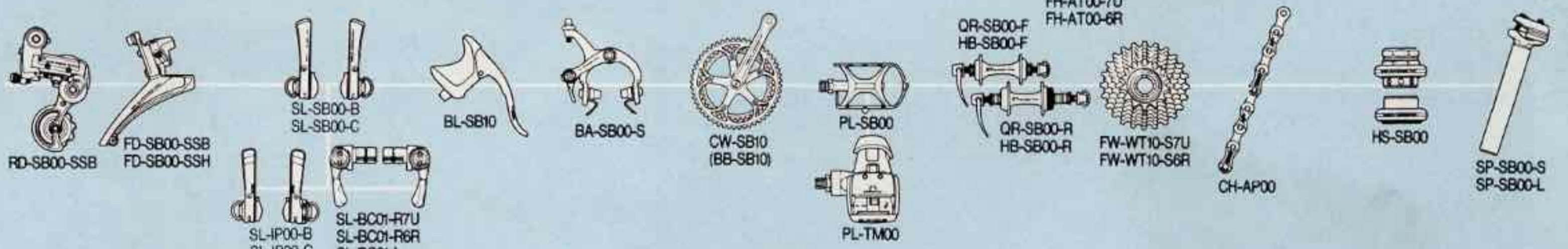

Sprint

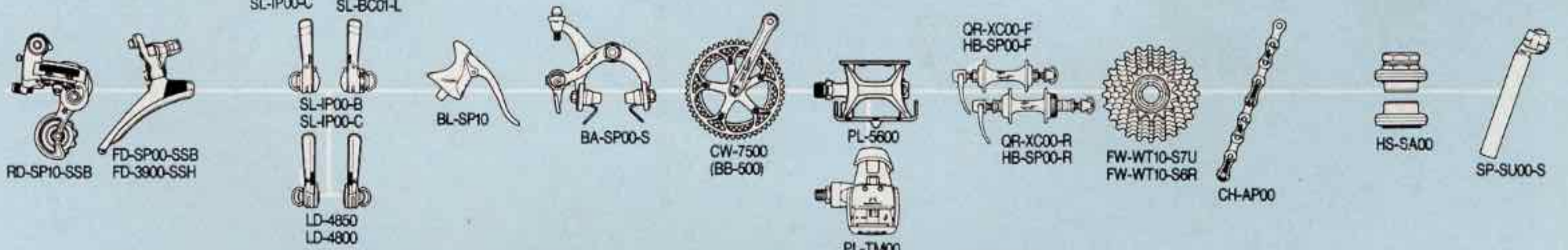

GPX

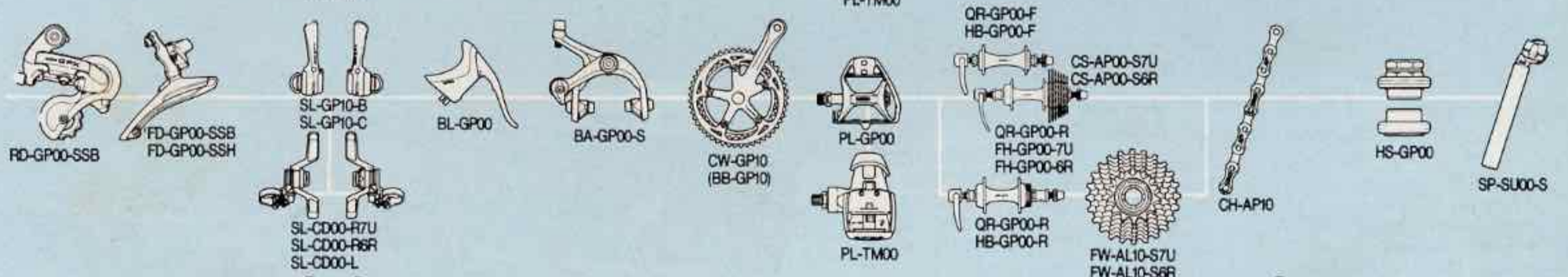

RADIUS

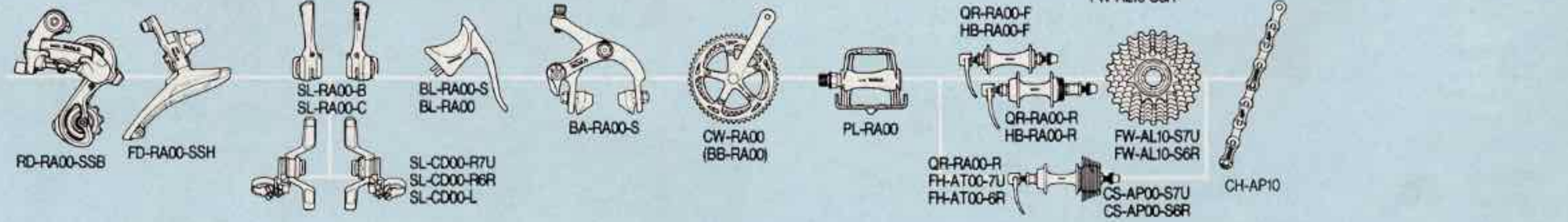

MAEDA INDUSTRIES, LTD.
97 Tannan, Mihara-Cho,
Minamikawachi-Gun, Osaka 587
Japan
Tel: (0723)61-1300 Fax: (0723)61-2300

SunTour, U.S.A., Inc.
75 Digital Drive, Novato, CA 94949 U.S.A.
Tel: (415)883-1220 Fax: (415)883-1267