



# HEAD SETS

TIOGA



MTB MASTER



## MTB MASTER

- Silver or black anodized
- Lightweight and strong Duraluminum material
- Triple-sealed mechanism
- 2mm thick CrMo ball race
- Protective resin cladding on upper and lower cups
- Weight: 136g



MTB EXPERT



## MTB EXPERT

- CP or black chrome plated
- Triple-sealed mechanism
- Protective resin cladding on upper and lower cups
- Weight: 164g



MTB BEARTRAP



## MTB BEARTRAP

- CP or black chrome plated
- Triple-sealed mechanism
- Beartrap loose-proof mechanism
- Weight: 158g



MTB I

## MTB-I

- CP or black chrome plated
- Triple-sealed, double-sealed and standard versions available
- Weight: 157g

MTB II

## MTB-II

- CP or black chrome plated
- Triple-sealed mechanism
- Loose-proof, with extra long threading
- Weight: 171g

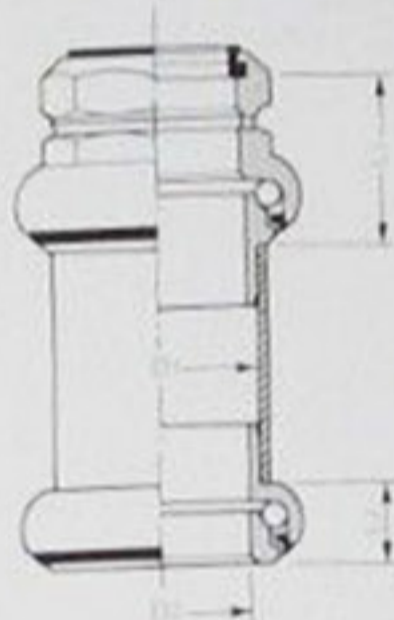

### ASSEMBLY DIMENSIONS

	L1	L2	STACK HEIGHT (L1+L2)	Di	Di
MTB MASTER	25.2	14.3	39.5	30.0	27.0
MTB EXPERT	23.5		35.5		
MTB BEARTRAP	26.0	12.0	38.0		
MTB-I	24.5		36.5		
MTB-II	23.0		35.0		

## DOUBLE HEAD LOCK NUTS



### DOUBLE LOCK

- Alloy version in silver or black anodized finish
- Steel version in CP or black chrome plated finish
- Loose-proof mechanism
- Water-proof mechanism
- Weight: 18g



# HANDLEBAR STEMS

TIGCA



**BAD TO THE BONE.**

## T-BONE

- CP or black chrome plated
- Sani-cut shaft
- Strong and lightweight Prestige CrMo
- Unique, sleek and exclusive tubular design
- Strong CrMo expander and binder bolt
- Light alloy wedge



## Internal brake cable routing type

- 105, 120, 135, 150mm stem extensions available

Photo: 120mm, 330g



## Vertical brake cable routing type

- 90, 105, 120, 135, 150mm stem extensions available

Photo: 120mm, 325g

## Standard type

- 90, 105, 120, 135, 150mm stem extensions available

Photo: 120mm, 296g

## TITANIUM EXPANDER BOLT

- Strong and lightweight
- Size:  $\varnothing 8\text{mm} \times 135\text{mm}$
- Weight: 28g



## TITANIUM BINDER BOLT

- Strong and lightweight
- Size:  $\varnothing 6\text{mm} \times 19\text{mm}$
- Weight: 3g



## SHIM

Shims available separately, as adapters for all standard 22.2mm clamp diameter handlebars

# HANDLEBARS



**I'M FINISHED  
BAR HOPPING!**

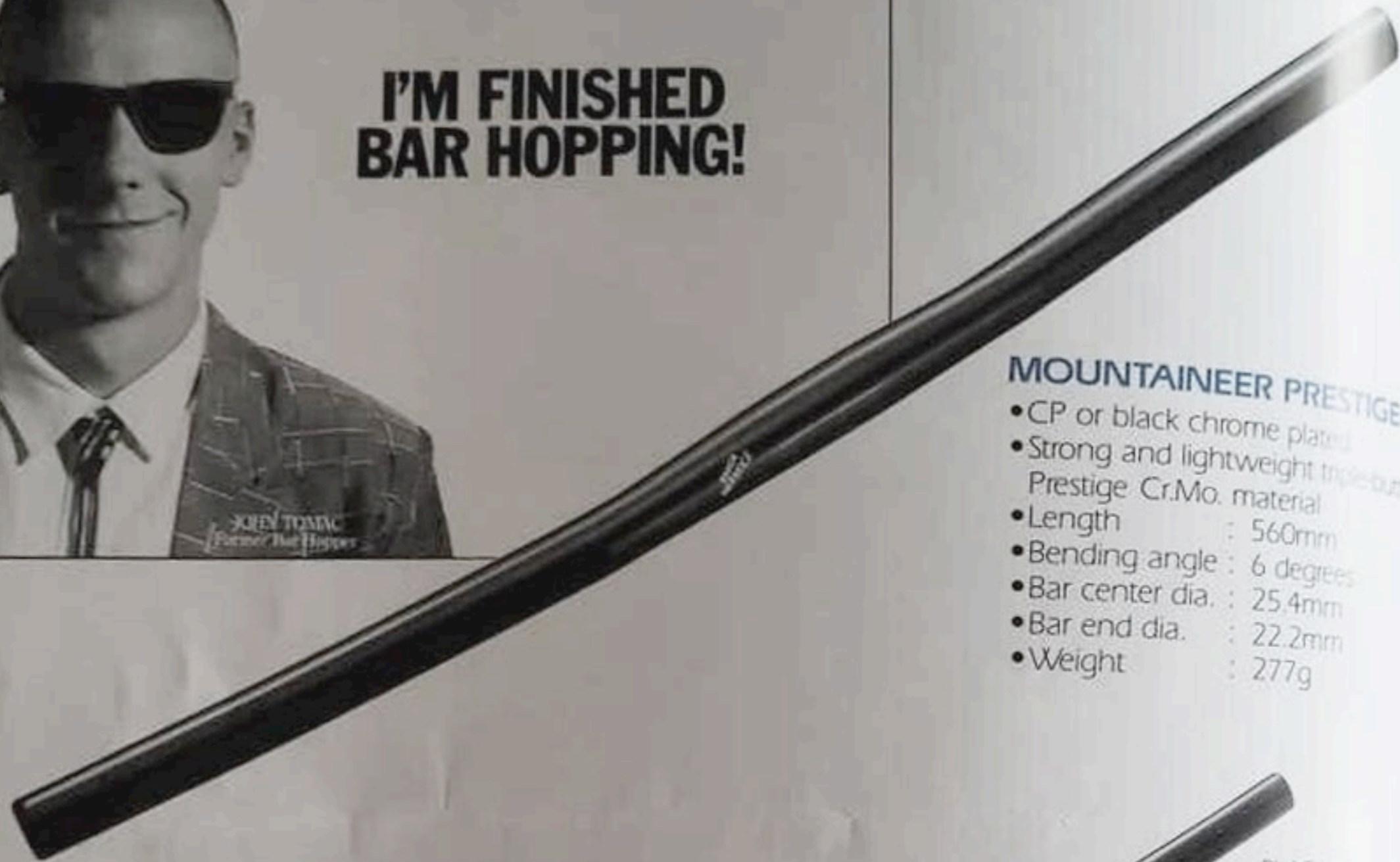

## MOUNTAINEER PRESTIGE-I

- CP or black chrome plated
- Strong and lightweight triple-butted Prestige Cr.Mo. material
- Length : 560mm
- Bending angle : 6 degrees
- Bar center dia. : 25.4mm
- Bar end dia. : 22.2mm
- Weight : 277g

## MOUNTAINEER MASTER TX

Hi-tech grey, silver or black textured finish  
Strong and lightweight aluminum alloy material

- Length : 600mm
- Bending angle : 6 degrees
- Bar center dia. : 25.4mm
- Bar end dia. : 22.2mm
- Weight : 270g

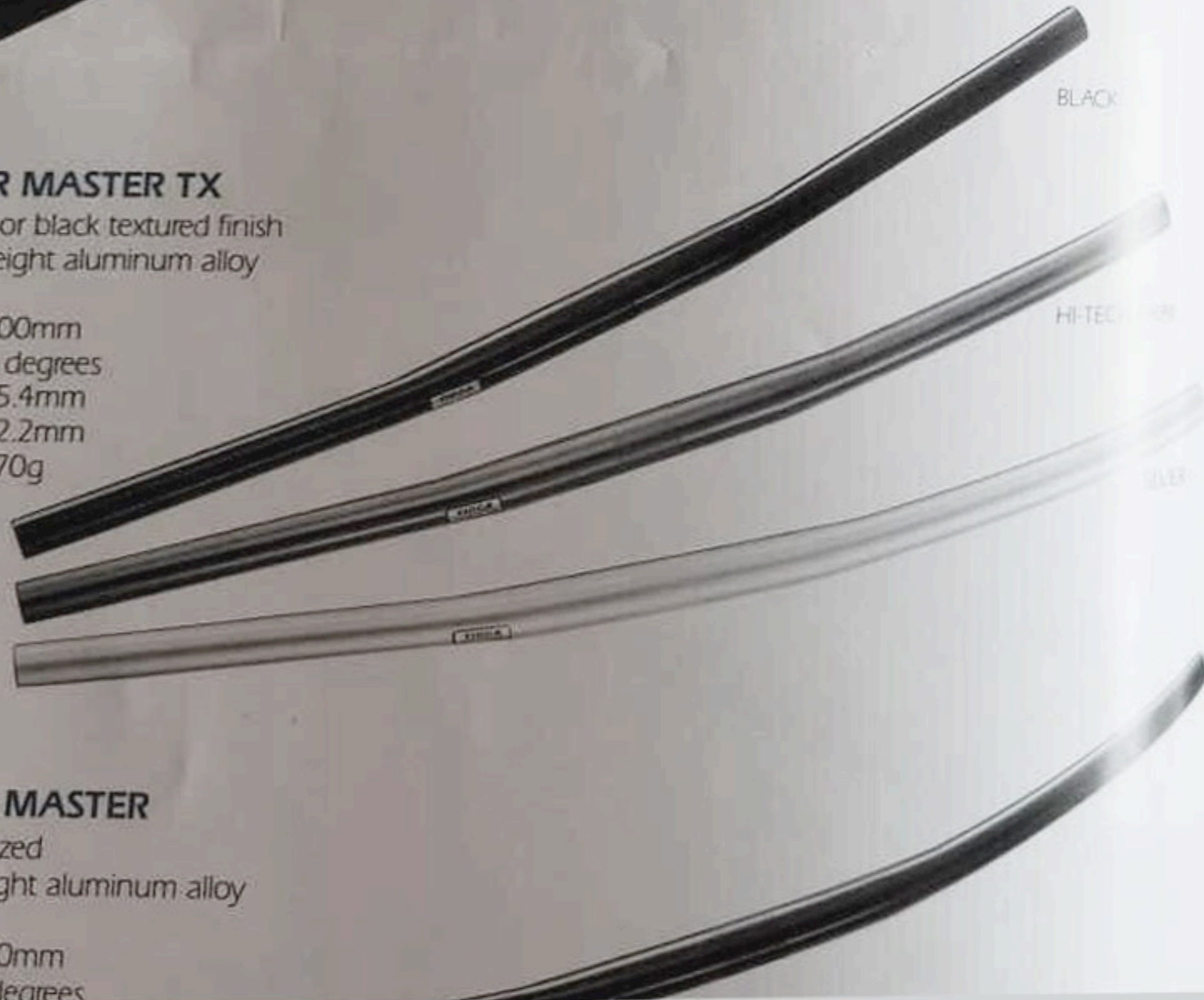

## MOUNTAINEER MASTER

Silver or black anodized  
Strong and lightweight aluminum alloy material

- Length : 600mm
- Bending angle : 6 degrees

## MOUNTAINEER-I

- CP or black electronic deposition painted
- Strong and lightweight Cr.Mo. material
- Length : 610mm
- Bending angle : 10 degrees
- Bar center dia. : 25.4mm
- Bar end dia. : 22.2mm
- Weight : 289g



## GRIPS



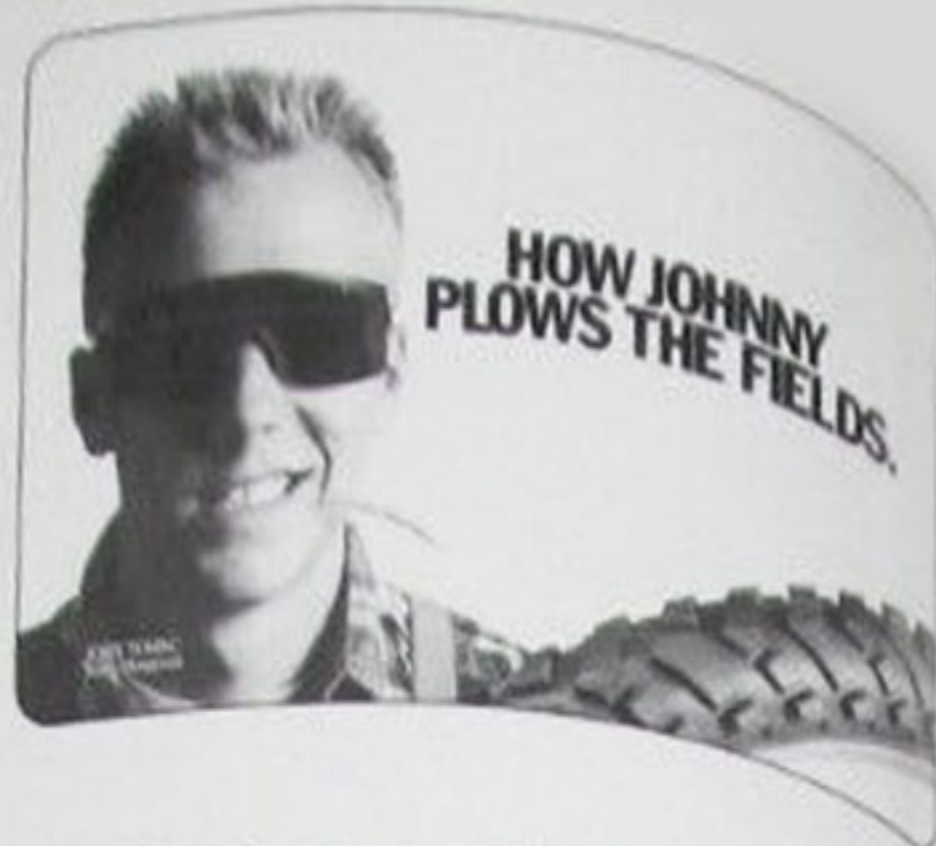

**HOW JOHNNY  
PLOWS THE FIELDS.**



**FARMER JOHN**

- 35/65PSI, in 24" x 1.95" and 26" x 1.95" sizes
- Uniquely designed paddle tread pattern for the best available hill-climbing rear tire
- Special Polyrubber compound provides excellent resiliency, traction and long tire life
- 130 end thin casing for light weight and agility
- Weight 24" x 1.95" : 696g/pc.  
26" x 1.95" : 720g/pc.

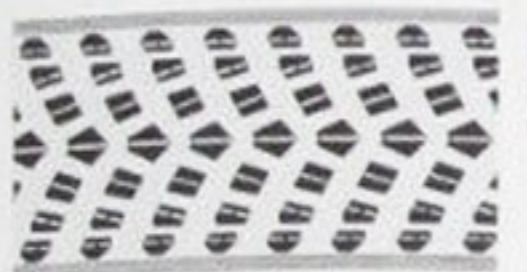

**FARMER JOHN'S  
COUSIN**

- 35/65PSI, in 24" x 1.95" and 26" x 1.95" sizes
- Special design, with a condensed tread pattern for superior directional control
- Special Polyrubber compound provides excellent resiliency, traction and long tire life
- 130 end thin casing for light weight and agility
- Weight 24" x 1.95" : 675g/pc.  
26" x 1.95" : 748g/pc.



**MEET  
FARMER JOHN'S  
COUSIN**



**FARMER JOHN'S  
NEPHEW**

- 35/65PSI, in 24" x 1.95", 26" x 1.50" and 26" x 1.95" sizes
- Uniquely designed paddle tread pattern for the best available all-round tire
- Special Polyrubber compound provides excellent resiliency, traction and long tire life
- Weight 24" x 1.95" : 688g/pc.  
26" x 1.50" : 510g/pc.  
26" x 1.95" : 734g/pc.

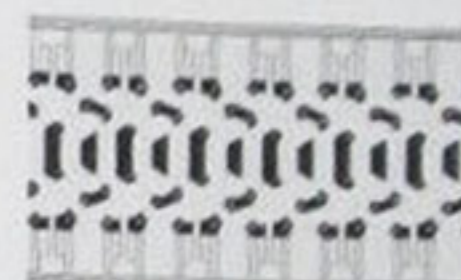

**MUD DAWG**

- 35/65PSI, in 26" x 1.95" size
- Uniquely designed tread pattern
- Tioga exclusive gapped side blocks
- Special Polyrubber compound provides excellent resiliency, traction and long tire life
- 130 end thin casing for light weight and agility
- Weight: 710g/pc.



**CITY SLICKER**

- 35/65PSI, in 26" x 1.50" and 26" x 1.95" sizes
- Unique canal-type tread pattern with high arc radius, for increased surface contact
- Special Polyrubber compound with superior adhesion and traction qualities
- 130 end thin casing for light weight and agility
- Weight 26" x 1.50" : 520g/pc.  
26" x 1.95" : 790g/pc.

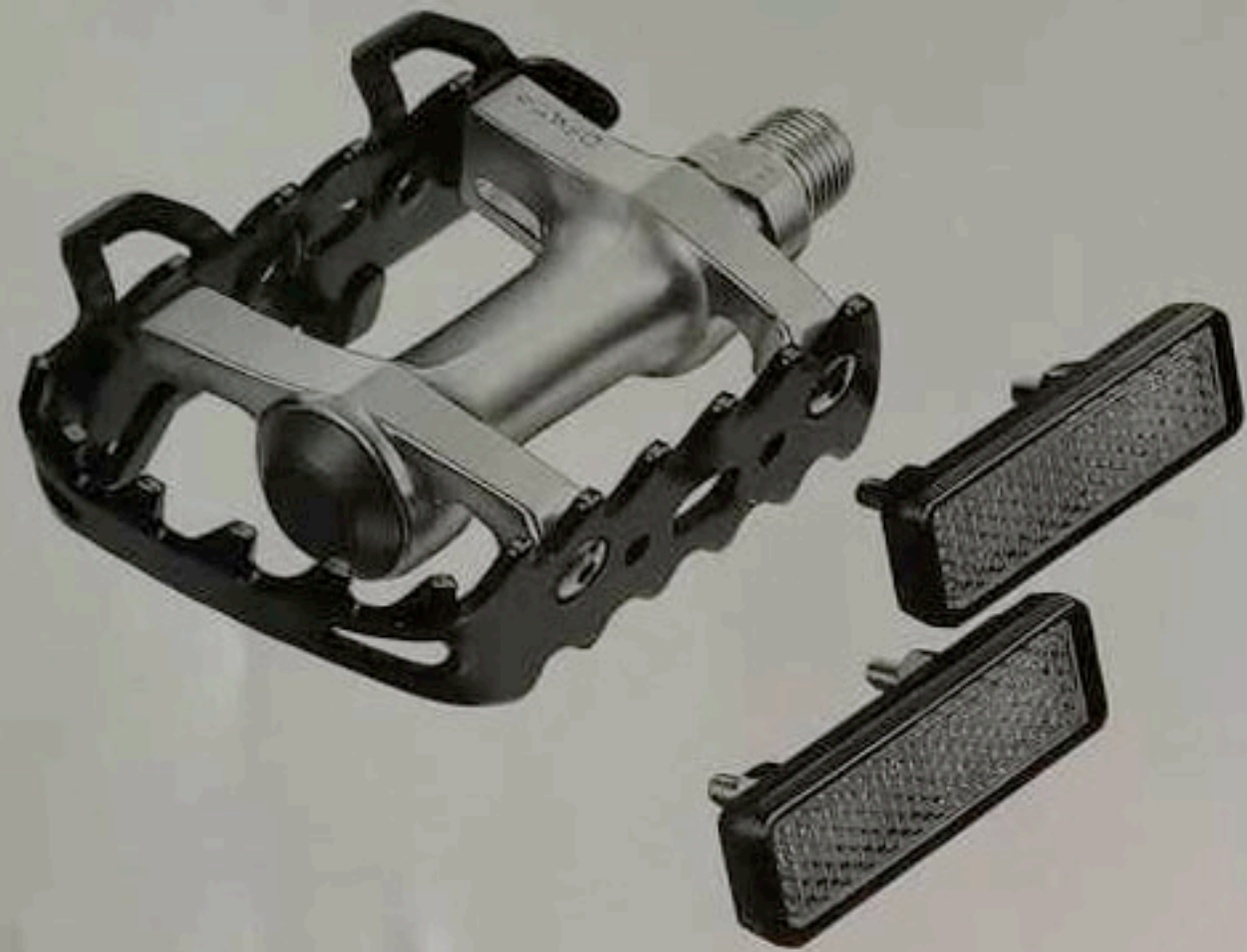

**SUREFOOT-I**

- Light alloy body with black steel cage
- Slant-cut cage enables riders to obtain a steeper cornering angle
- Specially designed strap nails prevent straps from slipping side to side, and prevent mud build-up by retaining them in a vertical position
- Unique double cage flips enable riders to quickly flip the cage to an upright position
- Angled cage notches effectively prevent foot slippage
- High quality Cr.Mo. spindle
- Sealed mechanisms resist moisture, mud and dust
- Weight: 498g/pr.



**SUREFOOT-II**

- Black resin with replaceable notched rings
- Lightweight
- Specially designed strap stopper
- Double cage flips
- Cr.Mo. spindle
- Weight: 320g/pr.

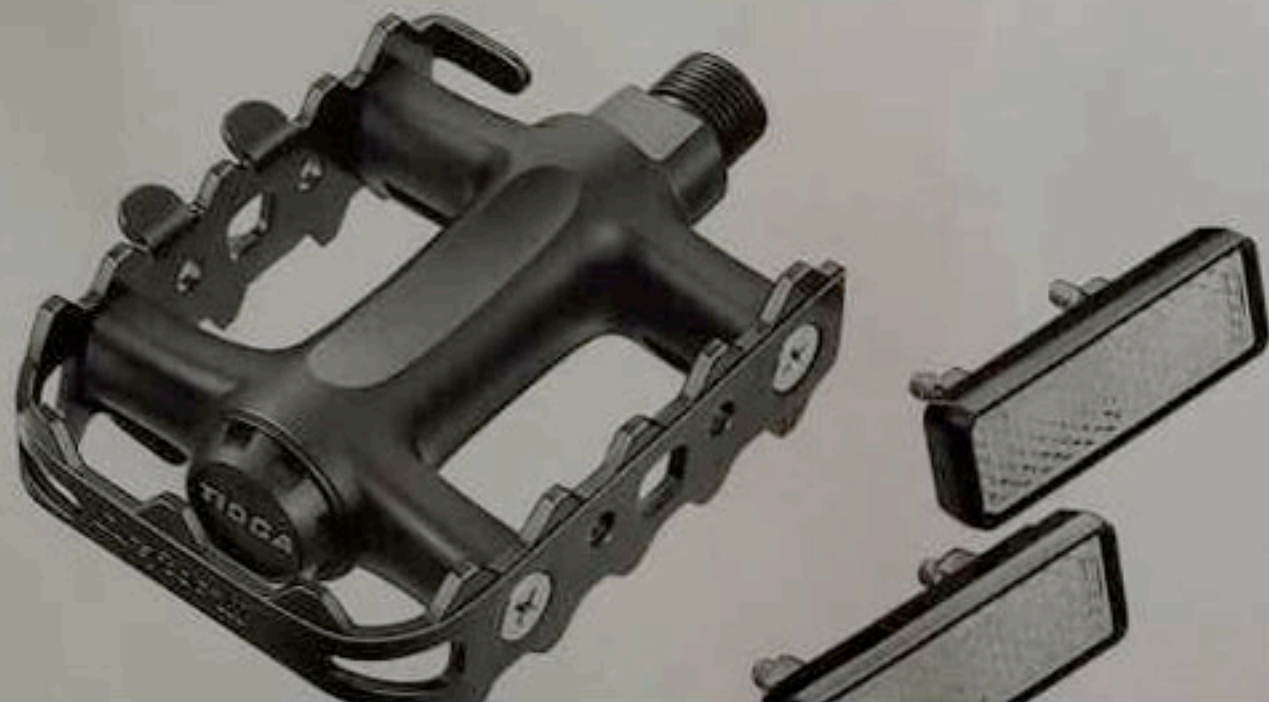

**SUREFOOT-III**

- Hi-tech grey with black cage
- Low-profile design
- Lightweight
- Double cage flips
- Cr.Mo. spindle
- Weight: 416g/pr.

**POWER**

- Black
- Polycarbonate
- Double strap
- Lightweight
- M and L

**TOGA**



## CARBO PILLAR

- Carbon black
- Strong and lightweight carbon fiber, with light alloy reinforcement tube
- Available in a wide variety of sizes, to fit all standard ATB frames: 24.7, 25.0, 25.4, 25.8, 26.4, 26.8, 27.0, 27.2mm
- Length: 300mm
- Weight: 253g (27.0mm)

## PRESTIGE PILLAR

- CP or black chrome plated
- Strong and lightweight Prestige post
- Unique and exclusive design, with tubular type clamp
- Continuously variable saddle angle adjustment
- Light alloy saddle mount
- Available in a wide variety of sizes: 26.6, 26.8, 27.0, 29.8, 30.2 or 30.4mm
- Lengths: 250, 300, 350 or 400mm
- Weight: 320g (26.8mm x 300mm)

## SEAT PIN

- CP or black electronic deposition painted
- Strong and durable Cr.Mo. material
- Quick release mechanism
- Universal type, with Tioga specially designed adapter spacers
- Soft resin lever cover
- Weight: 92g



# CABLE HANGER



- CP or black chrome plated
- Light alloy adjusting bolt
- Light alloy locking nut, with protective rubber ring
- Weight: 22g

# CABLES



## DUROCABLE

Universal Replacement Inner Wire

- Rust-proof stainless steel material, for longer life
- Tioga 7 x 7 braided construction (49 strands) for superior strength and durability
- Pre-stretched to avoid primary stretching and adjustment
- 1.2mm/1.8mm/2.0mm diameters available

## DUROCABLE

Universal Replacement Cable

- Special "Duracon" housing liner minimizes friction
- Flat-wound steel housing coil prevents cable compression during braking
- Tioga DUROCABLE stainless steel inner wire
- 75" x 60" universal size, with 5mm or 6mm diameter outer cables

# BOTTOM BRACKET PARTS

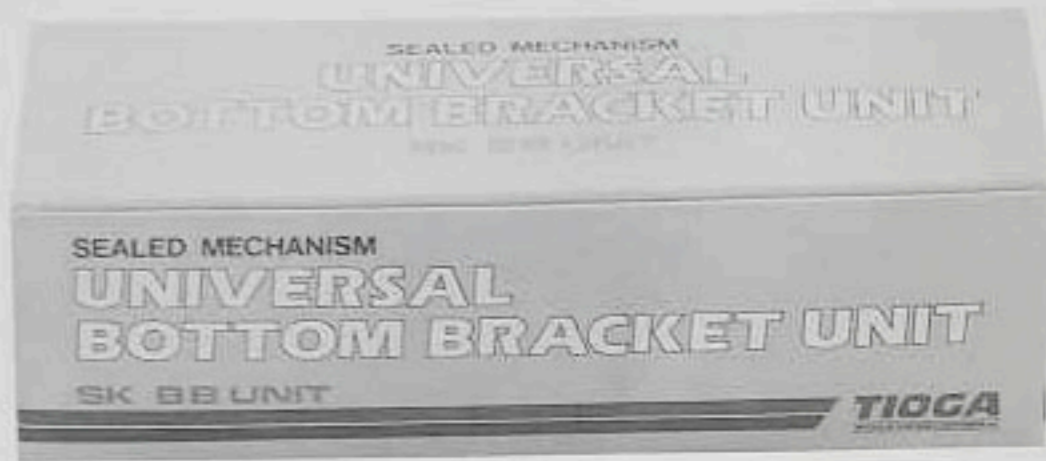

## SEALED B.B. UNIT

- Sealed bearing
- Internal dust seal
- Tioga special all-in-one design
- High quality boron steel cotterless axle, with 2 degree taper
- 3P or 3R type axles available



## B.B. AXLES

- Extra long, to suit 73mm BB shell
- Nut or bolt type available
- 2 degree taper
- Weight: 213g



BOLT TYPE

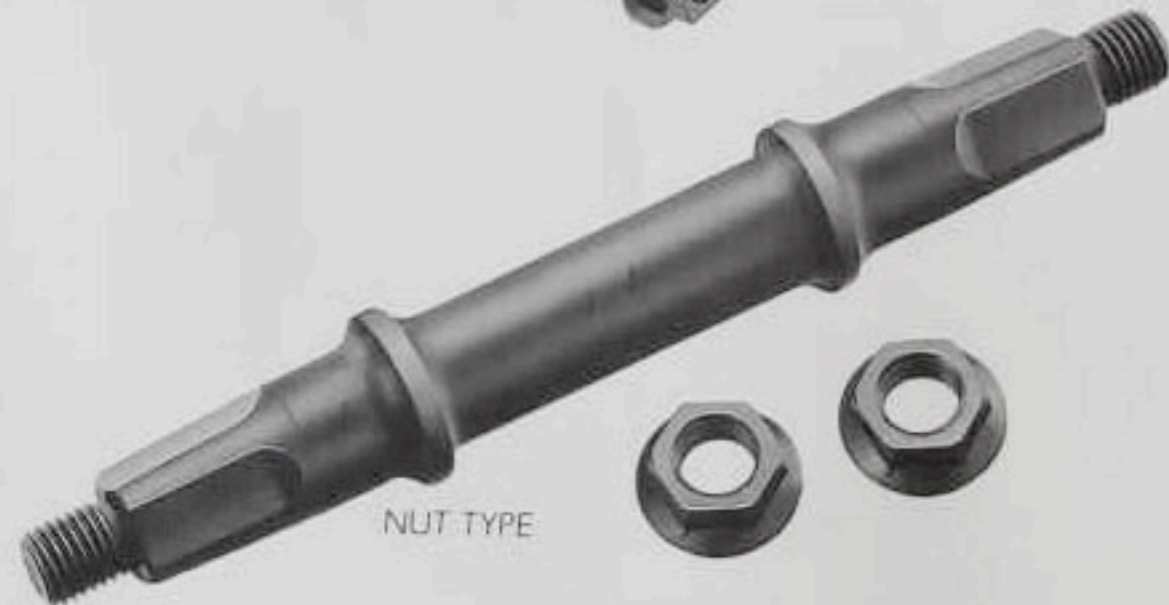

NUT TYPE

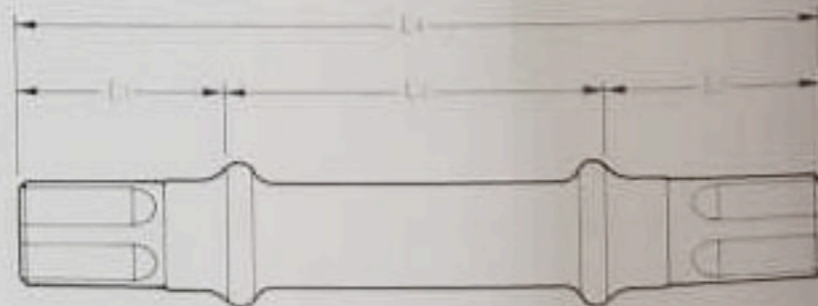

	L1	L2	L3	L4
7NL	32.0	57.0	33.5	122.5
7EL	35.0	57.0	36.0	128.0



## U-LOC



## WATCHDOG

- Black vinyl-covered
- Specially heat-treated cutters, hacksaw
- Cylindrical barrel picking
- \$1,000 guarantee
- 200mm and 300mm
- Complete with r...